

Nick's Discount
Medical Supply, LLC

"Quality of Life is our Business"



Why Nick's Discount Medical

A ONE-STOP shop with competitive pricing, premium quality products, and the highest level of service and support to help you prosper in today's competitive healthcare environment.

An accredited company that is committed to continuously improving every part of our company to provide our customers with the products, expertise, and tools needed to improve your business and increase your profits.

Professional knowledgeable sales staff that provides the highest level of customer satisfaction and provides insight into reimbursement support.

Nicks Discount
Medical Supply, LLC
PO Box 36024
Richmond, VA 23235
Phone: 804-378-0582
Fax: 804-378-0583

Table of Contents

AIDS FOR LIVING	3-9
BATH SAFETY	10-15
CPAP DEVICES & ACCESSORIES.....	73-77
DIABETIC SUPPLIES/RISK MANAGEMENT	40-42
HOSPITAL BEDS & ACCESSORIES	25-36
INCONTINENCE	43-44
MATTRESS & SUPPORT SURFACES	37-39
ORTHOTIC DEVICES	45-46
PAIN MANAGEMENT	47-52
PATIENT MONITORS.....	24
POWER WHEELCHAIRS & RELATED PRODUCTS	53-61
RESPIRATORY PRODUCTS	78-83
WALKING AIDS	16-23
WHEELCHAIRS & RELATED PRODUCTS	62-72

Emergency Response System Guardian Alert 911

- » Two-way system allows you to talk directly to a 911 operator
- » One Button Safety Protection
- » Freedom to live alone
- » No monthly fee; No long term contract commitments



Item #	Programmable Numbers	M.S.R.P.
EMS-30911	1	\$199.95
EMS-35911	4	\$299.95
EMS-35911-TD	Talking Display	\$59.95

Telemergency Alert Device

- » Wireless pendant button will automatically call 911 and up to 10 individuals in the order of preference until response
- » Optional daily alarm feature
- » Wireless phone answering with pendant will automatically activate speakerphone
- » Simple programming



Item #	Programmable Numbers
EMS-6406195	10



Day-Light Sky

- » Clinically proven technology meets stringent Bright Light Therapy standards
- » 99.3% UV filtered and safe
- » Glare-free diffusion lens and two 55 watt light tubes emit warm, white light and minimize potentially harmful blue rays
- » Height adjustable arm allows the user to set the appropriate height and angle for therapy
- » Two light settings make this light versatile for therapy and/or while doing everyday tasks
- » Flicker-free operation with the use of high electronic ballasts

HeartSine Samaritan® PAD 300P

- » Compact & Lightweight - 28-56% smaller than other AEDs on the market and weighing only 1.1kg
- » Easy to use —Audio & Visual Prompts guide the user step-by-step through the rescue process – 3 large, easy-to-see icons illuminate – “Attach pads,” “Do not touch the patient,” and “It is safe to touch the patient” to facilitate the rescue process.
- » Sophisticated SCOPE Biphasic waveform technology adjusts patient impedance to maximize effective shock delivery.
- » The Samaritan PAD has a rating of IP56 providing the 300P with the highest level of water resistance in the industry.
- » HeartSine’s practical Pad-Pak combines battery and electrodes into one cartridge – one date to monitor and only one item to replace on expiry or after use.
- » Drop tested in accordance with IEC 60601-1
- » Field upgradeable to the latest AHA/ERC guidelines
- » Automatic self-check
- » Suitable for adults and children; Pediatric-Pak available for 0-8 years of age (< 25kg or 55 lbs.)
- » Controls & electrodes are accessible even with your HeartSine samaritan PAD still in the case.
- » Integrated metronome prompts the CPR chest compression rate.
- » Events are recorded with the time, date, ECG trace & duration, shock delivery information, and CPR intervals. This information is downloadable to a PC with optional SAVER® EVO software.



AED-300P

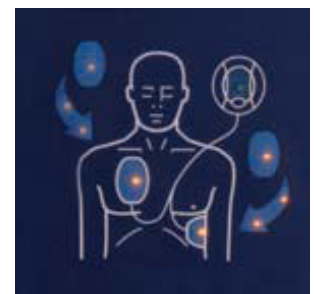

AIDS FOR DAILY LIVING

Telescopic Shoe Horn

- » Adjustable length: 27 $\frac{7}{8}$ " - 32 $\frac{3}{8}$ "
- » Comes with hanging storage hook hole
- » Guide feet into shoes without bending

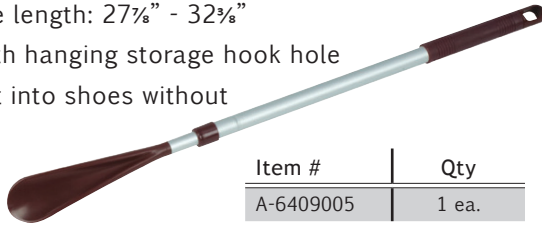

Item #	Qty
A-6409005	1 ea.

Leg Lifter

- » For moving legs to get out of a chair, wheelchair, bed or car
- » Large open loops at each end
- » Aluminium rod covered by 1" nylon webbing



Item #	Length	Qty
A-6408222	32"	1 ea.

Dressing Aid Stick

- » A push-pull double hook that assists in getting in and out of clothes
- » Small metal hook assists with zippers



Item #	Length	Qty
A-6408110	27"	1 ea.

Reach Extender Hip Kits

- » Contains four of the most popular assisting devices:
- » 24" Reacher
- » Deluxe Sock & Stocking Aid
- » 19.5" Shoe Horn
- » 22.5" Long-handled Bath Sponge



Item#	Description	Qty	M.S.R.P.	Sugg. HCPCS
A-78300	Dressing & Reaching Kit	1/ea.	\$75	A4649

Aluminium Reacher with Magnetic Tip

- » Aluminium frame
- » Maximum holding weight: 4 lbs
- » Magnetic tip picks up light weight metal objects



Item#	Size	Qty	M.S.R.P.	Sugg. HCPCS
A-REACH31	30"	6pcs/cs	\$29	A4649

Aluminium Reacher

- » This light weight reacher is specially designed with a full hand-grip; it allows the full use of all 4 fingers for easier dexterity(grip).



Item#	Size	M.S.R.P.	Sugg. HCPCS
A-REACH32	31"	\$29	A4649
A-REACH26	25"	\$29	A4649

Button Aid / Zipper Pull

- » Wood handle with button hole loop and a small metal hook on the opposite end for zippers
- » Assists in button and zipper fastening
- » Works with standard size buttons



Item#	Size	Qty
A-5131	8"	1 ea.

Red Bendable Utensils Kit

- » Ideal for people with restricted wrist or finger movement



Item #	Qty
A-THK4001	1 set of 4

Soft Touch Bendable Utensils

- » The built-up, soft-touch handle makes it easy to grasp and hold onto
- » Can be bent left or right
- » Stainless steel, dishwasher safe



Item #	Qty
A-TK11040	1 set of 4

Key Holder

- » Provides several grasping positions and excellent leverage
- » Fits up to 2 keys
- » Fits house keys and most car keys



Item #	Length	Qty
A-641-5412-10	5"	1

3-Key Turner

- » Designed to fit keys & give a larger grip for stronger leverage to turn
- » Keys hold when not in use
- » Easy to hold and store



Item #	Length	Qty
A-HA4110	4¾"	1

Food Plate Guard - Plastic

- » Prevents food from being pushed off plate
- » Dishwasher and Microwave safe



Item #	Size fit plate	Qty
A-T640-9012	6"~10"	1

Food Plate Guard - Stainless Steel

- » Prevents food from being pushed off the plate
- » Three spring action clips to secure the guard to the plate

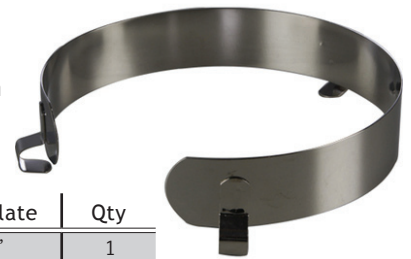

Item #	Size fit plate	Qty
A-TK15216M	9"~11"	1
A-TK15216S	6"~8"	1

Standard Tableware Kit

- » Standard Kit Includes: Large Scoop Bowl, Scoop Dish, Plastic Plate Guard, Egg Cup, Nose Cutout Cup, Drinking Cup



Item #	Qty
A-THK4002	1 set

Gas Cap Tool

- » For people with arthritis or hand injury to open gas caps on most makes of vehicles



- » 3 turning slots will allow use of most angles
- » Tool includes 2 additional head attachments

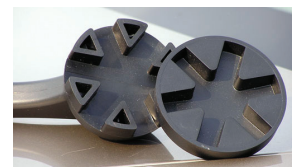

Item #	Qty
A-K21150	1 set

AIDS FOR DAILY LIVING

Expandable Door Hinge

- » Adds 2" to a doorway opening, granting barrier-free access to most wheelchairs



Item #	Size	Qty
A-640-2006	2" x 3½"	2/box

Seat Belt Handle

- » Provides a flexible extension handle, allowing user to grasp the seat belt while decreasing shoulder movement and reach extension
- » Overall length 9¼"
- » Handle length 5½"(approx.)
- » Glows in the dark to offer visibility at night



Item #	Qty
A-K21100	1

Handy Bar

- » Get in and out of a car safely
- » Universal
- » No-slip ergonomic grip



Item #	Pkg	Wt. limit	M.S.R.P
ST-3001	1 ea.	350 lbs.	\$34.99

Turning Cushion w/ Locking Positions

- » Swivels 360° for smooth and easy rotation in any direction
- » Four locking positions for added security
- » The base has 2 securing pads



Item #	Wt. limit	Pkg.
A-4784	250 lbs.	1 ea

Swing Door Opener

- » Living without barriers
- » Keyless entry
- » Easy installation



Item #	Qty
DM-50	1

Metro Car Handle

- » Protects against falls and makes standing or sitting easier
- » Securely fits into passenger or driver side door latch
- » Fits parallel to car for comfortable grip
- » Spare key compartment & window scraper



Item #	Pkg	Wt. limit	M.S.R.P
ST-2081	1 ea.	500 lbs.	\$29.99

Carcaddie

- » Offers a helping hand in & out of a car, van or truck
- » Easy installation and removal
- » Fits any vehicle with window frames
- » Adjustable length
- » No-slip rubber contour grip

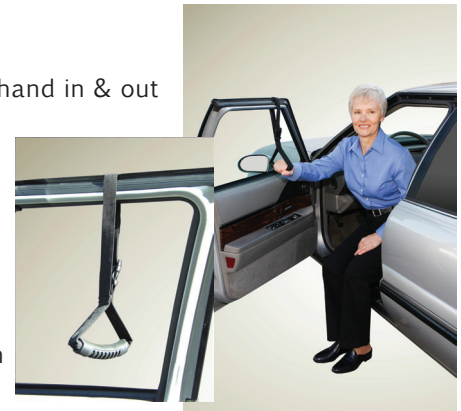

Item #	Size	Wt. limit	Pkg.	M.S.R.P
ST-2080	W: 5" L: 7"~16"	250 lbs.	1 ea.	\$16.99

AIDS FOR DAILY LIVING

Gait Belt

- » Made of heavy duty 2" wide cotton webbing to provide a secure hand hold for therapists and caregivers

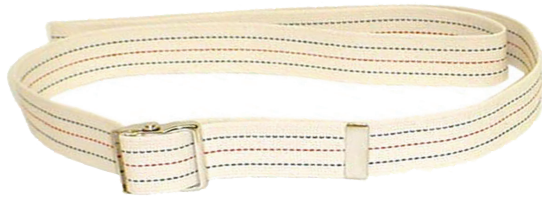

Item #	Size	Qty.	M.S.R.P.
A-K80315	48"	1	\$29
A-K80317	60"	1	\$39
A-K80318	72"	1	\$49

Pill Cutter

- » Cuts pills to smaller sizes
- » Size: 3¼"x1"



A-640-5437

7-Day Pill Holder

- » 7 day capacity
- » Easy management



A-PILLHOLDER

Foot Stool

- » Chrome plated steel frame
- » Non-slip textured matting stool surface
- » Stool platform dimensions: 10"x14"
- » Hand rail height: 34"



Item #	Wt. limit	Qty.	M.S.R.P.
PR-F1001-2	250 lbs.	2/case	\$59/ea
PR-F110-2	250 lbs.	2/case	\$69/ea

Grip-n-Assist-Belt

- » Getting in & out of beds, cars, or wheel-chairs
- » Convenient during post surgery
- » Support during movement
- » Provides support for medical professionals
- » One size fits all
- » Water resistance for use in baths & showers



Item #	Qty.	M.S.R.P.
A-GNA-W	1	\$89.95

Pill Crusher

- » Crushes tablets into powder
- » Size: 2"x 3¼"



A-640-5439

Pedal Exerciser

- » Work out your legs from the comfort of your own chair with this bicycle-type exercise
- » Unit can be placed on a table to exercise arms



Pedal Exerciser with Digital Display

Item #	Qty.	M.S.R.P.
EX101-4	4/case	\$54/ea
EX201-4	4/case	\$64/ea

Sheet Magnifier

- » Magnifies a standard sized page (8"x11")
- » Magnification: 2X



Item #	Size	Qty.
A-5998149-02	12" x 8"	1

AIDS FOR DAILY LIVING

Assist-A-Tray

- » Makes standing and sitting easy and safe
- » Multi-use laptop/TV tray with cup holder & utensil compartment
- » Swivel tray keeps items close
- » Length & height adjustable



Item #	Height of Tray	Size of Tray	Wt. Limit of Tray	Wt. Limit of Handle	M.S.R.P
ST-2050	26" to 32"	16"x18"	30 lbs.	250 lbs.	\$199.99

CouchCane

- » Makes standing and sitting easy and safe
- » Four pockets keep convenient items close by
- » Adjustable in length & height to fit either sides of chair
- » Works great with a lift chair



Item #	Height of Handle	Wt. Limit of Handle	M.S.R.P
ST-2001	34" to 40"	250 lbs.	\$129.99

Lever Extender

- » Extension handle for recliners
- » Places handle within easy reach
- » Makes raising and lowering leg rest easy



Item #	Length	Width	Pkg.	M.S.R.P
ST-3000	9"	7"	1 ea.	\$24.99

Blood Pressure Monitor



- » ARM (BPM-DI2002A)
- » Date and Time Display
- » Recalls 80 readings
- » Fully-Automatic
- » Measure Range: Pressure 30~280 mmHg, Pulse 40~199/min.
- » Accuracy: Pressure $\leq \pm 3$ mmHg, Pulse $\leq 5\%$
- » Cuff: M(22-32) L(32-42)
- » WRIST (BPM-DI2003R)
- » Date and Time Display
- » Measure Range: Pressure 30~280 mmHg, Pulse 40~199/min.
- » Accuracy: Pressure $\leq \pm 3$ mmHg, Pulse $\leq 5\%$

Item #	Description	M.S.R.P	Sugg. HCPCS
BPM-DI2002A	Arm, Medium Cuff	\$79	A4670
BPM-DI2002A-L	Arm, Large Cuff	\$99	A4470
BPM-DI2002A-C1	Cuff, for BPM-DI2002A	\$39	N/A
BPM-DI2002A-C2	Cuff for BPM-DI2002A-L	\$45	N/A
BPM-DI2003R	Wrist	\$69	A4460

Uplift Seat Assist



- » UL100/300
- » Portable, self powered Uplift™ Seat Assist
- » Lifts up to 80% of patient's weight
- » Self powered, no electricity required
- » PS3017
- » Lifts up to 100% of patient's weight
- » Electric
- » Easy to carry

Item #	Weight	Height (Open)	Size	Weight Limit	M.S.R.P	Sugg. HCPCS
UP-UL100	10 lbs	10"	19" x 17"	230 lbs	\$299.99	E0629
UP-UL300	10 lbs	10"	19" x 17"	350 lbs	\$299.99	E0629
UP-PS3017	12 lbs	10"	19" x 16"	300 lbs	\$329.99	E0628

AIDS FOR DAILY LIVING

Pride Lift Chair

- » Patented quiet and smooth lift system
- » Fire retardant (California spec: bulletin117)
- » Single-switch hand control



CP-TMR358

Item #	Back Width	Seat to Floor	Seat Depth	Seat Width	Top Back to Seat	Weight Capacity	Recline Position	M.S.R.P.	Sugg. HCPCS
CP-TMR358M	31"	20"	20"	20"	24½"	375 lbs	3	\$1,020	E0627
CP-TMR358L	33"	21"	22"	22"	25½"	375 lbs	3	\$1,070	E0627

Dalton Lift Chair

- » Features a wonderful blend of style and comfort
- » 3 - positions
- » Pillow back design
- » Available in microsuede and vinyl

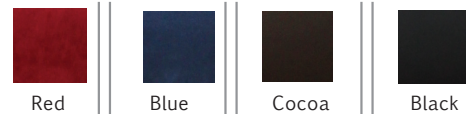

Item #	Back Width	Seat to Floor	Seat Depth	Seat Width	Top Back to Seat	Weight Capacity	Recline Position	M.S.R.P.
LC-106RED	30"	18"	18"	20½"	25"	350 lbs.	3	\$895
LC-106BLUE	30"	18"	18"	20½"	25"	350 lbs.	3	\$895
LC-106COCOA	30"	18"	18"	20½"	25"	350 lbs.	3	\$895
LC-106BLACK	30"	18"	18"	20½"	25"	350 lbs.	3	\$895

Recliner

- » For use in Dialysis, Oncology, Acute Care and other Clinical Environments
- Suggested HCPCS: E1031.



CW-653N
Clinical Recliner



CW-G584
Life Care Recliner (Gerichair)



CW-G529XL
Convalescent Recliner

Item #	Seat Height	Seat Width	Seat Depth	Overall Width	Weight	Weight Limit	Reline	M.S.R.P.
CW-G653N	21"	21"	20"	31"	101 lbs	275 lbs	Trendelenberg	\$1,095
CW-G584	20"	19"	20"	26"	85 lbs	275 lbs	3 position	\$525
CW-G529XL	23"	25"	20"	35"	112 lbs	450 lbs	3 position	\$1,122

BATH SAFETY

Shower Benches



BS-5000-2



BS-5002-2



BS-5005-2



BS-5003A-2



BS-S550HD-2

Item #	Height Range	Wt. limit	Pkg.	M.S.R.P
BS-5000-2	15"-20"	250 lbs.	2/cs	\$38/ea
BS-5002-2	13"-20"	220 lbs.	2/cs	\$46/ea
BS-5003A-2	13"-20"	250 lbs.	2/cs	\$75/ea
BS-5005-2	13"-20"	220 lbs.	2/cs	\$56/ea
BS-S550HD-2	17"-22"	500 lbs	2/cs	\$129/ea

Shower Commode Chair

- » 3" swivel caster wheels
- » Rear wheel locks
- » Padded seat
- » Fits over most toilets
- » Weight Limit: 220 lbs.
- » Sugg. HCPCS: E0164
- » M.S.R.P: \$225/ea



BS-SCM250W-2

3-in-1 All Purpose Commode

- » Can be used as a free standing commode, a toilet safety frame or a raised toilet seat with arms
- » Includes: seat, pail with lid, and splash guard
- » Seat height range: 17"-22"
- » Width between arms: 21"
- » Sugg. HCPCS: E0163



Item #	Seat Depth	Wt. limit	Pkg	M.S.R.P
COM-300-4	16"	300 lbs.	4/cs	\$125/ea

Universal Composite Bath Seat

- » Fits into most tubs
- » A smooth-edge notch provides convenient placement for a hand-held shower spray and drainage holes eliminate water pooling



Item #	Height Range	Wt. limit	Pkg.	M.S.R.P
BS-B671-C0	18"-23"	400 lbs.	1 set	\$75/ea

Rehab Shower Commode Chair

- » Durable aluminium and stainless steel components
- » Removable padded anti-bacterial seat & back
- » Swing up armrests & footrests
- » 24" rear wheels
- » Weight Capacity: 300 lbs.
- » Seat Width: 18"; Depth: 18"
- » Overall Width: 26.5"
- » M.S.R.P: \$1,099



BS-SHC930M

Folding Commode

- » Easily folds for storage or travel
- » Can be used as a free standing commode
- » Includes: pail with lid and splash guard
- » Sugg. HCPCS: E0163



Item #	Seat Size	Wt. limit	Pkg.	M.S.R.P
COM-520124403	17"x22.5"	300 lbs.	2/cs	\$125/ea

Drop-Arm Steel Commode

- » Pull-pin release mechanism drops the padded arm below seat level for unobstructed lateral transfers
- » Includes: pail with lid and splash guards
- » Seat height range: 16.5"-20.5"
- » Sugg HCPCS: E0165



Item #	Seat Size	Wt. limit	Qty.	M.S.R.P
COM-DA300-2	14"x15"	300 lbs.	2/ea	\$125/ea

Bariatric Drop-Arm Commode

- » Large opening in toilet seat
- » Easy-to-release drop arm mechanism
- » Width between arms: 24.5"
- » Extra-large padded deep seat provides comfort
- » Extra-large commode bucket
- » Sugg HCPCS: E0168



Item #	Seat Height	Seat Depth	Wt. limit	M.S.R.P
COM-DA650-1	19"	21"	650 lbs.	\$279/ea
COM-DA850-1	19"	21"	850 lbs.	\$359/ea

Commode Replacement Pail with Lid



Item #	Description	Pkg.	M.S.R.P
BS-M16	12 Gal. Pail with Lid	1 set	\$12/ea
BS-M16A	Splash Guard	1 set	\$12/ea
BS-M17	Pail with Lid 14"(L)x10"(W)x6"(D)	1 set	\$35/ea

Heavy Duty Steel Commode

- » Extra-wide 22.5" width between arms
- » Seat height range: 18.5"-22.5"
- » Sugg HCPCS: E0168



Item #	Seat Height	Wt. limit	Qty.	M.S.R.P
COM-500HD-2	18.5-22.5"	500 lbs.	1	\$179/ea

Extra Large Bariatric Drop-Arm Commode

- » Large opening in toilet seat
- » Easy-to-release drop arm mechanism
- » Extra large padded deep seat provides comfort
- » Extra large commode bucket
- » Sugg HCPCS: E0168



Item #	Seat Height	Seat Depth	Wt. limit	M.S.R.P
COM-DA1000-1	19"	21"	1000 lbs.	\$495/ea

Commode Replacement Seat & Lid

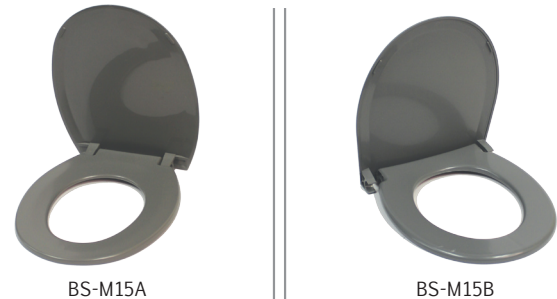

Item #	Description	Pkg.	M.S.R.P
BS-M15A	Clip on toilet seat & lid; Inner clip-on gap: 4 3/4"	1 set	\$24/ea
BS-M15B	Clip on toilet seat & lid gap 8"	1 set	\$24/ea

BATH SAFETY

Toilet Safety Frame

- » Adjustable width and height to fit most toilets
- » Flip back rails
- » Weight limit: 250 lbs.



Item #	Pkg.	Sugg. HCPCS	M.S.R.P
BS-TSRAIL-2	2 sets	E0243	\$70/ea

Raised Toilet Seat

- » Noncorrosive plastic seat
- » Available with or without safety armrests
- » Weight Limit: 250 lbs.



Item #	Description	Pkg.	M.S.R.P
BS-30200-1	with Arm	1/cs	\$74/ea
BS-30251-2	without Arm	2/cs	\$54/ea

Basic Transfer Bench

- » Blow-molded backrest and seat with textured surface
- » Non-slip surface with holes for water drainage
- » Rust-resistant aluminium
- » Frame can be adjusted to face right or left
- » Height adjustment: 18"-22"
- » Package: 2 sets/cs
- » Sugg. HCPCS: E0247



Item #	Tot. Width	Dep.	Wt. Limit	M.S.R.P
TB-5006-2	29"	18"	250 lbs	\$104/ea

Commode Assist

- » Can be used as bedside commode or over the toilet in your bathroom
- » Provides a gentle lift for 80% of your weight



Item #	Pkg.	Sugg. HCPCS	M.S.R.P
UP-CA2000	1 set	E0717	\$249.99/ea

Vinyl Cushion Toilet Seat

- » Attaches to top of toilet seat with hook and loop closures
- » Fits most standard size toilet seats
- » Foam padding minimizes pressure points
- » Seat thickness (center): 4"



Item #	Description	Pkg.
A-5201247-19	4" toilet seat cushion	1 ea.

Universal Transfer Bench

- » Features a comfortable backrest with 2 built-in handles for safe positioning
- » Drainage holes to eliminate water pooling
- » Height adjustment: 17.5" - 22.5"



Item #	Dimensions	Wt. Limit	Pkg.	M.S.R.P
TB-B170-C0	29¾"(W) x 19"(D) x 33"(H)	400 lbs.	1/cs	\$199

Deluxe Padded Transfer Bench

- » Vinyl padded seat and back provide comfort
- » Rust-resistant aluminium frame
- » Can be adjusted to face right or left
- » Height adjustment: 18"-22"
- » Package: 2 sets/cs.
- » Sugg. HCPCS: E0247



Item #	Tot. Width	Dep.	Wt. Limit	M.S.R.P
TB-300P-2	29"	18"	300 lbs	\$114/ea

Heavy Duty Transfer Bench

- » Blow-molded backrest and seat with textured surface
- » Non-slip surface with holes for water drainage
- » Rust-resistant aluminium frame
- » Can be adjusted to face right or left
- » Height adjustment: 18.5"-22.5"
- » Weight limit: 400 lbs
- » Sugg. HCPCS: E0248



Item #	Tot. Width	Dep.	Pkg	M.S.R.P
TB-5009HD-2	30.5"	21"	2 sets/cs	\$139/ea

Sliding Transfer Bench

- » Seat slides side-to-side
- » Comes with commode cut-out
- » Adjustable legs with suction cups
- » Seat dimensions: 19"(w)x15"(d)
- » Height adjustment: 19"-23"
- » Sugg. HCPCS: E2048



Item #	Tot. Width	Wt. Limit	M.S.R.P
TB-67311	37"	400 lbs.	\$249/ea

Padded Transfer Bench with Commode Opening

- » Vinyl padded seat and back provide comfort
- » Rust-resistant aluminium frame
- » Can be adjusted to face right or left
- » Height adjustment: 18"-22"
- » Sugg. HCPCS: E0247



Item #	Tot. Width	Dep.	Wt. Limit	M.S.R.P
TB-300U-P	29"	18"	300 lbs	\$149/ea

Heavy Duty Transfer Bench

- » Blow-molded backrest and seat with textured surface
- » Non-slip surface with holes for water drainage
- » Can be adjusted to face right or left
- » Height adjustment: 18.5"-24.5"
- » Weight limit: 500 lbs
- » Sugg. HCPCS: E0249



Item #	Tot. Width	Dep.	Pkg	M.S.R.P
TB-600-2	30.5"	21"	2 sets/cs	\$175/ea

Commode Liners

- » Solution for cleaning and sanitation
- » Holds up to 2 quarts of liquid
- » Easy disposal
- » Reduces spills and odors
- » Eliminates messy commode cleaning



Item #	Dimension	Pkg.
COM-B709-00	11.5"x0.1"x19"	24 units/cs

BATH SAFETY

PVC Shower Commode Chair

- » Healthcare grade PVC material inhibits the growth of bacteria
- » Rust-proof frame
- » Comes with anti-slip grips and rust-proof casters
- » Available in 18", 20", 22" (Internal width)
- » Seat height: 21"



Item #	Description	Wt. Limit	Pkg.
PVC-COM1183	Standard 18"	300 lbs.	1 ea.
PVC-COM1183KD	Knock Down 20"	300 lbs.	1 ea.
PVC-1223	22" Wide seat chair	300 lbs.	1 ea.

Textured Wall Grab Bars

- » Textured diamond knurled gripping area
- » Rust-proof stainless steel construction
- » Professional installation required
- » Retail box



Item #	Size	Sugg. HCPCS	M.S.R.P
BS-H212-1	12"	E0241	\$20
BS-H216-1	16"	E0241	\$21
BS-H218-1	18"	E0241	\$22
BS-H224-1	24"	E0241	\$24
BS-H232-1	32"	E0241	\$28

Bathtub Rails

- » Wide contact area for firm grip and even weight dispersion
- » Ideal for use on fiberglass tubs
- » Attaches to tub via mounting clip
- » P.E. Coated



BS-H101-1



BS-H102-1

Item #	Sugg. HCPCS	M.S.R.P
BS-H101-1	E1399	\$49
BS-H102-1	E1399	\$47

PVC Reclining Shower Chair

- » 20" Internal
- » 24" External
- » 21" Seat height
- » Weight Capacity: 325 lbs.



PVC-REC193

Bathtub Lift

- » Backrest automatically returns to the upright position when the bath lift is returned to the starting position
- » Adjustable recline angle from 12° to 22°
- » Anti-slip cover mat
- » Rustproof stainless frame
- » Smart battery monitoring system
- » Seat dimensions: 15.4"x19.7" (excluding side flaps)



Item #	Backrest	Seat Height	Weight	Weight Limit	M.S.R.P
PL303	23"x15.4"	2.9"-16.5"	32.5 lbs.	300 lbs.	\$995

Suction Cup Grab Bars

- » Suctions to any nonporous surface
- » Contoured handle
- » Push levers down to attach to surface, flip up to remove
- » Warning! Not to be used to support body weight

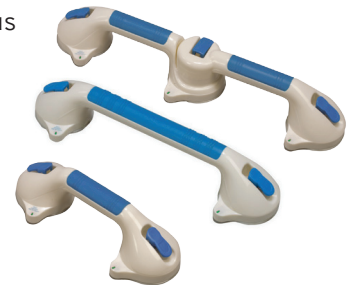

Item #	Size	Pkg.	M.S.R.P.
A-52115601912	12"	1/ea.	\$39
A-52115601916	16"	1/ea.	\$49
A-52115601924	24"	1/ea.	\$59

Security Pole

- » Tension-mounted floor-to-ceiling safety pole makes standing easy
- » Fits ceiling heights 7'-10'

Security Pole & Curve Grab Bar

- » Security pole & pivoting grab bar with 4 different grips
- » Fits ceiling heights 7'-10'



Item #	Color	Pkg.	M.S.R.P
ST-1100	Black or White	1/ea.	\$199.99
ST-1150	Black or White	1/ea.	\$199.99

Inflatable Bed Shampoo Basin

- » Designed to wash hair easier in bed
- » Extra deep basin
- » Compact storage

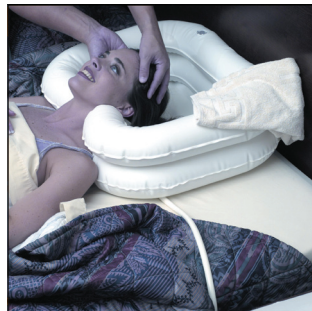

Item #	Dimension	Pkg.
BS-5408085	24"x20"x8"	1/ea.

E-Z Stretch Cast Protectors

- » Stretch easily over cast
- » Self-seal tightly around arm or leg with no tape or straps
- » Keep casts or bandages dry while showering or bathing



BS-P206-00



Item #	Dimension	Description	Pkg.
BS-P250-00	9"x20"	Fits most kid and adult arms	6/cs
BS-P206-00	15.28"x24"	Fits most kid and adult legs	6/cs

Hand Held Shower

- » Includes diverter valve
- » Can be used with either traditional shower head or shower spray with on/off switch
- » 72" hose



Item #	Pkg.	Sugg. HCPCS	M.S.R.P
BS-SH910	1/cs	E024	\$45

Medicine Organizer

- » Designed to organize medicine bottles and other items
- » Very useful with 18 compartments of varying sizes



Item #	Dimension	Pkg.	M.S.R.P
ACR-H1004	11¼"x5¾"x4¾"	1/ea.	\$17.95

Multiple Function Organizer

- » Designed to organize the glucometer and accessories
- » Very useful with 9 compartments of varying sizes



Item #	Dimension	Pkg.	M.S.R.P
ACR-H3071	7½"x6½"x4¼"	1/ea.	\$19.95

First Aid Organizer



Item #	Dimension	Pkg.	M.S.R.P
ACR-H3070	11½"x7½"x4½"	1/ea.	\$24.50

WALKING AIDS

Rollator - Standard

- » Flip up curved padded backrest
- » Handle height adjustment: 32"~36"
- » Loop-lock hand brakes
- » Width between handles: 17.5"
- » Seat dimension: 12"x12"
- » Basket dimension: 14"x8"x6"
- » Net weight without basket: 18 lbs.
- » Weight capacity: 250 lbs.
- » Sugg. HCPCS: E0143 + E0156



Item #	Color	Seat Height	Wheel Size	M.S.R.P
AR-4606AR	Burgundy	20.5"	6"	\$249
AR-4606BL	Blue	20.5"	6"	\$249

Rollator - Standard

- » Flip up curved padded backrest
- » Handle height adjustment: 32"~36"
- » Loop-lock hand brakes
- » Width between handles: 17.5"
- » Seat dimension: 12"x12"
- » Basket dimension: 14"x8"x4"
- » Net weight without basket: 18 lbs.
- » Weight capacity: 250 lbs.
- » Sugg. HCPCS: E0143 + E0156



Item #	Color	Seat Height	Wheel Size	M.S.R.P
AR-4609AR	Burgundy	20.5"	8"	\$249
AR-4609BL	Blue	20.5"	8"	\$249

Rollator - Light Weight

- » Flip up curved padded backrest
- » Handle height adjustment: 32"~36"
- » Loop-lock hand brakes
- » Width between handles: 17.5"
- » Seat dimension: 12"x12"
- » Bag dimension: 14"x7¾"x6"
- » Net weight with bag: 14 lbs.
- » Weight capacity: 220 lbs.
- » Sugg. HCPCS: E0143 + E0156



Item #	Color	Seat Height	Wheel Size	M.S.R.P
AR-4600AAR	Burgundy	20.5"	6"	\$299
AR-4600ABL	Blue	20.5"	6"	\$299

Rollator - Traditional with Tray

- » Handle height adjustment: 31"~38"
- » Loop-lock hand brakes
- » Width between handles: 17"
- » Tray size: 15½"x10"x1" deep
- » Seat dimension: 15"x8½"
- » Basket dimension: 15¾"x11¾"x7"
- » Net weight without basket: 24 lbs.
- » Weight capacity: 280 lbs.
- » Sugg. HCPCS: E0143 + E0156



Item #	Color	Seat Height	Wheel Size	M.S.R.P
AR-4608AR	Burgundy	24"	8"	\$249
AR-4608BL	Blue	24"	8"	\$249

Rollator - Ultra Light Weight Hemi

- » Straight padded backrest
- » Handle height adjustment: 28"~32¾"
- » Loop-lock hand brakes
- » Width between handles: 17.5"
- » Seat dimension: 12"x12"
- » Basket dimension: 14"x8"x6"
- » Net weight without basket: 12.8 lbs.
- » Weight capacity: 220 lbs.
- » Sugg. HCPCS: E0143 + E0156



Item #	Color	Seat Height	Wheel Size	M.S.R.P
AR-4100AR	Burgundy	18.5"	6"	\$299
AR-4100BL	Blue	18.5"	6"	\$299

Rollator - 3 Wheel

- » 3 wheel maneuverable design
- » Loop-lock hand breaks
- » Handle height adjustment: 30¼"~35¼"
- » Width between handles: 15"
- » Pouch dimension: 12½"x11"x14¼"
- » Tray dimension: 11¼"x9½"x¾"
- » Basket dimension: 9"x10½"x (3½"~10¼")
- » Net weight without basket: 16 lbs.
- » Weight Capacity: 250 lbs.
- » Sugg. HCPCS: E0143



Item #	Color	Wheel Size	Pkg.	M.S.R.P
AR-3000-2	Red	8"	2 set/cs	\$199

Rollator with Weight Activated Brake System

- » Weight activated brakes engage when weight is transferred to handle bars or seat
- » Moderate-to-good stability is required to use weight active break system which is non-locking
- » Width between handles: 17.5"
- » Seat dimension: 12"x12"
- » Weight capacity: 250 lbs.
- » Sugg. HCPCS: E0143+E0156



Item #	Color	Seat Height	Wheel Size	M.S.R.P
AR-4200RED	Burgundy	22"	5"	\$249
AR-4200BL	Blue	22"	5"	\$249

Bariatric Rollator

- » Straight padded backrest
- » Loop-lock hand brakes
- » Handle height adjustments: 33½"~37½"
- » Width between handles: 22"
- » Seat size: 18½"x14"
- » Basket size: 20"x8¼"x5"
- » Net weight without basket: 28 lbs.
- » Weight capacity: 450 lbs.
- » Sugg. HCPCS: E0149+E0156



Item #	Color	Seat Height	Wheel Size	M.S.R.P.
AR-5000RED	Red	22"	8"	\$445

Extra Heavy Duty Aluminium Rollator

- » Straight padded backrest
- » Net weight without basket: 20 lbs.
- » Handle height adjustments: 35"~39½"
- » Width between handles: 22½"
- » Seat size: 18"x13½"x2"
- » Basket size: 20¾"x9"x5½"
- » Weight capacity: 400 lbs.
- » Sugg. HCPCS: E0149+E0156



Item #	Color	Seat Height	M.S.R.P
AR-46402AR	Burgundy	22"	\$350
AR-46402BL	Blue	22"	\$350

Baskets - for 4 Wheel Rollators



AR-4608BASK



AR-4606BASK



AR-4601BASK



AR-46400BASK



AR-46402BASK



AR-5000BASK

Item #	Size (W x D x H)	Fit For
AR-4608BASK	16"x12"x7" w/ handle	Traditional
AR-4606BASK	14"x8"x6" w/ attachment & handle	Standard
AR-4601BASK	14"x9"x5½" w/ attachment	Standard
AR-46400BASK	20"x9"x5½" w/ attachment	Heavy Duty
AR-46402BASK	20¾"x9"x5½" w/ attachment & handle	Heavy Duty
AR-5000BASK	20"x8¼"x5" w/ attachment & handle & button notch	Bariatric

Baskets & Bag - for 3 Wheel Rollators

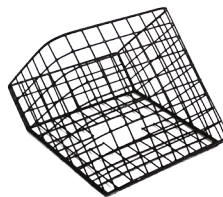

AR-3000BASK



AR-3000BAG



AR-3000TRAY

Item #	Size (W x D x (h1 - h2))
AR-3000BASK	9½"x9½"x(3½"-10¼")
AR-3000BAG	12½"x11"x14¼"
AR-3000TRAY	11"x10"x¾"

Bag & Tray - for 4 Wheel Rollators



AR-4600BAG



AR-46401BAG



AR-4608TRAY

Item #	Size (W x D x H)	Fit For
AR-4600BAG	14"x7¾"x6"	Standard
AR-46401BAG	20¾"x5"x10½"	Heavy Duty
AR-4608TRAY	15½"x10"¾"x¾"	Traditional

WALKING AIDS

Seat for Standard Rollators

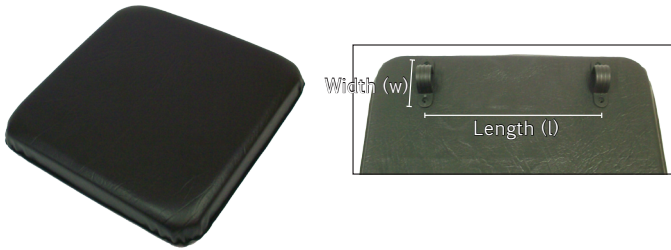

Item #	Seat Size	Clamp Distance	M.S.R.P
AR-4601SEAT	Padded: 12¼" x 14" x 1"	1¾"(w)x6"(l)	\$24
AR-4606SEAT	Padded: 12" x 12" x 1½"	1¾"(w)x7¾"(l)	\$24

Seat for Heavy Duty Rollators

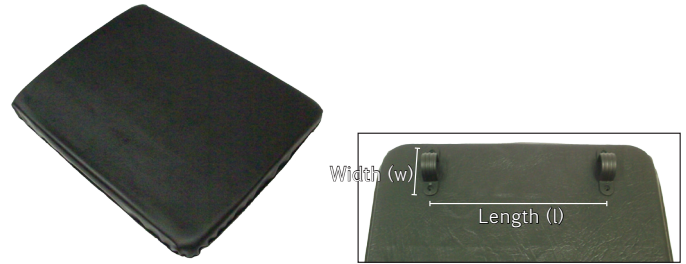

Item #	Seat Size	Clamp Distance	M.S.R.P
AR-46401SEAT	23"x11"x1¼"	1¾"(w)x12"(l)	\$29
AR-46402SEAT	18¼"x13½"x 1¾"	1¾"(w)x8"(l)	\$29
AR-5000SEAT	18"x14"x 1¾"	1¾"(w)x10¼"(l)	\$29

Wheels for Rollators & Accessories



Item #	Description	M.S.R.P
AR-30WHL8	8"x 2" PU (200 x 80) with 608Z Bearing Flanged	\$29
AR-46401WHL8	8"x 2" PU (200 x 80) with 608Z Bearing Flanged	\$29
AR-5000WHL8	8"x 2" PU (200 x 80) with 608Z Bearing Flanged	\$29
AR-4609WHL8	8" x 1½" PU Tire with 608Z Bearing Flanged	\$29
AR-46400WHL8	8" x 1" PU Tire with 608Z Bearing Flanged	\$29
AR-46402FWHL8	8"x 1½" Solid Caster with 608Z Bearing Flanged, Small, Front	\$29
AR-46402RWHL8	8"x 1½" Solid Caster with 608Z Bearing Flanged, Rear	\$29

Item #	Description	M.S.R.P
AR-4601WHL6	6" x 1" Caster with Bearing	\$16
AR-4606WHL6	6" x 1" Caster with Bearing	\$16
AR-4200WHL5	5" x 1" Caster with Bearing	\$16
AR-4600-1106	Plastic Seat Clamp 5/8"(w) x 15/16"(h)	\$2.99
AR-4600-1107	Plastic Seat Clamp 7/8"(w) x 1"(h)	\$2.99
AR-4601HDF-L/R	Grip for Rollator, Left/Right	\$2.99
AR-4606KNOB	Height Adjustable Knob/Bolt	\$4.95
AR-4608-LKLEVER	Height Adjustable Lever	\$4.95
AR-4200HANDLE	7/8"(diameter) Handle Bar	\$10

Rollator Brakes & Wheel Accessories



AR-4601BK-L/R



AR-5000LBK-L/R



AR-3000LBK-L/R



AR-4606LBK-L/R



AR-46401LBK-L/R



AR-46402LBK-L/R



AR-4601FORK
AR-4606FORK



AR-46402FORK



AR-5000FORK



AR-4606CBL



AR-4601CBL

Item #	Description	M.S.R.P
AR-4601BK-L	Loop Brake & Cable for 4601,	\$25
AR-4601BK-R	Loop Brake & Cable for 4601, 4606	\$25
AR-3000LBK-L	Handle & Loop Brake ASM with Cable for 3 Wheeler, Left	\$29
AR-3000LBK-R	Handle & Loop Brake ASM with Cable for 3 Wheeler, Right	\$29
AR-4606LBK-L	11" Handle & Loop Brake ASM with Cable for 4606, Left	\$29
AR-4606LBK-R	11" Handle & Loop Brake ASM with Cable for 4606, Right	\$29
AR-46401LBK-L	Etched Handle & Loop Brake ASM with Cable for 46401, 4608, Left	\$34
AR-46401LBK-R	Etched Handle & Loop Brake ASM with Cable for 46401, 4608, Right	\$34

Item #	Description	M.S.R.P
AR-46402LBK-L	16" Handle & Loop Brake ASM with Cable for 46402, Left	\$34
AR-46402LBK-R	16" Handle & Loop Brake ASM with Cable for 46402, Right	\$34
AR-5000LBK-L	10" Handle & Loop Brake ASM with Cable, Stopper for AR-5000, Left	\$38
AR-5000LBK-R	10" Handle & Loop Brake ASM with Cable, Stopper for AR-5000, Right	\$38
AR-4601FORK	Fork for Standard Rollator	\$25
AR-4606FORK	Fork for Standard Rollator	\$25
AR-46402FORK	Fork for Wide Rollator	\$30
AR-5000FORK	Chrome Plated Fork for AR-5000	\$30
AR-4606CBL	Ball Head Cable 43" Long	\$15
AR-4601CBL	T-Shape Head Cable 51 1/4" Long	\$15

WALKING AIDS

Metro Travel Walker

- » Quickly and easily folds up for storage in small spaces
- » Innovative mechanism allows for easy touch variation
- » Dual size pockets included
- » Weight: 6.5lbs
- » Weight capacity: 250lbs
- » Height adjustments: 32-36" for users 4'10" - 6'8"
- » Wheels: 4" Diameter
- » Colors: Black, Walnut, Rose & Amber



Item #	Description	M.S.R.P
ST-4100	Metro Travel Walker	\$149.99
ST-4101	Replacement Wheels (pair)	\$19.99
ST-4102	Ski-Glides (pair)	\$11.99
ST-4103	Pouches (left & right)	\$19.99

Hemi-Walker

- » Designed for patients with use of only one hand
- » Folds for storage
- » Height adjustments: 29.5" - 34.5"



Item #	Description	M.S.R.P	Sugg. HCPCS
A-WA6005HEM	Hemi-walker	\$85	E0135

Two-Button Folding Walker with Wheels

- » Anodized aluminium frame with steel cross braces
- » Two button release mechanism
- » Height adjusts in 1" increments
- » 5" wheel
- » 4 sets/cs
- » 250 lbs. weight capacity
- » Width inside hand grip: 17.5"



Item #	Description	M.S.R.P	Sugg. HCPCS
A-WA6106WIC-4	Folding walker w/wheels	\$126/ea	E0143

Two-Button Folding Walker

- » Anodized aluminium frame with steel cross braces
- » Two button release mechanism
- » Height adjusts in 1" increments
- » 250 lbs. weight capacity
- » Width inside hand grip: 17.5"



Item #	Description	Pkg.	M.S.R.P	Sugg. HCPCS
A-WA6106-1	Folding walker	1/cs.	\$95	E0135

Youth Walker, Two-Button, Folding, with Wheels

- » Anodized aluminium frame with steel cross braces
- » Two button release mechanism
- » Designed for users 4'6" - 5'4" in height
- » 220 lbs. weight capacity
- » Width inside hand grip: 18"



Item #	Description	Pkg.	M.S.R.P	Sugg. HCPCS
A-WA6107W-2	Youth folding walker	2/cs.	\$95	E0143

Heavy Duty Walker with Wheels

- » Oversized frame
- » Sturdy 1" diameter aluminium tubing
- » 2 button release mechanism
- » 2 sets/cs
- » 475 lbs. weight capacity
- » Width inside hand grip: 21"



Item #	Description	M.S.R.P	Sugg. HCPCS
A-WA4500W-2	Heavy duty walker w/wheels	\$199/ea	E0149

Bariatric Walker with Wheels

- » Anodized 1" aluminium frame with dual reinforced steel cross brace
- » Two button release mechanism
- » Real wheeled roller guide provides effortless sliding
- » 700 lbs. weight capacity
- » Width inside hand grip: 27"



Item #	Description	M.S.R.P	Sugg. HCPCS
A-W500BW	Bariatric walker w/wheels	\$269	E0149

Folding Paddle Walker with Wheels

- » Design for patients with manual dexterity limitations
- » Height adjustment: 32.5"-39.5"
- » Approx. user height: 5'5"~6'2"
- » Weight capacity: 250 lbs.
- » Pkg: 4/cs



Item #	Description
A-W6106WPD4	Folding Paddle Walker with Wheels

Universal Walker Tray

- » Easily slides onto standard walkers
- » Holds meals and reading materials
- » 2 recessed cup holders
- » Size: 21"x16"x1"
- » Weight Capacity: 5 lbs



Item #	Description
A-51010830300	Walker Tray

Walker Platform Attachment

- » Mounts on the side of walker for people who bear weight across their forearms
- » Grip handle can be adjusted side-to-side
- » Attaches to most walkers
- » 2 sets/cs
- » HCPCS: E0154



Item #	Description	M.S.R.P
A-WPA6401-2	Walker Platform Attachment	\$108 ea

Walker Glide Attachment

- » Universal size fits most walkers
- » High density plastic
- » Pkg: 1 pair



Item #	Description	M.S.R.P
A-3010	Glide Attachments	\$19

Stand Assist Walker

- » Helps seated users gradually progress from the lower level of handles to the top level and stand more easily
- » Height adjustments: 32"-39" / 22"-29"
- » Approx. user height: 5'5"~6'2"
- » Weight capacity: 300 lbs.



Item #	Description
A-WA6116U-4	Stand assist walker

Walker Basket

- » Attaches to the front of walkers
- » 2 sets/cs
- » HCPCS: E1399



Item #	Description	M.S.R.P
A-WABASK-2	Walker Basket	\$29 /ea

Universal Walker Pouch

- » Attaches to most walkers and wheelchairs
- » Machine washable
- » HCPCS: E1399



Item #	Description	M.S.R.P
A-WA6106BAG	Walker Pouch	\$29 /ea

Walker Balls

- » Designed to glide smoothly
- » Precut & ready to use
- » Color: Grey or Red
- » Pkg.: 1 pair/Box



Item #	Description	M.S.R.P
A-WA0300GREY	Grey, 1 pair	\$9.50
A-WA0300RED	Red, 1 pair	\$9.50

WALKING AIDS

Adjustable Folding Cane

- » Can fit into purse, suitcase, etc.
- » Height adjustment: 33"-37"
- » Weight capacity: 250 lbs



Item #	Description	M.S.R.P
A-CA2010BK	Folding Cane	\$22

Straight Cane

- » Anodized aluminium shafts
- » Height adjusts in 1" increments



Item #	Height Range	Wt. Limit	M.S.R.P
A-CA2000BK-6	31"-40"	250 lbs	\$19
A-CA2000GR-6	31"-40"	250 lbs	\$19
A-CA4000GR	31"-40"	420 lbs	\$39

Quad Canes

- » Small base: 6" x 8"
- » Large base: 7 1/2" x 12"
- » Approx. user height: 4'10" - 6'4"
- » Anodized aluminium shafts with reinforced steel base
- » Sugg. HCPCS: E0105



Item #	Height Range	Unit Weight	Weight Limit	M.S.R.P.
A-QC4011SB-4	29" ~ 38"	2.2 lbs	250 lbs	\$38
A-QC4011LB-4	29" ~ 38"	2.2 lbs	250 lbs	\$42
A-QC4500HD	29" ~ 38"	3 lbs	450 lbs	\$75

Walker Extension Leg and Casters

- » Taller users can extend the height of their walker
- » Quick installation; No tools required
- » Fits most 1" tubing



Item #	Description	Pkg	M.S.R.P
A-115	Extension legs	2/set	\$36
A-115W	Extension legs w/5" caster	2/set	\$56

Crutches & Forearm Crutches

- » Lightweight anodized aluminum
- » Height adjusts in 1" increments
- » Weight limit: 250 lbs
- » 2 pcs/cs
- » Sugg. HCPCS: E0110
- » Bariatric crutches available in youth, adult, and tall sizes; 500 lbs weight limit



Item #	Approx. User Height	Height Range	M.S.R.P.
A-CR3745-Y	4'6"~5'2"	37" ~ 45"	\$47
A-CR4452-A	5'1"~5'9"	44" ~ 52"	\$47
A-CR5260-T	5'10"~6'6"	52" ~ 60"	\$49
A-FC2332-Y	4'2"~5'2"	23" ~ 32"	\$67
A-FC2938-A	5'1"~5'9"	29" ~ 38"	\$67
A-FC3241-T	5'10"~6'6"	32" ~ 41"	\$69

5" Walker Wheels w/ Glide Cap Kits

- » Height adjustable
- » Fits 1" inside diameter tubing
- » Includes: 2 non-swivel 5" nylon wheels and 2 plastic glide caps
- » HCPCS: E0155
- » M.S.R.P.: \$18



Item #	Description	M.S.R.P
A-005W	5" Walker wheels w/guide cap kits	\$18

Walker Replacement Tips

- » 100% Natural rubber tips
- » Fits 1 1/8" diameter aluminium tubings

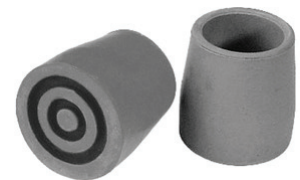

Item #	Description
A-TIP004-2	2/bag
A-TIP004-4	4/bag

Replacement Tips for Canes

» Fits quad cane base



Item #	Description
A-TIP002L	For large quad cane, 2/bag
A-TIP002S	For small quad cane, 2/bag

Crutch Accessory



A-N0222



A-N0223

Item #	Description
A-N0222	Foam Arm Pad; 1 pair
A-N0223	Foam Hand Grip; 1 pair

Knee Walker

- » Provides a comfortable and pain free alternative to crutches
- » Ideal for users who are recovering from foot surgery
- » Weight Limit: 300 lbs.
- » Net Weight with Basket: 23.6 lbs.
- » Sugg. HCPC: E0118



AKN401BK



AKN402BK

Item #	# of pads	Pad size	Overall L x W	Handle Height	M.S.R.P
AKN401BK	1	14" x 6"	31" x 14.5"	20.75"	\$545
AKN402BK	2	6" x 6", 2pcs.	31" x 14.5"	20.75"	\$545

Replacement Tips for Quad Canes

- » Fits most canes
- » Size: 1.75"(h) x 0.7"(d)
- » Base: 1.5"



Item #	Description
A-TIP001-2	Tips for quad canes; 2/bag

Walker Accessories/Parts

		
AKN401SEAT	AKN402SEAT	AKN4AXLE
		
AKN4BKT	AKN4BRK	AKN4HBKC
		
AKN4SPST	AKN4SRL	AKN4SSCR
		
AKN4WHL8	AKN4HGRP	

Item #	Description	Size
AKN401SEAT	Seat for AKN401BK Knee Walker	14" x 6"
AKN402SEAT	Seat for AKN402BK Knee Walker	6" x 6"
AKN4AXLE	Wheel Axle	N/A
AKN4WHL8 & AKN4AXLE	Wheel (8") and Axle	8" x 1½"
AKN4BKT	Basket	N/A
AKN4BRK	Brake System	N/A
AKN4HBKC	Hand Brake & Cable	N/A
AKN4HGRP	Hand Grip	N/A
AKN4SPST	Steering Post	N/A
AKN4SRL	Release Level	N/A
AKN4SSCR	Star Screw	N/A

PATIENT MONITORS

Handheld Pulse Oximeter - DI700M

- » Handheld design, compact, light for carrying and handling
- » Bright, easy-to-read LED numbers
- » Advanced digital processing technology
- » Accurate measurement during low perfusion
- » Anti-movement, stable performance
- » Parameter: Digital SpO₂, Pulse rate, Pleth bar
- » Use with 4AA Alkaline batteries



Handheld Pulse Oximeter - DI800M

- » 2.4" color OLED display, 320 x 240 pixels
- » Automatic display rotation (gravity activated)
- » Visual & sound alarms
- » IPx1 Degree of protection
- » Large data storage and transfer to PC for reviewing or printing
- » Parameter: Digital SpO₂, Pulse rate, Pleth bar & SpO₂ waveform
- » Optional: Nellcor SpO₂, 3 lead ECG, infrared receiving adapter



ViewSine A6 Patient Monitor

- » Standard oximetry platform: Masimo Rainbow® SET Pulse CO-Oximetry SpO₂, PR, PI, Total hemoglobin (SpHb®)
- » Size: 16.6" x 14.25" x 8.39"
- » Weight: ≤ 19.8 lbs
- » Oxygen content (SpOC™), Carboxyhemoglobin (SpCO®), Methemoglobin (SpMet®), Pleth Variability Index (PVI®)
- » Option Oximetry: Nellcor SpO₂, BLT digital SpO₂
- » 14.1" anti-glare color TFT-LCD display
- » Dozen parameters with variety modules assembled on demand, easy upgrade, saves replacement costs.



ViewSine A8 Patient Monitor

- » Standard oximetry platform: Masimo Rainbow® SET Pulse CO-Oximetry SpO₂, PR, PI, Total hemoglobin (SpHb®)
- » Size: 17" x 15.3" x 8.1"
- » Weight: ≤ 24 lbs
- » Oxygen content (SpOC™), Carboxyhemoglobin (SpCO®), Methemoglobin (SpMet®), Pleth Variability Index (PVI®)
- » Optional oximetry: Nellcor SpO₂, BLT digital SpO₂
- » 17 anti-glare color TFT-LCD display
- » Dozen parameters with variety modules assembled on demand, easy upgrade, saves replacement costs



ViewSine M69 Patient Monitor

- » Standard configuration: ECG, HR, RESP, NIBP, SpO₂, RR, TEMP, Battery
- » 12.1" LCD display, high resolution
- » 7 lead ECG waveform display in the same screen
- » Digital SpO₂ technology offers anti-motion and anti-low perfusion functions
- » Drug dose calculation
- » OXYCRG software



ViewSine M9500 Patient Monitor

- » Standard configuration: ECG, HR, RESP, NIBP, SpO₂, 2-TEMP, Lithium Battery
- » Advanced platform for both software and hardware. Fully meets the clinical needs of standard vital signs, night acuity, and anesthesia monitoring.
- » 15" TFT LCD, high resolution (1024*768)
- » Dual alarm light - independent parameter alarm light and technical alarm light
- » Power-off storage (72 hour trend & 1 ECG waveform)

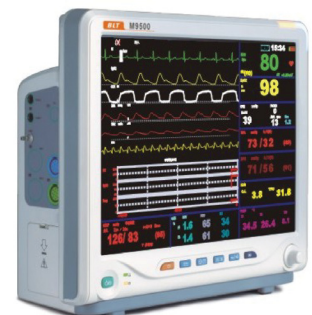

HOSPITAL BEDS & ACCESSORIES

Century 9900 Long Term Care Bed



BED9900

- » For use in institution or home
- » Provides security locks in position at any height other than its lowest position
- » Designed for safe, reliable and comfort operation
- » Hand control with single fault safety
- » Mains isolation system
- » Wooden single-deck head/foot board, easy to assemble and disassemble
- » Trapeze and IV holders
- » 8 Heavy duty castors
- » Bed Width: 35" (to 42" with extension kit)
- » Bed Length: 76" (to 84" with extension kit)
- » Trendelenburg: 0°-12°
- » Reverse Trendelenburg: 0°-12°
- » Weight capacity: 500 lbs
- » M.S.R.P.: \$4,295.00
- » Optional: Back up batteries, Nursing Control Panel

PVC Pipe & Fitting Inhabit Low Bed



PVC-BED680-40S

- » Healthcare Grade PVC Pipe and Fittings
- » 36" wide, 80" long
- » Inhibits/controls the growth of bacteria
- » Mattress not included

Century 9900P Long Term Care Bed



BED9900P

- » For use in institution or home
- » Provides security locks in position at any height other than its lowest position
- » Designed for safe, reliable and comfort operation
- » Hand control with single fault safety
- » Mains isolation system
- » Composite head/foot board, easy to assemble and disassemble
- » Trapeze and IV holders
- » 8 Heavy duty castors
- » Bed Width: 35" (to 42" with extension kit)
- » Bed Length: 76" (to 84" with extension kit)
- » Trendelenburg: 0°-12°
- » Reverse Trendelenburg: 0°-12°
- » Weight capacity: 500 lbs
- » M.S.R.P.: \$4,995.00
- » Optional: Back up batteries, Nursing Control Panel

Bed Side Cabinet

- » Made of ABS material
- » Light, steadiness, anti-aging, impellent
- » Large capacity drawer



Item #	Description	M.S.R.P
BED-CAB300BL	Blue	\$295

HOSPITAL BEDS & ACCESSORIES

Homecare Bed Lightweight BED2100

- » Semi-electric
- » Foot section weighs 50% less than conventional foot sections
- » Easy to use, two piece split frame design
- » The motor assembly can be easily installed and removed
- » 3" swivel locking casters provide stability
- » Quiet UL approved electronic system
- » Total bed weight (Bed & Motor) is 154 lbs
- » Bed height: min. 15", max. 24"
- » Overall bed size: 88"L. x 36"W.
- » Weight capacity: 400 lbs (includes patient weight, mattress weight and any accessories)



Item #	Sugg. HCPCS	M.S.R.P
BED2100	E0295, E0260-PKG	\$1,818

Homecare Bed BED3000

- » 36" full-electric
- » Welded angle steel construction
- » Easy to use, two piece split frame design
- » Reinforced corner plates
- » Reinforced head & foot springs
- » 3" swivel, locking casters provide stability
- » Quite UL approved electric system
- » Weight capacity: 400 lbs (includes patient weight, mattress weight and any accessories)



Item #	Sugg. HCPCS	M.S.R.P
BED3000	E0297, E0265-PKG	\$2,080

Homecare Bariatric Bed

- » Quiet, smooth operation
- » Heavy duty solid steel frame ensures strength and patient safety
- » Split pan design with removable bed ends for easy set up
- » Weight capacity includes patient weight, mattress weight and any accessories



Item #	Height	Dimensions	Surface	Weight Limit	Sugg. HCPCS	M.S.R.P
B-T4000	16" - 24.5"	42"(w)x88"(l)	42"(w)x80"(l)	600 lbs.	E0301, E0303-PKG	\$4,645
B-T5048	18.5" - 26"	48"(w)x88"(l)	48"(w)x80"(l)	750 lbs.	E0302, E0304-PKG	\$6,969
B-9007	18.5" - 26"	54"(w)x88"(l)	54"(w)x80"(l)	850 lbs.	E0302, E0304-PKG	\$8,169

HOSPITAL BEDS & ACCESSORIES

Homecare Low Bed BEDL3500

- » Bed height: min. 8.75" (with cap) max. 17.75" (with casters, floor-to-bed deck)
- » Dimensions: 35"W x 88"L
- » Sleep surface: 35"W x 80"L
- » Weight capacity: 400 lbs.
- » Quiet, smooth operation and all steel construction
- » Easy to use hand pendant



Item #	Sugg. HCPCS	M.S.R.P
BEDL3500	E0295, E0260-PKG	\$2,195

Bed Control Box



B-TC2

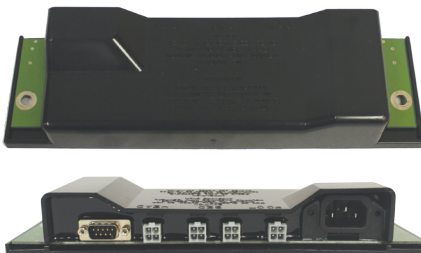

B510-JBOX

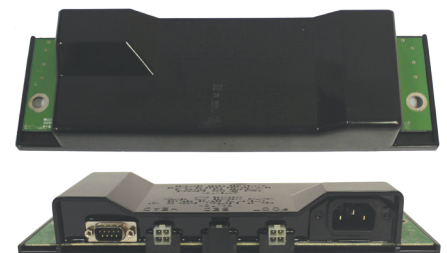

B210-JBOX

Item #	Description	Replace	Pkg.	M.S.R.P
B210-JBOX	Control box for bed. Two motor plugs are square, 4 pins	B2000, BED2100, B3000, B-T4000 Beds	1	\$299
B-TC2	Control box for bed. Motor plugs are 6 pins	Tuffcare 2 motor bed	1	\$299
B510-JBOX	Control box for bed (heavy duty). Four motor plugs are square	B-T5048	1	\$399

Bed Hand Controls



B210-PEND4



B310-PEND6



B310-PEND6C



B310-PEND6+TQ



BED21-PENDOKI



BED21-PENDWT



BED21-PEND6XY



B310-PEND6C-TQ

Item #	Description	Replace	Pkg.	M.S.R.P
B210-PEND4	Screw-on connector 4 function, 9 pin female	B2000F 2 motor bed	1	\$95
B310-PEND6	Screw-on connector 6 functions, 9 pin female	B3000F, B-T4000, B-9005, B-9006, B-9007	1	\$119
B310-PEND6C	Clamp-on connector 6 functions, 9 pin female	BEDL3200	1	\$119
BED21-PENDOKI	5 pin male round connector	Bed with Okin motor	1	\$99
BED21-PENDWT	5 pin male round connector	Bed with Dewert motor	1	\$99
BED21-PEND6XY	5 pin male round connector	Bed with Maruni motor	1	\$99
B310-PEND6+TQ	Screw-on connector 6 functions, 9 pin female	B3000F, B-T4000, B-9005, B-9006, B-9007	1	\$129
BED21-PEND6C-TQ	Clamp-on connector 6 functions, 9 pin female	B3000F, B-T4000, B-9005, B-9006, B-9007	1	\$129

HOSPITAL BEDS & ACCESSORIES

Bed Rail & Bed Side Stand Assist

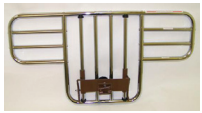

B-M100U



B-RAIL400M



B-M204P

Item #	Description	M.S.R.P	Sugg. HCPCS
B-M100U	Bed Rail, Half Size, Hammer-tone, Universal Clamp	\$140	E0305
B-M100P	Bed Rail, Half Size, with Cross Brace	\$140	E0305
B-RAIL400M	Bed Rail, Half Size For H.D. Bed	\$175	E0305
B-M204P	Bed Rail, Full Size, P.E. coated, 4 Bars	\$130	E0310
B-RAIL5048M	Bed Rail, Half Size for 48" Bed	\$225	E0310

Bed Side Stand Assist

- » Bed Side Stand Assist
- » Easy to install
- » Fits most beds
- » Size: 11"W x 11.5"L x 37"H
- » 2 sets/pkg
- » MSRP: \$97/ea



B-K400P-2

Adjustable Blanket Support

- » Easy to install
- » Fits most beds
- » Size: 6"W x 19"H x 20"D
- » MSRP: \$44/ea



D-5592028-00

Bed Side Rail

- » Easy to install
- » Fits most beds
- » Size: 21"W x 31"~38"H x 47"D
- » MSRP: \$84/ea
- » 2/case

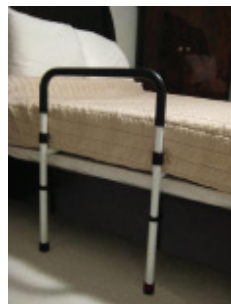

B-S406P-2

Home Style Bed Rail



B-P558-C0

- » Designed for use on standard home beds
- » Fits up to queen or king size
- » Raise or lower rails with the push of a button
- » For use in a long-term care environment or nursing home
- » Width adjustments: 26" to 72"
- » Product weight: 15 lbs.
- » MSRP: \$159

30" Safety Bed Rail - ST8050 Bed Rail Pivots Out of the Way

- » Width of Rail: 30"
- » Height of Rail: 23" from the base of the mattress
- » Gap Between Rails: 3"
- » Weight of Product: 12 lbs.
- » Weight Capacity: 400 lbs
- » Bed Type: Attaches to any home or hospital bed w/ included safety strap



EZ Adjust Bed Rail - ST8000 Extendable Bed Rail Pivots Away

- » Width: Locks in place at 26", 34", 42"
- » Height: 23" height from the base of the mattress
- » Gap between rails: 3"
- » Bed Type: Attaches to any home or hospital bed with included safety strap
- » Weight of Product: 14 lbs.
- » Weight Capacity: 400 lbs.



HOSPITAL BEDS & ACCESSORIES

Portal Bed Rail - ST5000 **Advantage Traveller**

- » Rail Height: 22"
- » Rail Width: 17"
- » Base Size: 21" x 17"
- » Weight of Product: 8 lbs.
- » Weight Capacity: 400 lbs.
- » Made for Bed Type:
Attaches to any home or hospital bed with included safety strap
- » MSRP: \$79.99



Bed Cane - ST2041 **A Bed Handle w/ Free Organizer Pouch**

- » Rail Height: Adjustable 19"-22"
- » Rail Width: 15"
- » Base Size: 23" x 19"
- » Weight of Product: 12 lbs.
- » Weight Capacity: 350 lbs.
- » Made for Bed Type: Attaches to any home or hospital bed with included safety strap
- » MSRP: \$99.99

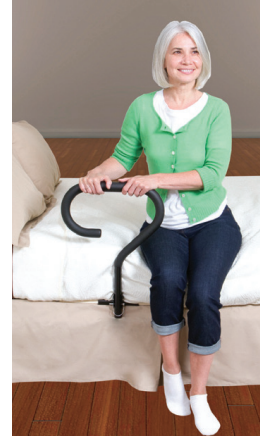

Econorail - ST5100 **Safety's Most Affordable Value**

- » Handle Height: 21.5"
- » Handle Width: 16" (base)
12" (top)
- » Base Size:
20" deep x 16" wide
- » Weight of Product:
1.5 lbs.
- » Weight Capacity: 300 lbs.
- » MSRP: \$69.99



Bed Caddie - ST2085 **Helping Hand to a Sitting Position**

- » Strap Length: Adjustable
48"-84"
- » Length between handles:
12"
- » Handle Grip: 5"
- » Product Weight: 2 lbs.
- » Weight Capacity: 300 lbs.
- » MSRP: \$24.99



Stable Rail - ST5800 **Bed Rail with Legs**

- » Height adjustment from floor to top of handle: 21"-44"
- » Height adjustment from mattress base to top of handle:
17.5"-22.5"
- » Height range from floor
to horizontal support
structure under mattress:
13.5"-21.5"
- » Weight capacity: 300 lbs.
- » MSRP: \$89.99



Mobility Bed Rail - ST5850 **Bed Rail with Legs & Swing out Arm**

- » Height adjustment from floor to top of handle: 21"-44"
- » Height adjustment from
mattress base to top of
handle: 17.5"-22.5"
- » Height adjustment from
floor to horizontal support
structure under mattress:
13.5"-21.5"
- » Depth of horizontal support
structure under mattress:
25"
- » Mobility Arm: Swings out 19"
away from bed
- » Weight Capacity: 300 lbs.
- » Weight of Product: 10.5 lbs
- » MSRP: \$119.99.



HOSPITAL BEDS & ACCESSORIES

Medical Bags & Supplies



BAGBED030-200



BAGWHL071-150



BAGCON369-250



BAGME101-500



BAGME105-500



BAGCOM3872-100

Item #	Description	Size	Pkg.
BAGBED030-200	Bed Bags	72" x 52," 1mil	200/Roll
BAGWHL071-150	Wheelchair Bags	30" x 20" x 35"	150/Roll
BAGCON369-250	Oxygen Concentrator Bags	22" x 12" x 26," 1.5mil	250/Roll
BAGME101-500	Small Equipment Bags	20" x 24"	500/Roll
BAGME105-500	Medium Equipment Bags	24" x 30"	500/Roll
BAGCOM3872-100	Commode Bags	27" x 12" x 38"	100/Roll
BAGMAT180-100	Mattress Bags	40" x 10" x 90," 2mil	100/Roll

Overlay Mattress Gel

- » Ideal Group 1 support surface
- » Fire Retardant
- » Low Sheer Nylon/Vinyl Cover



Item #	Dimensions	M.S.R.P.	Sugg. HCPCS
B-MATTGEL3671	70" x 34" x 3"	\$345	E0185
B-MATTGEL42	70" x 42" x 4"	\$595	E0185
B-MATTGEL48	70" x 48" x 4"	\$795	E0185
B-MATTGEL54	70" x 54" x 4"	\$895	E0185

Convolut Bed Pad

(Egg crate foam)

Item #	Description	M.S.R.P.
PM-6025	34" x 74" x 3"	\$39



Mattress

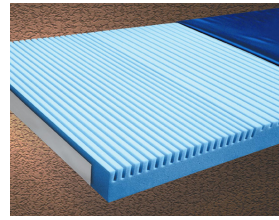

B-MATT-300SC-2

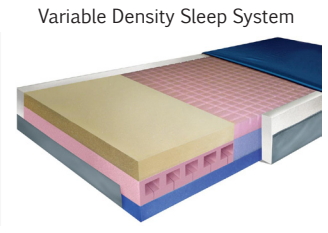

B-MATT6500-2RRF



B-MATT6500-DE-2-FB

Item #	Dimensions	Description	M.S.R.P.	Sugg. HCPCS
B-MATT-3680FB	80" x 36" x 6"	Polyester Fiber Core	\$275	E0271
B-MATT-3680INSP	80" x 36" x 7"	Inner Spring	\$275	E0271
B-MATT-3684	84" x 36" x 7"	Inner Spring	\$325	E0271
B-MATT-4280H	80" x 42" x 7"	Bariatric solid foam core	\$549	E0272
B-MATT-4284H	84" x 42" x 7"	Bariatric solid foam core	\$649	E0272
B-MATT-4880H	80" x 48" x 7"	CORE55 Bariatric Mattress	\$749	E0272
B-MATT-5480H	80" x 54" x 7"	CORE55 Bariatric Mattress	\$949	E0272
B-MATT-THERA	80" x 36" x 7"	Therapeutic Foam Mattress	\$450	E0272
B-MATT-THERA-84	84" x 36" x 7"	Therapeutic Foam Mattress	\$500	E0184
B-MATT6500-2RRF	80" x 36" x 6"	Multi-Layered, Multi-zoned, Foam w/ laterals	\$595	E0184
B-MATT-300SC-2	80" x 36" x 6"	Multi-Zoned foam, w/Stretch cover	\$450	E0271
B-MATT6500-DE-2-FB *	36" x 80" x 6"	Dynamic Elite Mattress with Visco Gel Technology	\$795	N/A

*Add -RR for optional raised side rails

Mattress Protectors

Zippered Vinyl Mattress Cover



Item #	Description	Unit	M.S.R.P.
B-MATTCOVER-12	36" x 80" x 7"	12 pc/cs	\$9 each
B-MATTCOV42-1	42" x 80" x 7"	1 each	\$17 each

HOSPITAL BEDS & ACCESSORIES

Hospital Bed Motors



Hi-Lo Motor

Head Motor

Foot Motor

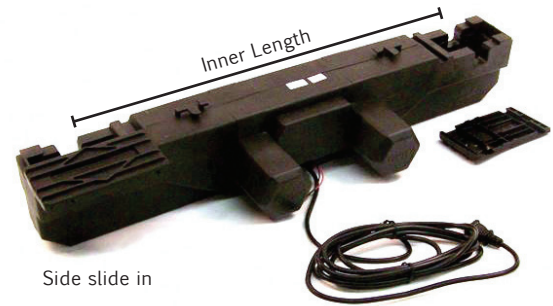

Side slide in

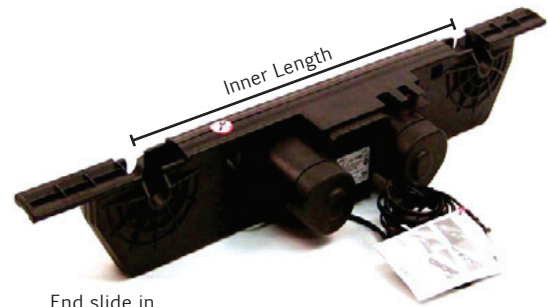

End slide in

Item #	Description	Replace	M.S.R.P
B210-MOTF	Foot motor	B2000, B3000	\$209
B210-MOTH	Head motor	B2000, B3000	\$209
B310-MOT3	Hi-Lo motor	B2000, B3000	\$209
B320-MOTM	Hi-Lo motor	BEDL3200	\$209
B410-MOTF	Foot motor	B-T4000	\$349
B410-MOTH	Head motor	B-T4000	\$349
B410-MOT	Hi-Lo motor	B-T4000	\$349
B510-MOT	Hi-Lo motor	B-T5048	\$399
B510-MOTF	Foot motor	B-T5048	\$399
B510-MOTH	Head motor	B-T5048	\$399

Item #	Description	Inner Length	Total Length	Mounting Bar Diameter	Replace	M.S.R.P
BED21-MOT21	Okin motor, 3¼"x5½" Lid - Side slide in	21½"	27¾"	1"	BED2100	\$395
BED21-MOT22	Dewert motor, 2¼"x5½" Lid - End slide in	21½"	29¾"	1"	BEDL2200	\$395
BED21-MOT23	Maruni motor, 2¼"x4¼" Lid - End slide in	21½"	28½"	1"	BED2100BMZJ	\$365

Hospital Bed Replacement Parts



BED21-MOT23COV



BED21-MOT22COV



BED21-MOTRCOV



B410-ACTWIRE



B310-JBCORD



BED-MOTLATSCW

Item #	Description	Replace	M.S.R.P
BED21-MOT23COV	Okin motor lid, 3¼"x5½" Lid - Side slide in	Okin Motor	\$12
BED21-MOT22COV	Dewert motor lid, 2¼"x5½" Lid - End slide in	Dewert Motor	\$12
BED21-MOTRCOV	Maruni motor, 2¼"x4¼" Lid - End slide in	Maruni Motor	\$12
B410-ACTWIRE	Actuator Shift Wire F9X2100L	T4000	\$29
B310-JBCORD	Power Cord for Hospital Bed J-Box	B2000, B3000, B2100, B-T4000	\$32
BED-MOTLATSCW	Holding Screw for Bed Motor	B2000, B3000	\$9

HOSPITAL BEDS & ACCESSORIES

Bed Panel Replacement



B210-T4012P-Plastic
B210-T4013F-Wood Grain



B210-T4012H-Wood Grain
B210-T4HBP-Plastic



B410-T4012H



B410-T4012P
B410-T4013F

Item #	Description	M.S.R.P
B210-T4012H	Wood grain for Head board 35½"x15¼"	\$27
B210-T4013F	Wood grain for Foot board 35½"x13"	\$25
B210-T4012P	Plastic panel for Head/Foot board 35½"x13"	\$27
B210-T4HBP	Plastic panel for Head board 35½"x15¼"	\$29

Item #	Description	M.S.R.P
B410-T4012H	Wood grain for Head board 42"x15¼"	\$39
B410-T4012P	Plastic panel for Head/Foot board 42"x13"	\$29
B410-T4013F	Wood grain for Foot board 42"x13"	\$34



Plastic Panel



Wood Grain

Bed Edgecover

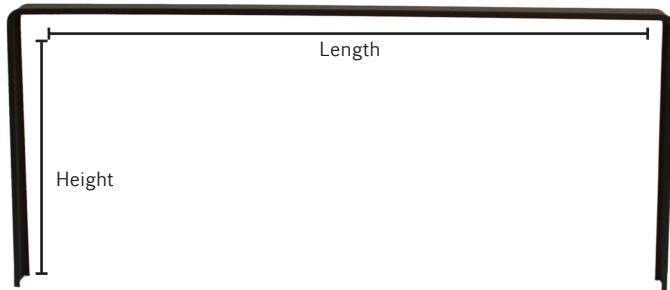

Item #	Description	M.S.R.P
B210-HBEDGECOVER	For head board: 35½"x15¼"	\$25
BED21-BEDGECOVER	For head/foot board: 35½"x13¼"	\$22
B410-EC013	For foot/head board: 41¾"x13"	\$34

Item #	Description	M.S.R.P
B410-EC015	For foot/head board: 41¾"x15¼"	\$37
B510-T5012H	For foot/head board: 47¾"x13"	\$44
B-T9006-EC014	For foot/head board: 41¾"x17"	\$47

Head & Foot Section (Frame)

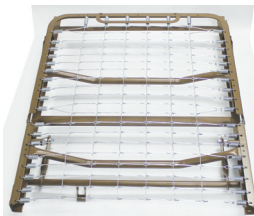

BED2100-FS



BED2100-HS



B3000HS

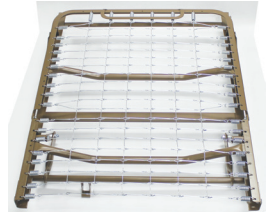

B3000FS

Item #	Description	M.S.R.P
BED2100-FS	Foot Section Frame, fits BED2100 Semi Electric Bed	\$389
BED2100-HS	Foot Section Frame, fits BED2100 (Semi), B3000 (Full Electric)	\$379
B3000HS	Head Section Frame, fits B3000 Full Electric	\$389
B3000FS	Foot Section Frame, fits B3000 Full Electric	\$384

HOSPITAL BEDS & ACCESSORIES

Head Board & Foot Board Assembly



Item #	Description	M.S.R.P
BED21-FBP	Foot Bedend assembly, fits BED2100	\$159
BED21-HBP	Head Bedend assembly with plastic panel, fits BED2100, B3000	\$159
B3000-FBP	Foot Bedend assembly with plastic panel, fits B3000	\$169
B410-FBP	Foot Bedend assembly with plastic panel, fits B-T4000	\$359
B410-HBP	Head Bedend assembly with plastic panel, fits B-T4000	\$349
BEDL3500-FBP	Foot Bedend assembly with plastic panel, fits BEDL3500	\$199
BEDL3500-HBP	Head Bedend assembly with plastic panel, fits BEDL3500	\$199

Side Rail Bumper Pad

- » Prevents injuries due to patients striking against side rails
- » Easy install/take down
- » 14" x 72" x 1.5"

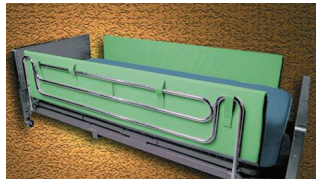

Item #	Description	M.S.R.P
B-RAILPAD72	Side Rail Bumper Pad	\$111

Bed Wedges (Cloth Cover)

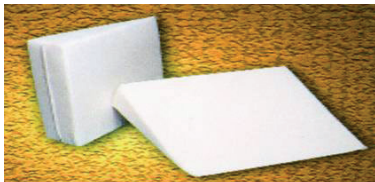

Item #	Description	M.S.R.P	Sugg. HCPCS
BW-3825	26" x 24" x 7.5"	\$54	E0199
BW-3826	26" x 24" x 10"	\$63	E0199
BW-3827	26" x 24" x 12"	\$72	E0199

Safety Floor Mats

- » Provides peace of mind if bed rails are not an option
- » 2" High Density Foam
- » 24" x 66" x 2"



Item #	Description	M.S.R.P
B-FLORMAT	Safety Floor Mat	\$162

Trapeze Bar

- » Chrome plated steel construction
- » Easy to install without tools
- » Adjustable height
- » Mounts easily to headboards



B-TP100
Limit: 250 lbs



B-TP6000
Limit: 600 lbs

Item #	Description	M.S.R.P	Sugg. HCPCS
B-TP100U	Upper Part	\$225	E0910
B-TP100B	Base	\$225	E0940
B-TP6000	Bariatric-Freestanding	\$2499	E0912

HOSPITAL BEDS & ACCESSORIES

Overbed Table



B-T3015C



B-T3036T



B-T3202

Item #	Description	Table Top	Height Adj.	Wt. Limit	Sugg. HCPCS	M.S.R.P
B-T3015C	Non-tilt	31.5"x15"	31"-43"	25 lbs	E0274	\$149
B-T3036T	Tilt	31.5"x15"	31"-43"	25 lbs	E0274	\$199
B-T3202	Tilt	35"x15"	31.5"-43"	25 lbs	E0274	\$212

Patient Lifts

Heavy Duty PL-650HD



- » Durable carbon steel frame
- » Heavy duty 6-point multi-tilt spreader bar
- » Includes battery charger
- » Optional DSC200 scale attachment available
- » Weight capacity: 600 lbs.

PL4000H-S



- » Durable carbon steel frame
- » 4-point lift cradle
- » Heavy duty hydraulic cylinder
- » 3" casters with brakes
- » Weight capacity: 400 lbs.

PL4200E-S



- » Low base height standard
- » Foot pedal base opening for ease of chair/commode access
- » Universal battery system with low charge and load capacity warning
- » Weight capacity: 400 lbs.

Stand Assist Lift



- » 40.1 Overall length
- » 4.5" Base height, 40" Mast height
- » Utilizes 2, 12V 4.5AH Battery
- » Includes battery charger
- » Weight capacity: 400 lbs.
- » 600 lbs. Bariatric Assist Lift also available

Item #	Width (Base closed) Int./Ext.	Width (Base open) Int./ Ext.	Spreader Bar Height Max / Min	Base Height	Mast Height	Overall Length	Weight Capacity	M.S.R.P.	Sugg. HCPCS
PL-650HD	21.5" / 26"	38" / 43"	71" / 22"	5"	48"	50"	600 lbs	\$4,995	E0635
PL4000H-S	21" / 26"	30.5" / 35.5"	66" / 21"	4.5"	46"	41"	400 lbs	\$1,595	E0630
PL4200E-S	21" / 26"	30.5" / 35.5"	64" / 23"	4.5"	46"	41"	400 lbs	\$2,995	E0635
PL-SAL1230	20.75" / 25.5"	32.5" / 37"	68" / 33"	4.5"	40"	40"	400 lbs	\$3,945	N/A

HOSPITAL BEDS & ACCESSORIES

Sling

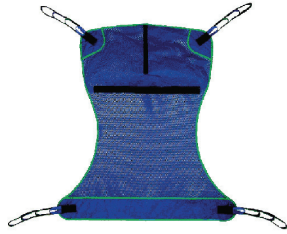

PL-S110 (M)
PL-S111 (L)



PL-S114 (M)
PL-S115 (L)



Universal Sling
PLS100M (M)
PL-S883 (L)

Item #	Material	Size	Opening	Full Body	Weight Limit	M.S.R.P.	Sugg. HCPCS
PL-S110	MESH	M	NO	YES	400 lbs	\$140	E0621
PL-S111	MESH	L	NO	YES	400 lbs	\$140	E0621
PL-S112	SOLID	M	NO	YES	400 lbs	\$150	E0621
PL-S113	SOLID	L	NO	YES	400 lbs	\$150	E0621
PL-S114	MESH	M	YES	YES	400 lbs	\$140	E0621
PL-S115	MESH	L	YES	YES	400 lbs	\$140	E0621
PL-S117	SOLID	XL	NO	YES	450 lbs	\$190	E0621
PL-S140	MESH	XXL	NO	YES	600 lbs	\$190	E0621
PL-S141	MESH	XXL	YES	YES	600 lbs	\$190	E0621
PL-DSLGU6	PADDED	L	NO	YES	600 lbs	\$250	E0621
PLS100M	MESH	M	NO	NO	400 lbs	\$140	E0621
PL-S883	MESH	L	NO	NO	400 lbs	\$140	E0621

I.V. Post

- » Gives patients on intravenous fluids
- » Adjustable height: 47"~85"

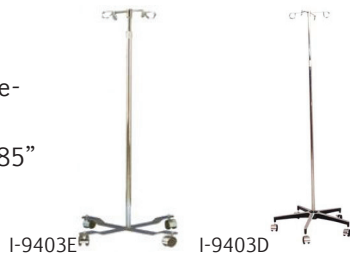

Item #	Description	Sugg. HCPCS	M.S.R.P.
I-9403E	I.V. Pole with 4 prong base	E0776	\$49
I-9403D	Deluxe I.V. Pole with 5 prong base	E0776	\$65

PL-DSC200 Scale

- » For use with patient lift
- » Calibrated from 0~600 lbs.
- » MSRP: \$1,295



Bed Transporter

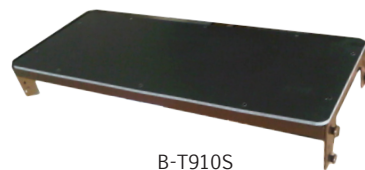

B-T910S



- » Allows for the easy transportation and storage of homecare beds
- » M.S.R.P. \$199

HOSPITAL BEDS & ACCESSORIES

Casters, Gear Case & Adapters



Item #	Description	Fit	M.S.R.P
B210-T40181	Double Nylon Caster with Brake for Bed	B2000/B3000/BED2100/BEDL2200	\$29
B210-T40191	Double Nylon Caster without Brake	B2000/B3000/BED2100/BEDL2200	\$29
B200-T40191	Single Caster 3" without Brake	B2000/B3000/BED2100/BEDL2200	\$29
B410-CST-1	4 7/8" Caster with 3/8" Stem without Brake, Large Stem	B-T4000/B-T5048	\$49
B410-CST	4 7/8" Caster with 3/8" Stem without Brake, Small Stem, Old Style	B-T4000/B-T5048	\$49
B410-CSTWBK-1	4 7/8" Caster with 7/8" stem with Brake	B-T4000/B-T5048	\$49
BED-PLUG	Caster Holder with 3/8" hole	B2000/B3000/BED2100/BEDL2200	\$12
BED-PLUG-2	Caster Holder with 7/8" hole	B2000/B3000/BED2100/BEDL2200	\$12
B210-T408	Gear Case, T-Shape for Head Board	BED2100	\$49
B210-T409	Gear Case, T-Shape with Handle for Foot Board	BED2100	\$59
B310-T409	Gear Case, T-Shape with Handle for Foot Board, Full Bed	B3000	\$59
BED21-T409	Gear case, with handle for Foot Board, Semi-Bed	BED2100	\$59
B220-T409	Gear case, with handle for Foot Board, Low-Bed	BEDL2200	\$59
B410-T308	Drive Shaft	B-T4000	\$79
B210-T308	Drive Shaft	BED2100/B3000	\$59

MATTRESS & SUPPORT SURFACES

XCell Air Mattress 1000

- » Low pressure therapy pump and mattress system
- » Pressure range: Fixed at 100 mmHg
- » Air output: 4.5 liters (115V)
- » Two air outputs

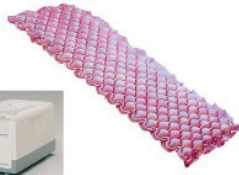

Item #	Dimensions	M.S.R.P.	Sugg. HCPCS
PM-XCELL1000	92" x 34" x 2½"	\$135	E0181
PM-APP2000-P	92" x 35" x 2½" PAD only	\$45	N/A

Low Air Loss System 5"

- » Smart fuzzy-logic Dynamic Low Pressure
- » Suitable for stage II bed sore treatment
- » High performance, high volume output, and multi-function features
- » Weight Capacity: 250 lbs.



Item #	Dimensions	M.S.R.P.	Sugg. HCPCS
PM-XCELL5000V	80" x 35" x 5"	\$1,395	E0372

Alternating Mattress Replacement System

- » Low pressure therapy pump and mattress system
- » Designed for long term care or home care
- » One of the most convenient systems for the treatment and prevention of pressure ulcers
- » Straightforward installation, simplified operation and pressure relief performance
- » Suitable for stage II bed sore treatment
- » Weight capacity: 250 lbs.



Item #	Dimensions	M.S.R.P.	Sugg. HCPCS
PM-XCELL8000V	80" x 35" x 8"	\$1,995	E0277

XCell Air Mattress 2000

- » Adjustable low pressure therapy pump and mattress system
- » Power: 115V / 60 HZ
- » Pressure range: 55~105 mmHg
- » Air output: 4.5 liter (115V)

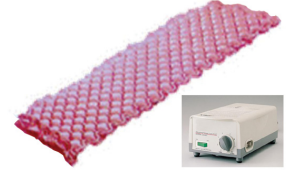

Item #	Dimensions	M.S.R.P.	Sugg. HCPCS
PM-XCELL2000	118" x 34" x 2½"	\$145	E0181

Low Air Loss System 8"

- » Smart fuzzy-logic Dynamic Low Pressure
- » Suitable for stage II & III bed sore treatment
- » High performance, high volume output, and multi-functional features
- » Weight Capacity: 300 lbs.



Item #	Dimensions	M.S.R.P.	Sugg. HCPCS
PM8080	80" x 35" x 8"	\$2,395	E0277
PM8080-84	84" x 35" x 8"	\$2,695	E0277

Bariatric Air Mattress System with Low Air Loss

- » The Neopro Series is an advanced alternating pressure mattress system suitable for bariatric patients
- » Smart sensor technology with easily recognized graphical control panel
- » 10" bladders with cell-in-cell design that offers sufficient weight support during a power failure
- » Weight capacity: PM-NEOPRO-42 (700 lbs), PM-NEOPRO-48 (900 lbs)



Item #	Dimensions	M.S.R.P.	Sugg. HCPCS
PM-NEOPRO-42	80" x 41" x 10"	\$4,295	E0277
PM-NEOPRO-48	80" x 47" x 10"	\$4,995	E0277

MATTRESS & SUPPORT SURFACES

ROHO® SOFFLEX 2 MATTRESS OVERLAY SYSTEM

- » **SKIN PROTECTION:** Protecting an individual's skin/soft tissue is critical for prevention and treatment of pressure ulcers. The ROHO SOFFLEX 2 Mattress Overlay System is a non-powered, adjustable, and reactive support surface for individuals who require skin/soft tissue protection or have other therapeutic needs. The SOFFLEX 2 provides individualized pressure, shear, and friction management through force redistribution to an individual's shape.
- » **COST EFFECTIVE:** The SOFFLEX 2 is a cost effective option for different care settings, costing less than high-quality powered mattress systems. It can also be easily cleaned and disinfected for reuse. **ADJUSTABLE:** Flexible, interconnected air cells can be adjusted to match the body's contour, providing personalized therapy and critical skin/soft tissue protection. The SOFFLEX 2 is made of three sections that snap together. Simply add or release air in each mattress overlay section to accommodate the individual's needs.
- » **NON-POWERED:** Eliminates concern about power failure or energy consumption costs.
- » **EASE OF USE:** The SOFFLEX 2 is lightweight, easy to transport, easy to adjust and set up on different bed types
- » Size: 36" x 81.75" x 3.5," Weight Limit: 330 lbs., Sugg. HCPCS: E0371



PMR-SOFFLEX2

True Low Air Loss System - SelectAir®

- » SelectAir System includes: SelectAir Pump, Mattress with foot pillow, zippered "Nylon" cover with foot pillow and a one-inch foam pad
- » System weight capacity: 400 lbs.
- » "True" Low Air Loss Technology
- » The SelectAir® System quietly circulates air through 16 individual cells and allows air to escape from the mattress



Item #	Dimensions	M.S.R.P.	Sugg. HCPCS
PMR-SASTADSYS	78" x 35"	\$6,100	E0277

ROHO® Dry Floatation Bariatric Kit

- » Works in conjunction with a standard size ROHO DRY FLOATATION Mattress Overlay to widen the mattress for use with bariatric bed frames.
- » Add-on sections allow the bariatric patient the therapeutic benefits of the ROHO DRY FLOATATION technology.



Item #	Dimensions	Sugg. HCPCS
PMR-MATTYSCKIT	Standard: 39" & 48"	E0371

ROHO® Dry Floatation Mattress Overlay

- » Cost effective technology allows a client with any stage ischemic (pressure) ulcer and/or myocutaneous flap to benefit from a custom-adjusted environment
- » Helps heal advanced stage (III & IV) ischemic ulcers
- » Four zoned sections
- » No external power source required
- » Lightweight: 8lbs per section or 32lbs for a complete system



Item #	Dimensions	M.S.R.P.	Sugg. HCPCS
PMR-MATTYSYC	4 zoned 20"x34"	\$10,125	E0371

Air Mattress Accessories

- » Air Mattress Blower
- » Master tool for air mattress inflation
- » Reduce inflation time by 90%



Item #	Description	M.S.R.P.
PM-BLOW	Blower for APM	\$189
PM-BLOW-ADPII	Two Outlet Adaptor	\$12

MATTRESS & SUPPORT SURFACES

Fall Prevention Cover with Rails

- » Mattress enclosure cover designed to fit most alternating pressure or inner spring/foam mattress
- » Provides real patient safety and protection
- » Reduce the risk of falling
- » Easy to clean



Item #	Description	M.S.R.P.
PM-PROTECTYOU2	Fall preventing cover with rail	\$299

Fusion 2K™ Therapy Mattress

- » For more challenging wounds, the 1K Dynamic Dispersion™ sections can be removed and replaced with a *SelectAir®* True Low Air Loss insert.
- » Then, when combined with a blower based pump the mattress is now a fully functioning, “hospital grade”, true low air loss mattress.
- » The FUSION 2K™ pump offers iSense Processing to continually monitor the patient’s immersion, as well as, Pulsation (alternating pressure) and System Lock.
- » The 1K/2K combination is the best of both worlds of therapy.
- » Available as a full unit (shown) or as a conversion kit, which includes the pump and full low air loss section.
- » 300 lbs. weight limit
- » 5 year warranty
- » 80” x 36” x 6” or 84” x 36” x 6”

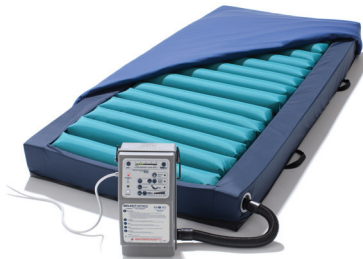

Item #	Description	M.S.R.P.	Sugg. HCPCS
PMR-FUS2K80	80” Full FUSION 2K™ Low Air Loss Mattress	\$5,999	E0277
PMR-FUS2K84	84” Full FUSION 2K™ Low Air Loss Mattress	\$5,999	E0277
PMR-FUSKCONV	FUSION 2K™ Conversion Kit includes Pump and LAL insert	\$5,499	E0277

Fusion 1K™ Therapy Mattress

- » Centered around Dynamic Dispersion™ technology, where each air and foam filled baffle communicates to create exceptional envelopment and pressure redistribution.
- » Each zone is sealed in order for air to be the primary support within each zone.
- » The quilted cover is waterproof, breathable, fire retardant and antimicrobial.
- » Also comes with a firm edged perimeter and soft heel section.
- » FUSION 1K™ creates an environment for prevention and therapy.
- » 500 lbs. weight limit
- » 5 year warranty
- » 80” x 36” x 6” or 84” x 36” x 6”



Item #	Description	M.S.R.P.	Sugg. HCPCS
PMR-FUS1K80	80” FUSION 1K™ Mattress	\$1,399	E0373
PMR-FUS1K84	84” FUSION 1K™ Mattress	\$1,450	E0373

Fusion XC™ Therapy Mattress

- » For the budget minded facility, the FUSION XC™ is an inexpensive choice for non-powered therapy.
- » The XC comes with a waterproof, breathable, fire retardant, and antimicrobial cover.
- » Also comes standard with a firm edged perimeter and a soft, sloped heel.
- » 500 lbs. weight limit
- » 5 year warranty
- » 80” x 36” x 6” or 84” x 36” x 6”

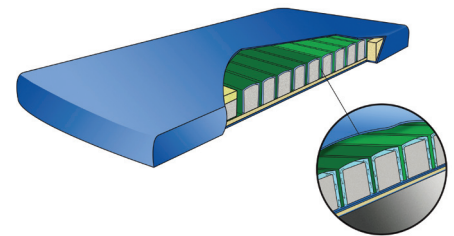

Item #	Description	M.S.R.P.	Sugg. HCPCS
PMR-FUSXC80	80” FUSION XC™ closed system, not convertible	\$1,099	E0373
PMR-FUSXC84	84” FUSION XC™ closed system, not convertible	\$1,199	E0373

DIABETIC SUPPLIES/RISK MANAGEMENT

GlucoFirst Monitor & Test Strips

- » Biosensor technology
- » 0.7 microliter blood sample
- » 6 second test time
- » No coding required
- » 250 memory



Item #	Description	Units	Sugg. HCPCS	M.S.R.P
DI2010E0607	Starter Kit	EA	E0607	\$88
DI2A4235	Test Strips	50/ Box	A4253	\$47
DI2A4256	Control Solution	EA	A4256	\$24
D-NDC983202-0001	Lancet - 30G	100/Box	A4259	\$14
D-LAND	Lancing Device Universal	EA	A4258	\$24
DI2010USB	USB Cable	EA	N/A	\$19

Toe Correctors

- » Soft cotton blend for comfort
- » Aligns hammertoes, crooked and overlapping toes



Item #	Description	Pkg
D-7655119-002	Felt Toe Corrector	2/pk

Multiple Toe Separator

- » Reduces pressure & friction between toes
- » Provides comfortable toe separation



Item #	Description
D-7655108-002	Multiple Toe Separator

Foot Protector

- » Breathable, convoluted foam construction
- » Foot strap included
- » Sold by the pair



DFP2135

Diabetic Socks



Item #	Description	M.S.R.P
DSOC-M1013	Men's size 10~13 (3 pairs in a bond)	\$9/each pair.
DSOC-L0911	Lady's size 9~11 (3 pairs in a bond)	\$9/each pair
DSOC-C0608	Children's size 6~8 (3 pairs in a bond)	\$9/each pair

Inserts

HCPCS K6028



DS-INS-(5P~14P)



3-Layer Support System
Thin layers fit comfortably in most shoes
1 pair / pk

DS-INS-(4.0-14.0)



3-Layer Marasonic Inserts
Heat moldable

Dalton Diabetic Shoes

Leather Shoes



Midnight Black



HCPCS: A5500

Accufit All Sports Shoes

- » Firm heel counters and raised sidewalls offer superior stability.
- » Firm, high toe box with soft linings help protect the foot.
- » 3 removable insoles for maximum protection and fitting flexibility.
- » High-tech, durable outsoles absorb shock forces and provide good cushioning.
- » Equipped with Silver-Max for anti-microbial, anti-odor and thermodynamic functions.



ASW



ASB



ALB

HCPCS: A5500



MSB



DLB



HLB

DIABETIC SUPPLIES/RISK MANAGEMENT

Care-Steps Risk Management

- » Double tread
- » Sizes up to 3X-Large
- » Terry side out
- » Superior coefficient of friction
- » 48pr/Case



Item #	Size	Color
80189	Child/Small Adult	Red
80190	Adult Medium	Red
80191	Adult Large	Red
80192	Adult X-Large	Red
80193	Adult 2X-Large	Red
80194	Adult 3X-Large	Red
80179	Child/Small Adult	Yellow
80180	Adult Medium	Yellow
80181	Adult Large	Yellow
80182	Adult X-Large	Yellow
80183	Adult 2X-Large	Yellow
80184	Adult 3X-Large	Yellow
80172	Adult X-Large	Orange

Care-Steps Risk Management

- » Single Tread
- » Sizes up to 4X-Large
- » Smooth side out
- » Latex free
- » 48pr/Case



Item #	Size	Color
80101	Infant	White
80112	Toddler	Peach
80102	Child/Adult Small	Moss Green
80103	Adult Medium	Blue
80104	Adult Large	Beige
80106	Adult X-Large	Grey
80108	Adult 2X-Large	Moss Green
80118	Adult 3X-Large	Heather Grey
80120	Adult 4X-Large	Heather Grey

Safe-Steps Fall Risk Management Kit

- » Stickers
- » Bracelets
- » Magnets
- » Patient safety footwear
- » X-Large
- » 48pr/Case



Item #	Description	Color
911R	Fall Risk Management Complete Kit	Red
911Y	Fall Risk Management Complete Kit	Yellow
911G	Fall Risk Management Complete Kit	Green

Eco-Steps - Single Tread

- » Single tread
- » Lightweight construction
- » Smooth side out
- » Made from 70% recycled content
- » 48pr/Case



Item #	Size	Color
E0102	Child/Adult Small	Sienna
E0103	Adult Medium	Redwood
E0104	Adult Large	Hickory
E0106	Adult X-Large	Spruce
E0108	Adult 2X-Large	Pine

Guardian Lymphedema Protective Garment

- » Moderate compression
- » Machine washable
- » 6pr/Case



Item #	Size	Color
59001-1B	Small	Beige
59001-2B	Medium	Beige
59001-3B	Large	Beige
59001-1D	Small	Dark Beige
59001-2D	Medium	Dark Beige
59001-3D	Large	Dark Beige

DIABETIC SUPPLIES/RISK MANAGEMENT

Care-Steps II & III - Hard Sole

- » Care-Steps II
- » Low cut
- » Multiple colors
- » Terry side out upper
- » 60pr/ Case
- » Care-Steps III
- » Ankle cut
- » Adult sizes
- » Terry side out upper
- » 60pr/ Case



CS II	CS III	Size	Color
80210		Toddler 4-5	White
80211		Toddler 6-7	White
80201		Child 8-10	Yellow
80202		Child 11-13	Yellow
80203		Youth 1-3	Yellow
80204	80304	Adult 5-6	Beige
80205	80305	Adult 6-7	Beige
80207	80306	Adult 7-8	Beige
80208	80308	Adult 9-10	Beige
80209	80309	Adult 11-12	Beige
80213		Adult 13	Beige

CareNett Dressing Retainers

- » Advanced memory yarns
- » Multiple sizes
- » Two-way stretch

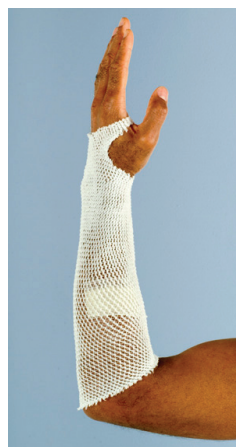

Item #	Size	Color
CN01	1	Natural
CN02	2	Natural
CN03	3	Natural
CN04	4	Natural
CN05	5	Natural
CN06	6	Natural
CN07	7	Natural
CN08	8	Natural
CN09	9	Natural
CN10	10	Natural
CN11	11	Natural
CN12	12	Natural
CN22	22 (Stretches to 80")	Natural

Guardian Light Compression Arm Protective Garment

- » Helps improve blood flow
- » Relieves aches and pains
- » Protects skin
- » 12pr/Case



Item #	Arm Circum.	Weight	Size	Color
39001B	Less than 10"	< 100 lbs	Small	Light Beige
39002B	10" to 12"	100 to 135 lbs	Medium	Light Beige
39003B	12" to 14"	135 to 180 lbs	Large	Light Beige
39004B	14" to 18"	> 185 lbs	X-Large	Light Beige
39001W	Less than 10"	< 100 lbs	Small	White
39002W	10" to 12"	100 to 135 lbs	Medium	White
39003W	12" to 14"	135 to 180 lbs	Large	White
39004W	14" to 18"	> 185 lbs	X-Large	White
39001D	Less than 10"	< 100 lbs	Small	Dark Beige
39002D	10" to 12"	100 to 135 lbs	Medium	Dark Beige
39003D	12" to 14"	135 to 180 lbs	Large	Dark Beige
39004D	14" to 18"	> 185 lbs	X-Large	Dark Beige

X-Span Dressing Retainers

- » Superior resilience
- » Two-way stretch
- » Color-coded sizing band



Item #	Size	Color
821	1	Gold
822	2	Olive
823	3	Mint
824	4	Aqua
825	5	Dark Purple
826	6	Light Purple
827	7	Maroon
828	8	Grey
830	9/10	Orange

Guardian Leg Protective Garment

- » One size fits most
- » Available in 2 colors
- » Protects skin
- » Machine washable
- » 12 pr/Case



Item #	Size	Color
W59318	Universal	White
B59318	Universal	Beige

Presto Breathable Brief

- » Soft cloth-like material is breathable and comfortable
- » Contoured core with super absorbent polymer
- » Convenient & refastenable tabs
- » Blue acquisition layer
- » Gentle outer leg gathers

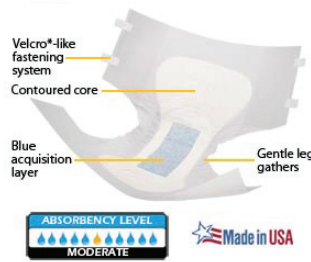

Item #	Size	Color	Pkg.
ABB11020	M (32"-44")	White	90 ct.
ABB11040	L (45" - 58")	Blue	72 ct.
ABB11050	XL (58"-66")	Beige	60 ct.

Presto Comfort Poly Brief

- » Poly outer cover
- » Blue acquisition layer
- » Contoured core
- » Gentle outer leg gathers
- » Adhesive tape tabs

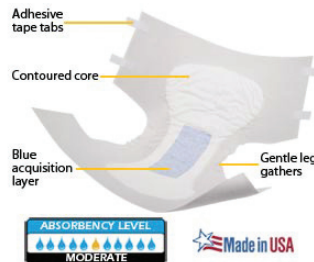

Item #	Size	Color	Pkg.
ABP10020	M (32"-44")	White	96 ct.
ABP10040	L (45"-58")	Blue	72 ct.
ABP10050	XL (58"-66")	Beige	60 ct.

Protective Underwear

- » Fits just like regular underwear
- » Cloth-like outer material
- » Premium acquisition distribution layer
- » Comfort-stretch waist
- » Special balanced core
- » Inner and outer leg barriers



Item #	Size	Color	Pkg.
AUB23020	M (32"-44")	White	80 ct.
AUB23040	L (44"-58")	White	72 ct.
AUB23050	XL (58"-68")	White	56 ct.
AUB23060	XXL (68"-80")	White	48 ct.

Presto Plus Breathable Brief

- » Soft cloth-like material is breathable and comfortable
- » Convenient and refastenable tabs
- » Extra absorbent contoured core
- » Premium acquisition distribution layer
- » Gentle leg gathers

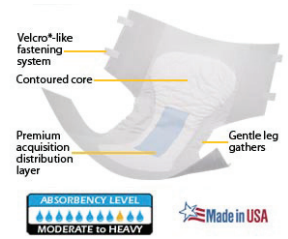

Item #	Size	Color	Pkg.
ABB21060	XXL (63"-69")	Lt. Green	48 ct.
ABB41070	XXXL (78"-95")	Beige	32 ct.

Presto Light Protective Underwear

- » Pulls on and off like regular underwear
- » Incredible softness and comfort
- » Outstanding absorbency and odor protection
- » Tear-away side panels for quick and easy removal
- » Special balanced core
- » Color-coded waistband indicated on back of underwear



Item #	Size	Color	Pkg.
AUB12020	M (32"-44")	White	80 ct.
AUB12040	L (44"-58")	White	72 ct.
AUB12050	XL (58"-68")	White	56 ct.

Presto Supreme Protective Underwear

- » Flexible stretch panel for a discrete fit.
- » Cloth-like outer material for incredible softness and comfort.
- » Premium acquisition distribution layer quickly and efficiently draws moisture away from skin.
- » Special balanced core for outstanding absorbency and odor protection.
- » Tear-away side panels for quick, easy removal.
- » Color-coded waistband indicates back of underwear.

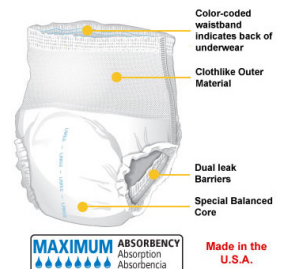

Item #	Size	Color	Pkg.
AUB34020	M (32"-44")	White	80 ct.
AUB34040	L (45"-58")	White	72 ct.
AUB34050	XL (58"-68")	White	56 ct.

INCONTINENCE

Liners / Boosters

- » Quilted design increases the capacity of any undergarment
- » Barrier free for breathability and flow control
- » Self-adhesive strip for secure placement
- » Super-absorbent core locks in wetness and reduces odor

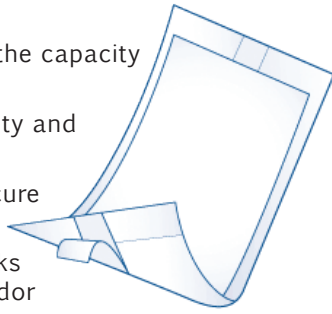

Item #	Description	Pkg.
ALB19500	Contoured Ultra Booster (13" x 24")	72 ct.
ALB19244	Natural Liner (4" x 12")	200 ct.

Protective Underpads - Disposable

- » Outstanding protection for beds
- » Non-woven topsheet
- » Latex free



Item #	Size	Color	Pkg.	Absorbency
UPP19020	23"x36"	Blue	150 ct.	Light
AUP12045	23"x36"	Blue	120 ct.	Light
UPP19030	30"x30"	Blue	150 ct.	Light
UPP29020	23"x36"	Green	150 ct.	Moderate
UPP39030	30"x30"	Pink	100 ct.	Heavy

Adult Wipe

- » Soft and comfortable
- » Latex free and alcohol free
- » 7.9"x12"
- » 48 count per package



Item #	Description	Pkg.
AWP100	Unscented Wipes	12 pkg/cs
AWP200	Scented Wipes	12 pkg/cs

Bladder Control Pads

- » Form fitting design
- » Elastic leg gathers
- » Soft, moisture-proof back
- » Self-adhesive tape
- » Super-absorbent core to lock in wetness & reduce odor

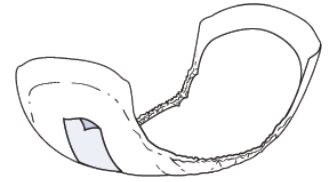

Item #	Description	Pkg.
APCI43120	Bladder Control Pads 4"x9.5" Regular	80 ct.
APCI43140	Bladder Control Pads 4"x11" Plus	76 ct.

Reusable Underpads

- » Highest quality fabric 50/50 Poly/Cotton Twill
- » Washable, dependable multi-layer protection for bedding
- » Durable and cost-effective
- » Available in a variety of sizes

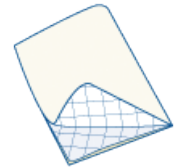

Item #	Size	Pkg.
APCI34017	17"x24"	27 ct.
APCI34024	24"x34"	36 ct.
APCI34030	30"x36"	24 ct.
APCI34034	34"x36"	24 ct.
APCI34054	34"x54"	12 ct.
APCI34072	34"x72"	12 ct.

Dalton DryAid Protective Underwear

- » Cloth-like stretch panels
- » Contoured to your body for an easy and comfortable fit
- » Super-absorbent Gel Core to prevent odor
- » Barrier leg cuffs offer the highest protection against leaks
- » Tear-away sides allow for easy removal
- » Colored stitching indicates front



Item #	Size	Color	Pkg.
AUW31020	M (30"-42")	White	80 ct.
AUW31040	L (40" - 54")	White	72 ct.
AUW31050	XL (48"-64")	White	56 ct.

ORTHOTIC DEVICES

Superior Fracture Walker Brace

- » Comfortable soft foam
- » Adjustable hook and loop closure
- » Designed to immobilize foot and ankle
- » Cold and shock resistant nylon foot guard
- » Sugg. HCPCS: L4386



Item #	Length	Size
ORT4386-14S	14"	S
ORT4386-14M	14"	M
ORT4386-14L	14"	L
ORT4386-17M	17"	M
ORT4386-17L	17"	L

Superior Fracture Walker Boot with Air Pouch & ROM

- » Comfortable soft foam
- » Air pouch inside boot for extra comfort
- » Adjustable hook and loop closure
- » Designed to immobilize foot and ankle
- » Adjustable ROM stop setting
- » Cold and shock resistant nylon foot guard
- » Sugg. HCPCS: L4360



Item #	Length	Size
ORT4360ROM-14S	14"	S
ORT4360ROM-14M	14"	M
ORT4360ROM-14L	14"	L
ORT4366ROM-17M	17"	M
ORT4366ROM-19L	19"	L

Superior Fracture Walker Brace with Air Pouch

- » Comfortable soft foam
- » Air pouch inside boot for extra comfort
- » Adjustable hook and loop closure
- » Designed to immobilize foot and ankle
- » Cold & shock resistant nylon foot guard
- » Sugg. HCPCS: L4360



Item #	Length	Size
ORT4360AP-14S	14"	S
ORT4360AP-14M	14"	M
ORT4360AP-14L	14"	L
ORT4360AP-17M	17"	M
ORT4360AP-17L	17"	L

Superior Ligament Brace

- » Soft foam lining with hook and loop closure
- » Polycentric hinge with extension and flexion stop setting
Extension stops: 0°, 10°, 20°, 30°, 40°
Flexion stops: 45°, 60°, 75°, 90°
- » Available for left or right leg
- » Sugg. HCPCS: L1845



Item #	Size
ORT1845M12001L	M, Left
ORT1845M12001R	M, Right
ORT1845M12002L	L, Left
ORT1845M12002R	L, Right

Wrist/Palm Supports

- » Aluminium stay for palm
- » Adjustable straps with Velcro closure
- » Suitable for both left and right hands
- » Sugg. HCPCS: L3908



Item #	Size
ORT3908-9023S	Small
ORT3908-9023M	Medium
ORT3908-9023L	Large

ORTHOTIC DEVICES

Knee Brace - Wrap-On Knee Wrap

- » The upright adjustable hinge knee brace allows effective flexion or extension settings needed for the given treatment needs
- » Sugg. HCPCS: L1832

Item #	Size	Knee Circumference
ORT-RK100-S	S	30 cm- 34 cm
ORT-RK100-M	M	34 cm- 38 cm
ORT-RK100-L	L	38 cm- 42 cm
ORT-RK100-XL	XL	42 cm- 46 cm



Knee Brace - Front Wrap-On Knee Wrap Comfort Fit Elastic

- » Allows for effective flexion and extension settings needed for given treatment
- » Comes with a very comfortable high-tech flat knitting
- » Sugg. HCPCS: L1832



ORT-RK150

Knee Brace: Soft Knee Wraps

- » Soft lightweight neoprene knee wrap provides compression and can accommodate the EB wraps



ORT-SOFTKNE

Knee Brace: Rigid Wrap-on Knee Brace

- » Allows for effectively setting flexion or extension settings needed for the given treatment
- » Slip or wrap on rigid type of brace
- » Quick release snaps



ORT-RK200

Slip-On Knee Brace

- » The upright adjustable hinge knee brace allows for effective flexion or extension settings needed for the given treatment
- » Sugg. HCPCS: L1832



ORT-RK100PLUS

Knee Brace - Slip-On Knee Brace with Comfort Fit Elastic

- » A slip-on type of brace made of high-tech comfort fit elastic
- » Sugg. HCPCS: L1832



ORT-RK150PLUS

Lumbar Spinal Bracing System

- » LSO Spinal Bracing System provides circumferential compression, stabilizing the spine and promoting the healing process following post-operative back surgery.
- » Indicated for chronic back pain, stenosis spondylosis, and degenerative disk disease
- » Sugg. HCPCS: L0631



Item #	Size	Circumference around Navel
ORT-SB100-S	S	25"-30"
ORT-SB100-M	M	30"-35"
ORT-SB100-L	L	35"-40"
ORT-SB100-XL	XL	40"-45"
ORT-SB100-2XL	2XL	45"-50"
ORT-SB100-3XL	3XL	50"-55"

T/Pump® Professional

- » The T/PumpR Professional System provides safe and effective localized warming and cooling therapy with precise temperature control. It is effective for chronic pain relief and patient comfort in orthopedic conditions such as acute pain, muscle strain and spasm, skin trauma such as bruises, contusions and burns, chronic arthritis, tendonitis, neuritis, phlebitis, I.V. infiltration, infection, and localized pain.
- » Size: 8" w x 11.5" h x 8" d
- » Weight: 6.7 lbs empty
- » Flow Rate: 9 gph flow rate minimum
- » 4 temperature selections: 50°F, 95°F, 100°F or 107°F
- » Lock-out switch
- » Timed temperature therapy cycle-20 mins, 30 mins or continuous therapy
- » Uses tap water (and ice cubes if cooling)



TP700

The Arctic Ice System

- » The AIS delivers localized cold therapy to patients.
- » The AIS provides 4 to 5 hours of continuous cold therapy.



Item #	Description
PT-TPU	Universal Therapy Pad
PT-TPSNG-SM	Standard Single Therapy Boot
PT-TPDBL-SM	Standard. Double Therapy Boot
PT-TPSNG-LG	Large Single Therapy Boot
PT-TPDBL-LG	Large Double Therapy Boot
PT-TP1324	Large Back Pad (13"x24")
PT-TPMITT	Therapy Mitt
PT-VJW	Versatile Joint Wrap
PT-TPKN	Knee Therapy Pad

Aqua Relief System

- » New Hospital Grade System For Use In The Home
- » The Aqua Relief System delivers pain relief to achy feet and other body parts due to arthritic pain, carpal tunnel syndrome, back pain, and many other pain conditions.
- » Hospital-grade plug
- » Lo and Hi heat settings
- » 60 min. timer, plus auto shut off
- » Anti-inference device



TP-ARS-TPUMP

JSTIM - Joint Stimulation Arthritis Therapy System

- » The JStim is a patent-pending breakthrough in the treatment of osteoarthritis and rheumatoid arthritis. It is FDA and Medicare cleared, and through combinational therapy, it deploys the use of advanced electrotherapy and true compression therapy.
- » The JStim is an advanced electrotherapy device that works in tandem with soft, multi-layer conductive fabric and safe infrared heat to deliver therapy. These combined modalities are compressed against the treatment site using compression wraps, allowing the silver garment electrodes and infrared heat band to emit therapy directly into the target joint.

» Facts about JStim

The JStim is a drug alternative, noninvasive treatment intended for the reduction of pain and symptoms of osteoarthritis on the knee and rheumatoid arthritis on the hand.

Due to the unique combination of electrotherapy, compression and infrared heat conduction, the system may provide both pain relief and therapeutic results to the affected area. The JStim may provide a viable alternative to the use of pain medication. ***clinical studies yet to be performed**



- » Warnings: Patients who are pregnant or nursing should not use the device and it should only be used under the continued supervision of a physician. A physician's order is required to obtain the device.

Item #	Description
JSTIM1000	JSTIM Main Unit

PAIN MANAGEMENT

3-Strap Knee System (Electrode)

» Utilizes a high-quality knee compression wrap, and specific conductive silver fabric patches that connect to the JStim stimulation unit.

- » Medicare coded
- » HCPCS: E0762



Item #	Description	M.S.R.P.
JSTIM1000KN	3-Strap Knee System	\$995

JSTIM Hand System

» Consists of silver garment fabric in the shape of a glove along with a special compression glove to be fitted over the conductive components in order to block the outside current and to give effective treatments to the affected hand.

- » Medicare coded
- » HCPCS: E0762

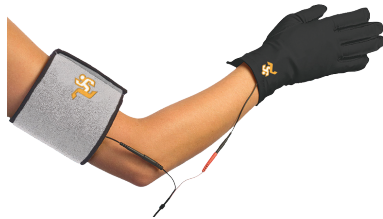

Item #	Description	M.S.R.P.
JSTIM1000H	JSTIM Hand System	\$995

The Ultima 3T TENS

- » Dual-channel device with three modes of operation (B, N, and M)
- » Pulse width and pulse frequency are adjustable
- » Equipped with a 30, 60, 90 minute timer
- » Comes with a protective cover
- » Sugg. HCPCS: E0730

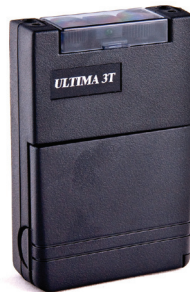

TENS-U3T

The Ultima 5 TENS

- » Dual-channel five-mode device with two wave form adjustments and a large LCD screen



TENS-U5T

Lymphedema Pump System

- » Fully variable pressure range from 30~80 mm Hg
- » Lock button to prevent tampering
- » Adjustable pause time
- » Bilateral application when needed
- » Four fully overlapping compression cells
- » Color coding to eliminate error
- » LP-701-A, Sugg. HCPCS: E0651

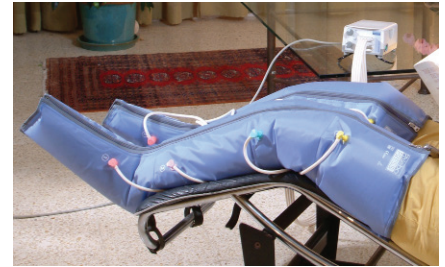

LP-701-A

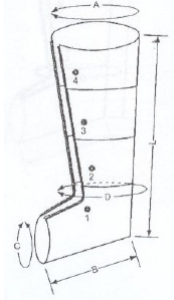

Item #	Description	Sleeve Dimension (cm)					M.S.R.P.	Sugg. HCPCS	
		A	B	C	D	L			
LP-701-A	Lymphedema Pump	N/A					\$995	E0651	
LP-LEG	Full Leg Sleeve	S+	66	30	32	40	75	\$495	E0667
		M	70	30	32	40	85		
		M+	74	38	32	40	95		
		L	80	41	47	55	65		
		L+	90	40	47	55	75		
XL	94	40	47	55	95				
LP-ARM	Full Arm Sleeve	M	56	--	29	90	--	\$495	E0668

The Ultima 11 TENS

- » Dual-channel eleven-mode TENS unit with three-wave form adjustments
- » Large LCD screen
- » Portable



The TENS 7500

- » A full featured digital five-mode device
- » Adjustable pulse width, pulse rate, and treatment timer
- » Large liquid display



The Ultima 20 TENS

- » Twenty-mode device with dual channels and three-wave forms
- » The unit produces a gentle stimulation through pads normally placed over the area of pain.
- » This stimulus helps the body produce natural pain relievers called endorphins.



Stimulation Devices

- » The True-Sine Interferential (IF) stimulator device is a battery operated device that includes two controllable output channels. Amplitude, mode and duration of the electrical impulses can be altered with the buttons and knobs.



Dual Point Probe Electrode

- » Stimulates acupuncture or pain points with this handheld remote dual-point stimulation probe.
- » Base of the handle accepts the positive and negative lead wire pins from your stimulator.
- » Carbon rubber tips at the end of flexible stems offer safe and easy point stimulation.
- » Works best with conductive gel or wet felt-tip pads applied to the carbon rubber tips.



The TENS/EMS Combo

- » Combines the benefits of both TENS therapy and EMS therapy through the use of digital controls. It has a timer feature that can record not only how many times the unit has been used for treatment but also the cumulative time the EMS unit has been used for treatment



TECOMBO

Conductive Copper Metal Ear Clip Electrodes

- » Conductive copper metal ear clip electrodes for stimulating acupuncture points on the ear lobe or for CES application. Plastic base handles of the clip accepts 2mm male pin from your lead wire. Apply self-adhesive felt tip pads to the inside surface of the ear clips, then wet the felt tips with water or conductive gel. Has just enough tension for it to clip to the base of the ear lobe with a comfortable fit.
- » 25 felt tip pads included.



Soft Touch Electrodes

- » A self-adhesive reusable disposable electrode with a pig tail pin connector
- » Available with a carbon and a blue cloth backing

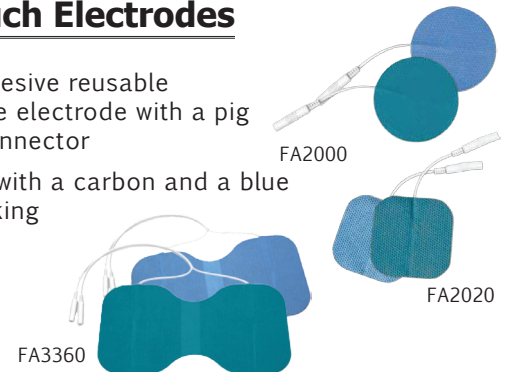

Item #	Description
TENS-FA2020	2" SQUARE (4-PACK)
TENS-FA2000	2" ROUND (4-PACK)
TENS-FA3360	BUTTERFLY (1-PACK)

PAIN MANAGEMENT

Lotion & Spray



Item #	Description
TENS-MS7170	PRE TENS GEL
TENS-MS71130	ALOE VERA LOTION 12 OZ.

Electrotherapy Garments

- » Now electrotherapy can be easily applied to hard to reach spots on the body with incredible accuracy. This unique conductive mesh material can stimulate large or multiple areas of the body.
- » The Electrotherapy Brace design works in conjunction with a wide variety of Electro-Medical devices.
- » The Electrotherapy Brace/Garments comes in a variety of sizes.



Item #	Description	Size
TENS-EBD410	Double Pad (vertical strip with 2 pigtails)	4"x10"
TENS-EBW440	EB Wrap (stretchy belt)	4"x40"
TENS-EBW840	EB Wrap	8"x40"
TENS-EGlove	Glove	One Size
TENS-ESock	Sock	One Size

EB Electric Back

- » Can include many different options of EB conductive patches



Item #	Description
TENS-EB1-410	Electric Back with 1 4"x10" Dual Electrode
TENS-EB2-410	Electric Back with 2 4"x10" Dual Electrode

Electric Vest

- » The Electric Vest is a one-size-fits-all thoracic vest that allows the users to Velcro in a variety of garment electrode pad options, enabling treatment to the lower back, mid-back, and upper back with ultimate coverage.



Item #	Description
TENS-EV1-410	Electric Vest with 1 4"x10" Dual Electrode
TENS-EV2-410	Electric Vest with 2 4"x10" Dual Electrode

Electric Knee

- » Comfortable, and includes a 3"x5" ground electrode garment patch for the thigh, and a 3"x5" active electrode garment patch to cover the knee



Item #	Description
TENS-EBKNEE	EB Electric Knee
TENS-EKD47	Electric Knee with 1 4"x7" Dual Electrode

Medical Grade Ultrasound/TENS Combo

- » The Ultrasound Combo combines electrical therapy with ultrasound therapy in one device.
- » FDA approved
- » 14 TENS programs with 1 MHz ultrasound
- » LCD backlight indication
- » Portable and professional
- » Sugg. HCPCS code: E0730



PM 2000 Portable Ultrasound Machine

- » This hand-held portable ultrasound device provides therapeutic heat.
- » Ultrasound penetrates far beneath the skin to soothe and comfort chronic or acute pain.



BIOFREEZE Pain Relieving Gel

- » Increases blood flow and warming of the area of pain at the cellular level



Item #	Size
TENS-BUSAT04-BUL	4 OZ. TUBE
TENS-BUSAP16-024	16 OZ. PUMP
TENS-BUSAP32-016	32 OZ. PUMP
TENS-BUSAPGA-004	128 OZ. PUMP
TENS-BUSASP-04	4 OZ. SPRAY
TENS-BUSASP-16	16 OZ. SPRAY
TENS-BUSAR03-BUL	3 OZ. ROLL-ON
TENS-BUSAWSU-048	24 WIPE BOX

High Performance Infrared Heat Therapy

- » This far infrared heat therapy system provides soothing relief from pain, muscle tension, and stress.
- » Q-Fiber wraps are fully portable through the car charger, USB adapter, wall charger, and even light-weight battery.
- » Speedy recovery
- » Relieves pain
- » Improves circulation
- » Relaxes muscles



Item #	Description
TENS-QFiberWW	Infrared Heat Therapy, wrist
TENS-QFiberBW	Infrared Heat Therapy, back

Infrared Light Wand

- » This hand-held infrared light wand provides therapeutic massage and deep relief.
- » Infrared heat penetrates far below the surface of the skin to soothe and comfort the nerves.



Theratrac Pneumatic Cervical Traction Unit

- » Indicated for use for the treatment and relief of cervical musculoskeletal or neurologic impairment
- » The Theratrac gently stretches neck muscles, allowing the vertebral discs to realign, and freeing the nerve root tissue from the pressure of the discs. The theratrac helps “locked” neck muscles to slowly stretch and relax, allowing misaligned vertebrae to resume their normal supportive position.
- » Clinical grade, designed for the home
- » Innovative and effective design
- » One size fits all (with the inclusion of three sizing insert pieces)



PAIN MANAGEMENT

Theratrak Lumbar Traction Brace

- » The Theratrak is an easy to use, highly functional and very effective lumbar traction device, giving the user the ability to treat their condition in the comfort of their own homes.
- » Theratrak utilizes pneumatic bladder technology, giving it the unique ability to administer a moderate lumbar decompression stretch to gently contour the innate spinal path.



Neck Support Posture Pump Cervical Spine Trainer

- » Inflatable cervical traction unit used to treat vertebrae symptoms, disease, and discomfort
- » Portable and convenient for use when traveling
- » Suggested HCPCS code: E0855



CVT1000



CVT2000

Dr. Archy Foot Massager

- » Provides a natural low-impact exercising motion that supports, stretches, and massages your arches



Dr. Necky Neck Massager

- » Dr. Necky is a wonderful little tool that will work your neck into relief like a professional masseuse. The special rolling wheels have a knuckle, to loosen up those tight muscle knots.



Body Drummer Hot/Cold Vibrating Massager

- » A unique massager that not only provides a soothing vibrating massage, but also allows for either hot or cold treatment simultaneously
- » Handheld and rechargeable



POWER WHEELCHAIRS & RELATED PRODUCTS

ePower

- » Max Speed 4.3 Mph
- » Turn Radius 37"
- » Gnd. Clearance 4.8"
- » Controller VSI 50 Amp
- » Batteries U-1 12V 34AH x 2
- » Charger 5 Amp Offboard
- » Casters 8" Foam Filled Tires
- » Drive Wheels 12.5" Foam Filled Tires
- » Brakes Intelligent, Regenerative Electromagnetic Brakes
- » Weight Limit 300 lbs - 16", 18", 20"
- » Optional Elevating leg rests, oxygen tank holder



Item #	Seat Width	Seat Depth	Back Height	Wt w/o Front Rigging	Overall Width	M.S.R.P.	Sugg. HCPCS
PC1104A-16SF	16"	16"	16"-18"	83 lbs	22.5"	\$4,895	K0822
PC1104A-18SF	18"	16"	16"-18"	86 lbs	24.5"	\$4,895	K0822
PC1104A-20SF	20"	18"	16"-18"	92 lbs	26.5"	\$4,895	K0822

ePower Bariatric

- » Max Speed 4.6 Mph
- » Turn Radius 40"
- » Controller P&G 70 Amp
- » Batteries 22NF x2
- » Charger Offboard
- » Casters 8" Foam Filled Tires
- » Drive Wheels 12.5" Foam Filled Tires
- » Brakes Intelligent, Regenerative Electromagnetic Brakes and Auxiliary Hand Brakes
- » Optional Elevating leg rests, oxygen tank holder



Item #	Seat Width	Seat Depth	Back Height	Wt w/o Battery	Weight Limit	Overall Length	Overall Width	M.S.R.P.	Sugg. HCPCS
PC1422F	22"	18"	19"	104 lbs	450 lbs	45"	28"	\$7,495	K0824
PC1424F	24"	20"	19"	108 lbs	600 lbs	46"	30"	\$8,970	K0826
PC1426F	26"	20"	19"	112 lbs	700 lbs	48"	32"	\$9,600	K0828
PC1428F	28"	20"	19"	116 lbs	700 lbs	48"	34"	\$10,600	K0828

POWER WHEELCHAIRS & RELATED PRODUCTS

Primechair PC-MP3C-2

- » Max Speed 3.5 Mph
- » Turn Radius 27"
- » Gnd. Clearance 2"
- » Controller PG VR2 40A
- » Batteries 12V, 22AH x2
- » Charger 3 Amp Offboard
- » Casters 7" Foam Filled Tires
- » Drive Wheels 9" Foam Filled Tires
- » Brakes Intelligent, Regenerative Electromagnetic Brakes
- » Overall Width 23"
- » Overall Length 33"
- » Lightweight and easy to disassemble for handling, storage, and transportation
- » Optional: Oxygen tank



Item #	Seat Width	Back Width	Back Height	Wt. w/o Battery	Weight Capacity	M.S.R.P.	Sugg. HCPCS
PC-MP3C-2-AR / BL	17"	16"	16"	89.5 lbs	250 lbs	\$4,995	K0823

Primechair Mid-Wheel Drive PC-MP3CM

- » Max Speed 5 Mph
- » Turn Radius 19"
- » Gnd. Clearance 3"
- » Controller Dynamic Shark 2
- » Batteries U1 12V, 34AH x2
- » Charger 5 Amp Offboard
- » Casters 6" Foam Filled Tires
- » Drive Wheels 10" Foam Filled Tires
- » Brakes Intelligent, Regenerative Electromagnetic Brakes
- » Overall Width 24"
- » Overall Length 36.6"
- » Stylish and compact mid-wheel drive model with 10" solid drive wheels
- » Extremely low center of gravity offers a lower seat height and is designed smooth and stable handling
- » Sturdy, deluxe captain's seat with semi-reclining back
- » Optional elevating leg rests, oxygen tank holder, and rear basket



Item #	Seat Width	Seat Depth	Back Height	Weight (Seat+Base)	Weight Capacity	M.S.R.P.	Sugg. HCPCS
PC-MP3CM	18"	17"	19"	126 lbs	300 lbs	\$5,395	K0823
PC-MP3CM2-AR / BL	20"	18"	24.8"	126 lbs	300 lbs	\$5,495	K0823

POWER WHEELCHAIRS & RELATED PRODUCTS

Primechair Rear Wheel Drive PC-MP3C-1

- » Max Speed 4.3 Mph
- » Turn Radius 25"
- » Gnd. Clearance 3"
- » Controller P&G VSI 50 Amp
- » Batteries U1 12V 34AH x2
- » Charger 5 Amp Offboard
- » Gradient 12°
- » Casters 8" Foam Filled Tires
- » Drive Wheels 10" Foam Filled Tires
- » Brakes Intelligent, Regenerative Electromagnetic Brakes
- » Stylish and compact with 10" rear drive wheels and alloy rims
- » Extremely low center of gravity offers a lower seat height and is designed for smooth and stable handling
- » Sturdy, deluxe captain's seat with semi-reclining back and adjustable height, flip-up armrests
- » Optional elevating leg rests, oxygen tank holder and rear basket



Item #	Seat Width	Overall Width	Overall Length	Seat Depth	Back Height	Weight (Back+Seat)	Weight Capacity	M.S.R.P.	Sugg. HCPCS
PC-MP3C-1-AR	20"	24"	40"	18"	19"	130 lbs	300 lbs	\$5,495	K0823
PC-MP3C-1-BL	20"	24"	40"	18"	19"	130 lbs	300 lbs	\$5,495	K0823

Tacahe Mid-Wheel Drive PC1350

- » Max Speed 5 Mph
- » Turn Radius 22"
- » Gnd. Clearance 3"
- » Controller PG VR2
- » Batteries 22NF 55AH x 2
- » Charger 5 Amp Offboard
- » Casters 6" Foam Filled Tires
- » Drive Wheels 12" Foam Filled Tires
- » Brake Intelligent, Regenerative Electromagnetic Brakes
- » 350 lbs weight capacity
- » Mid-wheel drive design delivers outstanding maneuverability in tight spaces
- » High performance obstacle climb suspension
- » Low center of gravity design
- » Optional elevating leg rests, oxygen tank holder, and rear basket



Item #	Seat Width	Overall Width	Overall Length	Seat Depth	Back Height	Weight (Back+Seat)	Weight Capacity	M.S.R.P.	Sugg. HCPCS
PC1350-AR	21"	27"	42.5"	20"	27"	143 lbs	350 lbs	\$7,595	K0825
PC1350-BL	21"	27"	42.5"	20"	27"	143 lbs	350 lbs	\$7,595	K0825

POWER WHEELCHAIRS & RELATED PRODUCTS

Tacahe Mid-Wheel Drive Heavy Duty PC1451M

- » Max Speed 5 Mph
- » Turn Radius 21"
- » Controller Dynamic Shark 50
- » Batteries 12V, 22NF x 2
- » Charger 5 Amp Offboard
- » Gradient 8°
- » Casters 9" Foam Filled Tires
- » Drive Wheels 12" Pneumatic Tires
- » Brakes Intelligent, Regenerative Electromagnetic Brakes
- » Overall Width 27.2"
- » Overall Length 35.4"
- » 12" cast drive wheels and tires offer excellent maneuverability and control
- » 22" captain's seat and elegant shroud enhance its non-wheelchair appearance
- » Fitted with removable anti-tippers for increased safety
- » Optional elevating leg rests, oxygen tank holder, and rear basket



Item #	Seat Width	Seat Depth	Back Height	Wt w/o Battery	Weight Capacity	M.S.R.P.	Sugg. HCPCS
PC-1451M-AR/BL	22"	22"	22"	167 lbs	450 lbs	\$11,950	K0827

Tacahe Heavy Duty PC1465HD

- » Max Speed 5 Mph
- » Turn Radius 32"
- » Controller PG VR2 - 90 AH
- » Batteries 12V, 22NF x 2
- » Charger 6 Amp Offboard
- » Gradient 10°
- » Casters 9" Foam Filled Tires
- » Drive Wheels 14" Pneumatic Tires
- » Brakes Intelligent, Regenerative Electromagnetic Brakes
- » Overall Width 27"
- » Overall Length 45"
- » Unique suspension system provides a smooth and comfortable ride
- » 14" cast aluminum drive wheels and pneumatic tires offer excellent maneuverability and control
- » 22" captain's seat and elegant shroud enhance its non-wheelchair appearance
- » Fitted with removable anti-tippers for increased safety
- » Optional elevating leg rests, oxygen tank holder, and rear basket



Item #	Seat width	Seat Depth	Back Height	Wt w/o Battery	Weight Capacity	M.S.R.P.	Sugg. HCPCS
PC1465HD-AR/BL	22"	21"	21"	194 lbs	475 lbs	\$11,950	K0853

POWER WHEELCHAIRS & RELATED PRODUCTS

Tacahe Heavy Duty PC-P710V

- » Max Speed 5 Mph
- » Turn Radius 35"
- » Gnd. Clearance 3"
- » Controller PG VR2
- » Batteries 12V, 24NF x 2
- » Charger 6 Amp Offboard
- » Gradient 12°
- » Casters 9" Foam Filled Tires
- » Drive Wheels 12" Pneumatic Tires
- » Brakes Intelligent, Regenerative Electromagnetic Brakes
- » Overall Width 27"
- » Overall Length 43"



Item #	Seat Width	Seat Depth	Back Height	Wt w/o Battery	Weight Capacity	M.S.R.P.	Sugg. HCPCS
PC-P710VAR/BL	24"	20"	22"	213 lbs	600 lbs	\$11,950	K0827

Tacahe Rehab PC1450RHB

- » Max Speed 5 Mph
- » Turn Radius 32"
- » Controller VR2
- » Batteries 12V, 22NF x 2
- » Charger 6 Amp Offboard
- » Gradient 12°
- » Casters 9" Foam Filled Tires
- » Drive Wheels 14" Pneumatic Tires
- » Brakes Intelligent, Regenerative Electromagnetic Brakes
- » Overall Width 27"
- » Overall Length 44"



Item #	Seat Width	Seat Depth	Back Height	Wt w/o Battery	Weight Capacity	M.S.R.P.	Sugg. HCPCS
PC1450RHB	18" - 22"	18"	21"	204 lbs	450 lbs	\$11,950	K0827

POWER WHEELCHAIRS & RELATED PRODUCTS

ePower Pediatric PC1000TILT - Tilt in Space

- » Max Speed 5 Mph
- » Turn Radius 23"
- » Controller VSI 50 Amp
- » Batteries U-1 12V 34AH x2
- » Charger Offboard
- » Casters 8" x 2"
- » Drive Wheels 12.5" x 2 .25"
- » Brakes Electromagnetic Brakes
- » Power Tilt Yes
- » An aluminium framed pediatric power wheelchair equipped with a rehab seating tilt system



Item #	Seat Width	Seat Depth	Overall Width	Overall Length	Wt w/o Battery	Weight Capacity	M.S.R.P.
PC1000TILT	12" - 16" Options	Adjustable	25"	28"	143 lbs	220 lbs	\$13,950

Tacahe PC-7RTPL - Power Tilt-in-Space with Power Leg Rest

- » Max Speed 6 Mph
- » Turn Radius 34"
- » Controller VSI 70 Amp + A1
- » Batteries 12V 22NF x2
- » Charger 5 Amp Offboard
- » Casters 9.5" x 3"
- » Drive Wheels 14" x 3" Pneumatic Tires
- » Brakes Intelligent, Regenerative Electromagnetic Brakes
- » Standard 4-pole high power motors, incorporated with a tilt-in-space rehab seating system
- » Rear wheel drive designed for super maneuverability
- » Stylish with high performance and value
- » Superb climbing capability



Item #	Seat width	Overall Width	Overall Length	MSRP
PC-7RTPL	16", 18", 20", 22"	27"	46"	\$19,995

POWER WHEELCHAIRS & RELATED PRODUCTS

3 Wheel Scooter SC-S235

- » Max Speed 4.1 Mph
- » Turn Radius 40"
- » Gnd. Clearance 3.5"
- » Controller Dynamic Rhino 70 Amp
- » Batteries 12V, 22AH x2
- » Charger 4 Amp Offboard
- » Gradient 10°
- » Casters 8" Foam Filled Tires
- » Drive wheels 9" Foam Filled Tires
- » Brakes Intelligent, Regenerative Electromagnetic Brakes
- » High torque drive train allows for climbing over curbs and steps
- » Adjustable tiller height, and flip-up armrests with height, width and angle adjustments
- » Chrome steel bumper protects shroud from scratches and serves as a lift handle



Item #	Overall Width	Overall Length	Base	Battery	Seat Width	Seat Depth	Seat	TTL W/ Batt.	Weight Capacity	M.S.R.P.	Sugg. HCPCS
SC-S235AR/BL	23"	44"	73 lbs	28 lbs	17"	16"	24 lbs	129 lbs	300 lbs	\$2,295	K0806

3 Wheel Scooter SC-S135-400

- » Max Speed 4.5 Mph
- » Turn Radius 50"
- » Gnd. Clearance 4"
- » Controller Dynamic DI Rhino
- » Batteries U-1 12V 34AH X 2
- » Charger 5 Amp Offboard
- » Gradient 8°
- » Casters 10" Pneumatic Tires
- » Drive Wheels 10" Pneumatic Tires
- » Brakes Intelligent, Regenerative Electromagnetic Brakes
- » High torque drive train allows for climbing over curbs and steps
- » Adjustable tiller height, and flip-up armrests with height, width and angle adjustments
- » Standard headlight and turn lights
- » Chrome steel bumper protects shroud from scratches and serves as a lift handle



Item #	Overall Width	Overall Length	Base	Battery	Seat Width	Seat Depth	Seat	TTL w/ Batt.	Weight Capacity	M.S.R.P.	Sugg. HCPCS
SC-S135AR/BL-400	23"	46"	84 lbs	52 lbs	20"	18"	40 lbs	176 lbs	400 lbs	\$3,900	K0807

POWER WHEELCHAIRS & RELATED PRODUCTS

4 Wheel Scooter SC-S245

- » Max Speed 4.3 Mph
- » Turn Radius 53"
- » Gnd. Clearance 3.5"
- » Controller Dynamic Rhino 70 Amp
- » Batteries 12V, 22AH X2
- » Charger 4 Amp Offboard
- » Gradient 10°
- » Casters 9" Foam Filled Tires
- » Drive Wheels 9" Foam Filled Tires
- » Brakes Intelligent, Regenerative Electromagnetic Brakes
- » High torque drive train allows for climbing over curbs and steps
- » Adjustable tiller height, and flip-up armrests with height, width and angle adjustments
- » Chrome steel bumper protects shroud from scratches and serves as a lift handle



Item #	Overall Width	Overall Length	Base	Battery	Seat Width	Seat Depth	Seat	TTL w/ Batt.	Weight Capacity	M.S.R.P.	Sugg. HCPCS
SC-S245AR/BL	23"	46"	94 lbs	28 lbs	17"	16"	24 lbs	146 lbs	300 lbs	\$2,595	K0806

4 Wheel Scooter SC-S145-400







- » Max Speed 5.1 Mph
- » Turn Radius 63"
- » Gnd. Clearance 4"
- » Controller Dynamic DI Rhino
- » Batteries 12V/U1, 34AH X2
- » Charger 5 Amp Offboard
- » Gradient 8°
- » Casters 10" Pneumatic Tires
- » Drive Wheels 10" Pneumatic Tires
- » Brakes Intelligent, Regenerative Electromagnetic Brakes
- » High torque drive train allows for climbing over curbs and steps
- » Adjustable tiller height, and flip-up armrests with height, width and angle adjustments
- » Standard headlight and turn lights
- » Chrome steel bumper protects shroud from scratches and serves as a lift handle



Item #	Overall Width	Overall Length	Base	Battery	Seat Width	Seat Depth	Seat	TTL w/ Batt.	Weight Capacity	M.S.R.P.	Sugg. HCPCS
SC-S145AR/BL-400	23"	47"	97 lbs	52 lbs	20"	18"	40 lbs	189 lbs	400 lbs	\$4,790	K0807

POWER WHEELCHAIRS & RELATED PRODUCTS

Batteries

Item #	Description	Dimension(s) L x W x H (inches)	Weight	Use for the Following Model	M.S.R.P.	Sugg. HCPCS
BAT-1205	12V, 5AH	3 $\frac{1}{8}$ x 2 $\frac{1}{8}$ x 3 $\frac{1}{8}$	4 lbs	PL-4200E Electric Patient Lifter PL-650HD	\$95	N/A
						
BAT-1212	12V, 12AH	5 $\frac{1}{8}$ x 3 $\frac{1}{8}$ x 3 $\frac{1}{8}$	9 lbs	DALTON SC-43, Pride Go-Go® Merits S541, S549, P321	\$99	K0733
						
BAT-1222	12V, 22AH	7 $\frac{1}{8}$ x 2 $\frac{1}{8}$ x 6 $\frac{1}{2}$	15 lbs	DALTON : S235, S245, MP3C-2, MP3CJR CTM : HS-320, HS-360 IMC : P33, P53, PF6, PT3 Merits : Pioneer 1, Pioneer 2, P320 *Pride : Go-Go®, Traveller®plus/HD	\$125	K0733
						
BAT-U134	12V, 34AH	7 $\frac{1}{8}$ x 5 x 6 $\frac{1}{8}$	25 lbs	DALTON: ePower 16", 18", 20" MP3C, MP3C-1, MP3CM SC-135, SC-145 CTM : HS-570, 580, 666, 686 IMC : PF2, HP1, HP3, HP4, HP5 Merits : MP1-16", 18", 20", Pioneer 3 Pioneer 4, MP-3C, P326 Pride : Sundancer®, Legend® : Celebrity®, Victory®, Jazzy® : Select®, Select®6, Jazzy®1103 : Jet 3®, Jet 3® Ultra, Jet 7®	\$149	E2365
						
BAT-1250	12V, 50AH	8 $\frac{1}{8}$ x 6 $\frac{1}{2}$ x 6 $\frac{1}{2}$	31 lbs	DALTON : PC1450, PC1465, PC1350 IMC : PF1, HP1HD, HP3HD : HP6, HP7R	\$245	E2361
						
BAT-22NF	12V, 55AH	8 $\frac{1}{4}$ x 5 $\frac{1}{8}$ x 8 $\frac{1}{8}$	38 lbs	DALTON: ePower, 22", 24", 26", 28" PC1350, PC1451, MP3R14+ SC-135HD, 145HD Merits : S131-45D, S141-450, P201 HP-3RW, P181, P182, P183 P184, P301, P314, P327 Pride : Select®14, Jazzy®600/600XL, 614H,D, 1121, Jet 2®	\$265	E2361
						
BAT-24NF	12V, 75AH	10 $\frac{1}{8}$ x 6 $\frac{1}{8}$ x 7 $\frac{1}{8}$	56 lbs	DALTON : P710V, P720 Pride : Jazzy® 1100, 1170, 1420, 1650	\$325	E2363
						

* Go-Go, Go-Go Traveller, Sundancer, Legend, Celebrity, Victory, Jazzy, Jazzy Select, Jet are registered Trade Mark of Pride Mobility.

WHEELCHAIRS & RELATED PRODUCTS

eChair - Fixed Arm

- » Folding P. E. coated frame with fixed full arms
- » Padded flame retardant upholstery
- » Padded arm and calf pads for ELRs
- » 8" x 1" casters with hard rubber tires
- » 24" x 1" rear molded wheels with hard rubber tires
- » Cam-action, swing-away detachable foot rests or leg rests
- » Optional: Anti-tippers, Seat belt, Brake extension
Elevating leg rests HCPCS: K0195



Item #	Seat Width	Seat Depth	Back Height	Overall Width	Weight	Weight Limit	M.S.R.P	Sugg HCPCS
K01FX18F15	18"	16"	16½"	24½"	39 lbs	250 lbs	\$325	K0001
K01FX18L15	18"	16"	16½"	24½"	39 lbs	250 lbs	\$425	K0001
K01FX16F15	16"	16"	16½"	22½"	38 lbs	250 lbs	\$325	K0001
K01FX16L15	16"	16"	16½"	22½"	38 lbs	250 lbS	\$425	K0001

eChair - Detachable Arm

- » Folding P. E. coated frame with detachable arms
- » Padded flame retardant upholstery
- » 8" x 1" casters with hard rubber tires
- » 24" x 1" rear molded wheels with hard rubber tires
- » Cam-action, swing-away detachable foot rests or leg rests
- » Optional: Anti-tippers, Seat belt, Brake extensions
Elevating leg rests HCPCS: K0195



Item #	Seat Width	Seat Depth	Back Height	Overall Width	Weight	Weight Limit	M.S.R.P	Sugg HCPCS
K01DK18F15	18"	16"	16½"	26½"	42 lbs	250 lbs	\$385	K0001
K01DK18L15	18"	16"	16½"	26½"	42 lbs	250 lbs	\$485	K0001
K01DK16F15	16"	16"	16½"	24½"	40 lbs	250 lbs	\$385	K0001
K01DK16L15	16"	16"	16½"	24½"	40 lbs	250 lbS	\$485	K0001

eChair Recliner

- » Folding triple chrome plated frame with detachable arms
- » Hydraulic assist cylinders recline back from 90° to 180°
- » Padded flame retardant upholstery
- » 8" x 1" casters with hard rubber tires
- » 24" x 1" rear molded wheels with hard rubber tires
- » Adjustable toggle wheel locks
- » Elevating leg rests HCPCS: K1095, Recline back HCPCS: E1226,
Anti-tippers HCPCS: E0971
- » Optional: Seat belt HCPCS: E0978



Item #	Seat Width	Seat Depth	Back Height	Overall Width	Weight	Weight Limit	M.S.R.P	Sugg HCPCS
CM477A16L	16"	17"	33"	24"	50 lbs	250 lbs	\$895	K0001
CM477A18L	18"	17"	33"	26"	51 lbs	250 lbs	\$895	K0001
CM477A20L	20"	17"	33"	28"	52 lbs	310 lbs	\$1,095	K0001

WHEELCHAIRS & RELATED PRODUCTS

eChair Recliner - Deluxe Wide

- » Folding triple chrome plated frame with detachable arms
- » Hydraulic assist cylinders recline back from 90° to 180°
- » Padded flame retardant upholstery
- » 8" x 2" casters with hard rubber tires
- » 24" x 1 3/8" rear molded wheels with hard rubber tires
- » Comes with elevating leg rests
- » Optimal: Seat belt



Item #	Seat Width	Seat Depth	Back Height	Overall Width	Weight	Weight Limit	M.S.R.P	Sugg HCPCS
K477DK22LHD	22"	17"	33"	30.5"	66 lbs	350 lbs	\$2,195	K0007
K477DK24LHD	24"	17"	33"	32.5"	77 lbs	370 lbs	\$2,395	K0007

eChair Recliner - Pediatric

- » Folding triple chrome plated frame with detachable arms
- » Hydraulic assist cylinders recline back from 90° to 180°
- » Padded flame retardant upholstery
- » 5" x 1.38" casters with hard rubber tires
- » 20" x 1 3/8" rear pneumatic tires
- » Comes with elevating leg rests
- » Optional: Seat belt



Item #	Seat Width	Seat Depth	Back Height	Overall Width	Weight	Weight Limit	M.S.R.P	Sugg HCPCS
K476DK14L	14"	15"	23"	22.5"	46 lbs	250 lbs	\$1,595	K0001

Chair Wide Deluxe

- » Folding, P. E. Coated frame with detachable desk arms
- » Padded flame retardant upholstery
- » Padded arms and calf pads for ELRs
- » Dual axles for converting to hemi-height
- » 8" front, 24" rear molded wheels with hard rubber tires
- » Cam-action, swing-away detachable foot rests or leg rests
- » Optional: Anti-tippers, Seat belt, Brake extensions
Elevating leg rests HCPCS: K0195



Item #	Seat Width	Seat Depth	Back Height	Overall Width	Weight	Weight Limit	M.S.R.P	Sugg HCPCS
K07DK20F02	20"	18"	16 1/2"	28"	51 lbs	310 lbs	\$595	K0007
K07DK20L02	20"	18"	17"	28"	51 lbs	310 lbs	\$695	K0007
K07DK22F02	22"	18"	17"	30"	53 lbs	350 lbs	\$725	K0007
K07DK22L02	22"	18"	17"	30"	53 lbs	350 lbs	\$825	K0007
K07DK24F02	24"	18"	17"	32"	55 lbs	400 lbs	\$925	K0007
K07DK24L02	24"	18"	17"	32"	55 lbs	400 lbs	\$1,025	K0007

WHEELCHAIRS & RELATED PRODUCTS

eChair - Bariatric

- » Reinforced frame with double cross brace offers a rugged, heavy duty wheelchair for bariatric users
- » Detachable desk arms
- » 24" x 1" spoke rear wheels with solid tires and M15 axles
- » 8" x 1" solid casters with H.D. forks and 1" stems
- » Elevating leg rests HCPCS: K0195
- » Optional: Anti-tippers, Seat belt, Brake extensions



Item #	Seat Width	Seat Depth	Overall Width	Weight	Weight Limit	M.S.R.P	Sugg HCPCS
K07DK26LSPW	26"	20"	34.5"	58 lbs	500 lbs	\$1,395	K0007
K07DK28LSPW	28"	20"	36.5"	60 lbs	550 lbs	\$1,595	K0007
K07DK30LSPW	30"	20"	38.5"	62 lbs	600 lbs	\$1,795	K0007

eChair - Deluxe Bariatric

- » Reinforced frame offers a comfortable heavy duty wheelchair for bariatric uses
- » Aluminium seat pan with cushion
- » 9" front castors
- » 24" x 2 1/8" rear wheels
- » Adjustable seat depth



Item #	Seat Width	Seat Depth	Back Height	Overall Width	Weight	Weight Limit	M.S.R.P	Sugg HCPCS
K07DK26RTL	26"	20"-24"	23"	36"	140 lbs	650 lbs	\$2,195	K0007
K07DK28RTL	28"	20"-24"	23"	38"	145 lbs	650 lbs	\$2,495	K0007

eLite

- » Folding, lightweight, chrome-plated frame
- » Padded, flame retardant, nylon upholstery
- » Padded, desk length, swing-back arms
- » 8" front, 24" rear lightweight polyurethane tires
- » Cam-action, swing-away detachable foot rests
- » High-impact composite side panel and foot plates
- » Dual rear axle positioning for adult and hemi seat heights
- » Optional: Elevating leg rests HCPCS: K0195



Item #	Seat Width	Seat Depth	Overall Width	Weight	Weight Limit	M.S.R.P	Sugg HCPCS
K3DK16F/L0215	16"	16"	24"	34 lbs	250 lbs	\$595/\$645	K0003
K3DK18F/L0215	18"	16"	26"	35 lbs	250 lbs	\$595/\$645	K0003
K3DK20F/L0215	20"	16"	28"	36 lbs	250 lbs	\$695/\$745	K0003

WHEELCHAIRS & RELATED PRODUCTS

Jaguar - High Strength Lightweight

- » Dual axle positioning for both adult and hemi seat heights
- » High-strength, lightweight wheelchair
- » Lightweight, padded back nylon upholstery
- » Flat-free AERO tires
- » Optional: Adjustable height arms HCPCS: E0973
Elevating leg rests HCPCS: K0195



Item #	Seat Width	Seat Depth	Overall Width	Weight	M.S.R.P	Sugg HCPCS
K418F02	18"	16"	25"	32 lbs	\$713	K0004
K418L02	18"	16"	25"	32 lbs	\$813	K0004
K416F02	16"	16"	23"	31 lbs	\$713	K0004
K416L02	16"	16"	23"	31 lbs	\$813	K0004
K420F02	20"	18"	27"	33 lbs	\$775	K0004
K420L02	20"	18"	27"	33 lbs	\$875	K0004

eLite Pediatric Chair

- » Designed to fit children and small adults
- » Detachable desk length arms
- » Vertical swing away foot rests
- » 22" x 1 $\frac{3}{8}$ " mag rear wheels with pneumatic tires
- » 6" x 1" solid casters with aluminum forks
- » Optional: Elevating leg rests HCPCS: K0195



Item #	Seat Width	Seat Depth	Overall Width	Weight	Weight Limit	M.S.R.P	Sugg HCPCS
K3DK14F/L	14"	14"	21"	33 lbs	180 lbs	\$695/\$795	K0003
K3DK12F/L	12"	12"	19"	32 lbs	180 lbs	\$695/\$795	K0003

Rehab Tilt-in-Space - Adult

- » Aluminum wheelchair features manually operated tilting and reclining functions
- » Ergonomic seating system with extendable armrests
- » 8" x 2" front casters
- » 24" real wheels with quick release axles & pneumatic airless tires
- » Tilting angle: 5~25 degrees
- » Reclining angle: 30 degrees
- » Contour seat cushions



Item #	Seat Width	Seat Depth	Overall Width	Weight	Weight Limit	M.S.R.P
K518	18"	18.5"	27.5"	80 lbs	250 lbs	\$2,495
K521	21"	18.5"	29.5"	80 lbs	300 lbs	\$2,495

WHEELCHAIRS & RELATED PRODUCTS

Tilt-in-Space: Pediatric

- » Aluminum wheelchair features manually operated tilting and reclining functions
- » Tilting angle: 5~25 degrees
- » Reclining angle: 30 degrees
- » 20" rear spoked wheels with pneumatic tires
- » 6" cast wheels with airless tires
- » Contour seat cushion
- » Quick release and multi-position rear axle
- » Optional: Side lateral support, Foot support, Elevating leg rest, Butterfly chest belt, Head rest, Pommel device



Item #	Seat Width	Seat Depth	Overall Width	Weight	Weight Limit	M.S.R.P
K514	14"	13-16"	23"	57 lbs	220 lbs	\$2,495

Combo

- » Can be used as standard self propelled wheelchair or a transport chair all-in-one.
- » Aluminum lightweight frame
- » Comes with two sets of brakes: One for use with wheelchair, another for use with transport chair.
- » Flip-up armrests
- » Nylon upholstery
- » Swing-away foot rests with heel loops



Item #	Seat Width	Seat Depth	Back Height	Overall Width	Weight	Weight Limit	M.S.R.P
K409	18"	16"	16"	27"	33 lbs	220 lbs	\$695

Aircraft Boarding Chair

- » P.E. coated main frame
- » Padded P.V.C. upholstery
- » Comes with 1 pair of 5 point crossing belt restraint, 1 pc. thigh restraint, 1 pc. leg restraint



Item #	Seat Width	Seat Depth	Total Height	Weight Limit	M.S.R.P
K09FX13F	13.5"	16"	40"	300 lbs	\$595
K09FX13FHD	13.5"	17"	40"	400 lbs	\$695

WHEELCHAIRS & RELATED PRODUCTS



Standard Transporter Wheelchair

- » 8" x 1" casters with hard rubber tires
- » Adjustable toggle wheel locks
- » Cam-action, swing-away detachable footrests
- » High-impact composite foot plates and Velcro strap
- » Folding chrome-plated frame with fold down back



Item #	Seat Width	Seat Depth	Overall Width	Weight Limit	Weight Limit	M.S.R.P	Sugg HCPCS
K09FX18F	18"	16"	20¾"	25.8 lbs	220 lbs	\$299	E1038
K09FX18FL	18"	16"	20¾"	25.8 lbs	220 lbs	\$399	E1038
K09FX20F	20"	16"	22¾"	27 lbs	250 lbs	\$345	E1038
K09DK22F02	22"	18"	28¾"	42 lbs	400 lbs	\$395	E1038

Wheelchair Accessories

				
Anti-Tipping Device	Brake Extension Tube	Oxygen Tank Holder	Stump Support	I.V. Rod Attachment
				
Seat Belt	Butterfly Chest Strap	Wheelchair Trays 18"x20" Molded Plastic Velcto Straps	Transfer Board 220 lbs. limit, 29.5"x7.5" 600 lbs. limit, 32"x10"	Solid Seat Insert, 17"x16" Provides solid base to prevent hammocking & designed to be used with cushioning

Item #	Type	Fit For	M.S.R.P.	Sugg. HCPCS					
ZE-A1034	Anti-Tipping Device	E-chair	\$119/pr	E0971	I-V310WC	I. V. Rod Attachment	Universal	\$139	K0105
ZJ-A1035	Anti-Tipping Device	Jaguars	\$119/pr	E0971	ZE-SEBELT48	Seat Belts	Universal	\$59	E0978
ZE-A1034C	Anti-Tipping Device	Clamp on	\$119/pr	E0971	ZE-SEBELT60	Seat Belts	Universal	\$69	E0978
Z-A2101	Brake Extension Tubes	Universal	\$59/pr	E0961	Z-AC091096	Butterfly Chest Strap	Universal	\$90	N/A
Z-A2106	Brake Extension Tubes	Universal	\$59/pr	E0961	Z-T10	Wheelchair Tray	Universal	\$120	E0950
Z-A2108	Brake Extension Tubes	Universal	\$59/pr	E0961		Transfer Boards			
R-X100	Oxygen Tank Holder	Universal	\$65	E2208	CA-0305 (220 lbs)	Transfer Boards	Universal	\$69	N/A
STUM-31553	Stump Support	Universal	\$249	E1020	Z-31529 (600 lbs)	Transfer Boards	Universal	\$199	N/A
					CA225325-18	Solid Seat Insert	Universal	\$109	E0992

WHEELCHAIRS & RELATED PRODUCTS

Light Weight Transporter Wheelchair

- » Folding ultra-light aluminum frame with fold down back and fixed full-length arms
- » 8" x 1" casters with light polyurethane tires
- » Cam-action, swing-away detachable foot rests
- » Adjustable toggle wheel locks
- » High-impact composite foot plates
- » Optional: Seat belt



Item #	Seat Width	Seat Depth	Overall Width	Weight Limit	Weight Limit	M.S.R.P	Sugg HCPCS
K09FX17FA	17"	16"	20¾"	18 lbs	220 lbs	\$345	E1038
K09FX17FAL	17"	16"	20¾"	18 lbs	220 lbs	\$425	E1038
K09FX19FA	19"	16"	22¾"	19 lbs	220 lbs	\$395	E1038
K09FX19FAL	19"	16"	22¾"	19 lbs	220 lbs	\$425	E1038

General Use Wheelchair Seat Cushion

- » Foam Cushion (Nylon Waterproof Cover)



Item #	Size	Case Qty.	M.S.R.P.	Sugg. HCPCS
PMC-8063	16" x 16" x 3"	4	\$79	E2601
PMC-8064	18" x 16" x 3"	4	\$79	E2601
PMC-8065	20" x 18" x 3"	4	\$86	E2601
PMC-8077	22" x 18" x 3"	4	\$125	E2602
PMC-8080	24" x 18" x 3"	4	\$145	E2602
PMC-8081	26" x 18" x 3"	4	\$195	E2602
PMC-8082	26" x 20" x 4"	4	\$299	E2602
PMC-8064-30	30" x 20" x 4"	4	\$289	E2602

Skin Protection & Positioning Wheelchair Seat Cushions

- » Multiple Purpose Cushion (Multi-layered Gel Cushion with Visco Memory Foam)

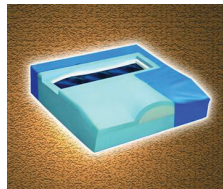

Item #	Size	Case Qty.	M.S.R.P.	Sugg. HCPCS
PMC-FPT10HP1	16" x 16" x 3"	1	\$345	E2607
PMC-FPT10HP2	18" x 16" x 3"	1	\$345	E2607
PMC-FPT10HP3	20" x 18" x 3"	1	\$365	E2607
PMC-FPT10HP4	22" x 18" x 3"	1	\$415	E2608
PMC-FPT10HP6	24" x 18" x 3"	1	\$445	E2608

Invalid Cushions

- » Relieves seating pressure associated with surgery or discomfort



Item #	Size	Case Qty	M.S.R.P	Sugg. HCPCS
PMC-8086	Medium	EA	\$22	N/A

Contour Kabooti

- » Combines Coccyx Cushion with Donut Ring
- » Designed for use at home, office or in the car
- » New shape enhances patient stability and comfort
- » Upscale cover is soft and breathable
- » Cover available in blue or gray

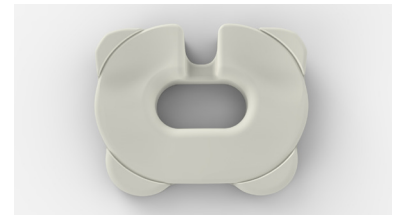

Item #	Size	Qty.
PMC-KABRING	17.3" x 2.8" x 13.7"	6/cs

WHEELCHAIRS & RELATED PRODUCTS

Air Cushions



Roho Quadtro Select ®



Air-Cell Cushion

Item #	Size	M.S.R.P	Sugg. HCPCS
PM-QS66C	12" x 12" x 4"	\$454	K2624
PM-QS66LPC	12" x 12" x 2"	\$454	K2624
PM-QS67C	12" x 13" x 4"	\$454	K2624
PM-QS67LPC	12" x 13" x 2"	\$454	K2624
PM-QS77C	13" x 13" x 4"	\$454	K2624
PM-QS77LPC	13" x 13" x 2"	\$454	K2624
PM-QS76C	13" x 12" x 4"	\$454	K2624
PM-QS76LPC	13" x 12" x 2"	\$454	K2624
PM-QS88C	14" x 14" x 4"	\$454	K2624
PM-QS88LPC	14" x 14" x 2"	\$454	K2624
PM-QS87C	14" x 13" x 4"	\$454	K2624
PM-QS87LPC	14" x 13" x 2"	\$454	K2624
PM-QS98C	16" x 14" x 4"	\$454	K2624
PM-QS98LPC	16" x 14" x 2"	\$454	K2624
PM-QS99C	16" x 16" x 4"	\$454	K2624
PM-QS99LPC	16" x 16" x 2"	\$454	K2624
PM-QS109C	18" x 16" x 4"	\$454	K2624
PM-QS109LPC	18" x 16" x 2"	\$454	K2624
PM-QS1010C	18" x 18" x 4"	\$454	K2624
PM-QS1010LPC	18" x 18" x 2"	\$454	K2624
PM-QS119C	20" x 16" x 4"	\$454	K2624
PM-QS119LPC	20" x 16" x 2"	\$454	K2624
PM-QS1110C	20" x 18" x 4"	\$454	K2624
PM-QS1110LPC	20" x 18" x 2"	\$454	K2624
PM-QS1210C	22" x 18" x 4"	\$504	K2625
PM-QS1210LPC	22" x 18" x 2"	\$504	K2625
PMC-8047-16	16" x 16" x 4"	\$375	K2622
PMC-8047-18	18" x 16" x 4"	\$375	K2622
PMC-8047-20	20" x 18" x 4"	\$375	K2622
PMC-8047-22	22" x 18" x 4"	\$425	K2623

Wedge Cushions & Pommel

- » Prevents patient from sliding
- » Insures seating comfort

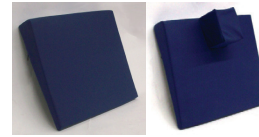

PMC-8134 PMC-8160-P

Item #	Size	M.S.R.P
PMC-8133	16" x 16" x 3" to 1"	\$145
PMC-8134	18" x 16" x 3" to 1"	\$165
PMC-8135	20" x 16" x 3" to 1"	\$195
PMC-8136	22" x 18" x 4" to 1"	\$235
PMC-8160-P	16" x 16" x 3" to 1"	\$175
PMC-8161-P	18" x 16" x 3" to 1"	\$195
PMC-8162-P	20" x 16" x 3" to 1"	\$235



Skin Protection

Wheelchair Seat Cushion

- » Gel/Foam Cushion (Nylon Waterproof Cover)

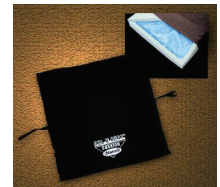

Item #	Size	Case Qty.	M.S.R.P.	Sugg. HCPCS
PMC-80460	14" x 14" x 3"	4	\$189	E2603
PMC-80461	16" x 16" x 3"	4	\$189	E2603
PMC-80462	18" x 16" x 3"	4	\$189	E2603
PMC-80463	20" x 16" x 3"	4	\$199	E2603
PMC-80464	20" x 18" x 3"	4	\$199	E2603
PMC-80465	22" x 18" x 3"	4	\$239	E2604
PMC-80466	22" x 20" x 3"	4	\$249	E2604
PMC-80467	24" x 18" x 3"	4	\$249	E2604
PMC-80468	24" x 20" x 3"	4	\$259	E2604
PMC-80469	26" x 18" x 3"	4	\$259	E2604
PMC-80470	28" x 20" x 3"	4	\$269	E2604
PMC-80471	30" x 20" x 3"	4	\$315	E2604

Back Cushion

- » Contoured foam back cushion conforms to provide support and comfort to the lumbar region and upper back
- » Secure straps fit all wheelchairs



Item #	Size	M.S.R.P	Sugg. HCPCS
PMC-8030	16" W x 16" L	\$325	E2611
PMC-8031	18" W x 17" L	\$325	E2611
PMC-8032	20" W x 19" L	\$325	E2611
PMC-8033	22" W x 19" L	\$395	E2612
PMC-8034	24" W x 19" L	\$450	E2612

WHEELCHAIRS & RELATED PRODUCTS

Power Chair Scooter Accessories

Rear-View Mirror for Scooter



Item #	M.S.R.P
ZM-S135MIRROR	\$29

Rear Basket



Item #	M.S.R.P
ZC-SCBASKET-R	\$79

Cup Holder



Item #	M.S.R.P
ZR-ACCASMB1086	\$39
ZM-ACCUPASMB	\$34

Oxygen Tank Holder



Item #	M.S.R.P
ZM-P1-100X	\$149
ZM-P3-100X	\$149

Safety Flag



Item #	M.S.R.P
PC-FLAG	\$15
PC-FLAGADP	\$15

Walker Holder



Item #	M.S.R.P
ZR-ACCASMB1912	\$165
ZM-ACC6106	\$145

Multi-Pocket Backpack



Item #	M.S.R.P
ZCF-E263-023A (Mat.: Canvas)	\$99

Rear Basket



Item #	M.S.R.P
ZR-ACCASMB1914	\$149

Front Basket



Item #	M.S.R.P
ZC-SCBASKET-F	\$89

Cane/Crutch Holder



Item #	M.S.R.P
ZR-ACCASMB1972	\$199
ZM-ACC200C	\$129

Backpack Bucket



Item #	M.S.R.P
ZCF-E263-024A (Mat.: 100% Cotton Canvas)	\$99

WHEELCHAIRS & RELATED PRODUCTS

Battery Tester & Chargers



BAT-T100H



Off-board
Charger



ZM-CHARG1345

Item #	Description	M.S.R.P	Sugg. HCPCS
BAT-T100H	Battery Tester	\$99	N/A
ZM-CHARG1.5A	1.5 AMP, off board for SC-43	\$189	E2366
ZM-CHARG1345	3 AMP, on board for SC135, S145	\$195	E2366
ZK-CHARG5A	5 AMP, off board	\$197	E2366
ZM-CHARG6A	6 AMP, off board	\$204	E2366
ZK-CHARG-8A	8 AMP, off board for 1450/1465	\$215	E2366

Joysticks



DYNAMIC SHARK2



DYNAMIC SHARK



P&G VSI



P&G VR2

Category	Item #	Compatibility	M.S.R.P.
DYNAMIC SHARK	ZM-JSDK-REMA02	MP3CJR R14+(2ND Gen) P710(2ND Gen)	\$895
DYNAMIC SHARK 2	ZM-JSDK-REMD01	1465 MP3CM2 MP3CM MP3CM20	\$895
P&G VSI	ZK-P3-CTL9301V	MP3C-1	\$1,495
	ZK-P4-CTRL-PG	1450(1ST Gen)	\$1,495
	ZK-P1A-CTRL-PG	16" - 20" ePower-1 16" - 20" ePower ALT 16" - 20" ePower	\$1,495
	ZM-CTLVSI70A	P710(1st Gen) 22" - 28" ePower 22" - 28" ePower-1	\$1,495
P&G VR2	ZM-JSVR2-P347	MP3C-2 R14+(3rd Gen) 1451 1450(2nd Gen) P710V P720	\$895

Power Modules



DYNAMIC



P&G VR2



DYNAMIC RHINO

Category	Item #	Compatibility	M.S.R.P.
DYNAMIC	ZM-CTLDK-PMB40	MP3CM MP3CM20	\$845
	ZM-DK-PMA01	R14+(2nd Gen)	\$995
	ZM-DK-PMA05	P710(2nd Gen) MP3JR	\$995
	ZK-CTLDKPMC01	1465	\$1,095
P&G VR2	ZM-CTLVR2-40A	MP3C-2	\$895
	ZM-CTLVR2-60A	1451 R14+(3rd Gen) P710V P720	\$945
	ZK-CTLVR5-90A	1450(2nd Gen)	\$1,995
DYNAMIC RHINO	ZM-SCTL1-DS112	S135 S145 S135HD S145HD	\$645
	ZM-SCTL2-DS72	S235 S245	\$595

WHEELCHAIRS & RELATED PRODUCTS

Wheelchair Ramps

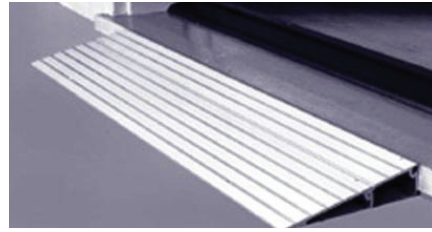

SPECIFICATIONS	THRESH 1	THRESH 1.5	THRESH 2	THRESH 3	THRESH 4	THRESH 5	THRESH6
Limit of use	³ / ₄ " to 1 ¹ / ₄ "	1 ¹ / ₄ " to 1 ³ / ₄ "	1 ³ / ₄ " to 2 ¹ / ₄ "	2 ³ / ₄ " to 3 ¹ / ₄ "	3 ³ / ₄ " to 4 ¹ / ₄ "	4 ³ / ₄ " to 5 ¹ / ₄ "	5 ³ / ₄ " to 6 ¹ / ₄ "
Length	6 1/2"	9 1/2"	12"	17"	22 1/2"	27 1/2"	32 3/4"
Ramp weight	3 lbs*	5 lbs*	5 1/2 lbs*	8 lbs*	11 lbs*	15 lbs*	20 lbs*
Ramp width	34"	34"	34"	34"	34"	34"	34"
Weight capacity	600 lbs	600 lbs	600 lbs	600 lbs	600 lbs	600 lbs	600 lbs
Usage guidelines	Sliding doors, thresholds	Sliding doors, thresholds, raised landings	Sliding doors, thresholds, raised landings	Sliding doors, thresholds, raised landings	Sliding doors, thresholds, raised landings	Sliding doors, thresholds, raised landings	Sliding doors, thresholds, raised landings

» *Weights are approximate and may vary.

» Consult your equipment's owner guide for proper degree of incline. Never exceed its recommendations.

SPECIFICATIONS	SUITCASE 3	SUITCASE 4	SUITCASE 5	SUITCASE 6	TRIFOLD8	TRIFOLD10
Usable size	3' x 29" x 2"	4' x 29" x 2"	5' x 29" x 2"	6' x 29" x 2"	8' x 29 1/2"	10' x 29 1/2"
Folded size	3' x 15"	4' x 15"	5' x 15"	6' x 15"	48 ³ / ₄ " x 15" x 11 ¹ / ₂ "	60 ³ / ₄ " x 15" x 11 ¹ / ₂ "
Ramp weight	15 lbs*	21 lbs*	26 lbs*	36 lbs*	50 lbs*	60 lbs*
Inside (usable) width	29"	29"	29"	29"	29"	29"
Weight capacity	600 lbs	600 lbs	600 lbs	600 lbs	800 lbs	800 lbs
Outside width	29 1/2"	29 1/2"	29 1/2"	29 1/2"	29 1/2"	29 1/2"
Degree of incline. Never exceed manufacturer's recommendations.	Curbs, 1 step	Curbs, 1-2 steps	Curbs, 1-2 steps	Curbs, 1-2 steps	2 - 3 steps	2 - 4 steps

CPAP DEVICES & ACCESSORIES

IntelliPAP

- » Whisper-quiet operation - among the quietest CPAP units on the market, operating at only 26 dBA
- » Three, large buttons control nearly all the functions for simple operation.
- » Clean, sophisticated appearance and compact size easily fits into any home environment
- » Large, slip-resistant pads on the bottom of unit minimize movement on night table.
- » Air tubing conveniently connects to back of unit to reduce clutter.
- » Easy-to-access air inlet filter for washing and cleaning



PAP-DV51D-HH



PAP-DV55D-HH



PAP-DV54D-HH

Item #	Description
PAP-DV51D-HH	IntelliPAP Standard
PAP-DV53D-HH	IntelliPAP Standard Plus
PAP-DV54D-HH	IntelliPAP Auto Adjust
PAP-DV54D-HHS	IntelliPAP Auto Adjust with Data Cord
PAP-DV55D-HH	IntelliPAP BILEVEL

The Bravo

- » Interchangeable nasal pillows and Adaptive-Flow technology results in an extremely quiet sleep experience
- » Active-Swivel® feature allows user to wear in multiple positions, resulting in the highest levels of comfort
- » The Bravo Nasal Pillow System contains all of the components required to properly fit the patient, eliminating the hassle of opening multiple products to get the right fit
- » Sugg. HSPCS: A7034, A7035, A7033, A7035



Item #	Description	M.S.R.P
PAP-BRV600	Bravo - Nasal Pillow System	\$249

Hybrid Universal Interface

- » Serves as a nasal interface, an oral interface, and a combination of the two
- » A dual airway interface for use with positive pressure ventilation devices for the treatment of respiratory insufficiencies and obstructive sleep apnea
- » Promotes patient comfort by eliminating pressure points on the forehead and across the bridge of the nose
- » A built-in chin flap gently supports the chin, ensuring optimal performance
- » Sugg. HCPCS: ORAL/NASAL MASK-A7027, HEADGEAR-A7035



Item #	Description	M.S.R.P
PAP-HYB500	Hybrid - All Sizes Complete System	\$249

CPAP DEVICES & ACCESSORIES

Sandman Auto CPAP

- » Wide pressure range (3 cm to 20 cm H2O)
- » Auto adjust pressure throughout the night for optimum therapy level at all times
- » Automatic altitude and leak compensation
- » Sandman therapy software available to download data from memory card
- » Auto calibration of entire user circuit, including compensating for length of CPAP tubing and style of mask



SleepWeaver

- » The mask inflates like a balloon and softly conforms to any face creating an intimate seal
- » Sleep is possible in any position with this flexible fabric
- » Works on all pressures from 4 cm - 20 cm
- » Easy to fit, clean by hand or in the washing machine
- » Sugg. HCPCS: MASK-A7034, HEADGEAR-A7035
- » One size fits most



Item #	Description	M.S.R.P
PAP-SW100332	Nasal Mask and Headgear	\$199

Full Face Mask

- » Vent holes provide quiet & effective CO₂ washout
- » Anatomically contoured for comfort, fit and seal
- » 360° rotation and floating elbow for easy selection of oxygen tube position, preventing tube being pulled or dragged



Item #	Description	M.S.R.P
R-100FS	Comfort Fit Full Face Mask with Headgear, Small	\$197
R-100FM	Comfort Fit full Face Mask with Headgear, Medium	\$197
R-100FL	Comfort Fit full Face Mask with Headgear, Large	\$197

Nasal Cannula System(Home Care)

- » 4 sizes of nasal insets
- » 2 sizes of adjustable headgear
- » Patient circuit with swivel connector
- » Tubing clips & headgear padding
- » Convenient nylon carrying case



Item #	Description	M.S.R.P
R-CS9000-1	Reusable Nasal CPAP Cannula System	\$189

Contour CPAP Pillow

- » Sleep comfortably all night with any CPAP mask
- » Improve comfort and compliance, reduce mask shifting, leaks and the tendency to over-tighten mask straps
- » Minimize facial pressure that can cause discomfort, sores, even bruising around the mask seal area
- » Enjoy the freedom of sleeping in any position comfortably



Item #	Pillow Height	Pkg.	M.S.R.P
PAP-14101R1730	4"	4/cs	\$36 ea
PAP-14301R887	5"	4/cs	\$42 ea

Sylent Nasal CPAP Mask with Headgear

- » Provides support and comfort while reducing noise
- » Cushion inflates to create a strong seal, thereby reducing the possibility of air leakage and eliminating the need to tighten headgear.
- » Self-adjusting flexible forehead support offers three heights as well as a wide range of angle positions.
- » Sugg. HCPCS: MASK-A7034, HEADGEAR-A7035, CUSHION-A7302



Item #	Description	M.S.R.P
PAP-SYL203	Sylent Nasal Mask with Headgear	\$199

CPAP DEVICES & ACCESSORIES

CPAP / BIPAP Masks, Cushions & Pillows



PAP-CM011LP



PAP-CMHC452



R-9352G-604



R-9351D-660

Item #	Description
PAP-CMHC452	Fisher&Paykel Oracle Oral Mask
PAP-CM011LP	Breeze/ADAM Replacement Pillows, Pair - Large Green
R-9352G-604	Replacement Gel Pads & Vent
R-9351D-660	Replacement Seal Rings, Large

CPAP Mask Wipes and Spray

- » 62 wipes in each canister
- » Wipes made of pure cotton



Item #	Description	Pkg.
PAP-149751901	CPAP Spray 8 oz.	12/cs
PAP-149501899	CPAP Wipe - Unscented	12/cs

Breeze Sleep Gear Nasal Pillows Mask

- » No straps against the cheeks mean no red marks in the morning
- » Easily fits any patient
- » 4 sizes of standard pillows and 3 sizes of dilator pillows (S,M,L) with longer stems to reach further into the nares of the nostril
- » HCPCS Code: Mask (A7034), Headgear (A7035)



PAP-CM012

Opus 360 Nasal Pillows Mask

- » Off-the-lip pillows design is great for patients with facial hair or teeth sensitivity
- » Tube rotates 360°
- » New headgear design allows patients to remove the mask for cleaning without having to readjust the strap



PAP-CMHC482

CPAP DEVICES & ACCESSORIES

CPAP / BIPAP Accessories

		
PAP-BF2200	R-MP1080	COV-GKH20
		
PAP-CAP3001-3004	PAP-HUMHC365	PAP-HUMHC385
		
PAP-RES016	PAP-HHU19018	PAP-HG001
		
PAP-HG003	PAP-HG004	PAP-HG007
		
PAP-HG017	R-AG-1642	R-AG-CP7041
		
	PAP-TUB(002-010)	

Item #	Description
PAP-BF2200	CPAP Final Bacteria Filter
R-MP1080	CPAP Handheld Pressure Meter measures flow 0-18 cm/H2O
COV-GKH20	Good Night Heated Humidifier
PAP-CAP3001-3004	RemZZs Mask Liners
PAP-HUMHC365	Fisher&Paykel SleepStyle 600 series Humidifier Chamber
PAP-HUMHC385	Fisher&Paykel SleepStyle 200 Series Humidifier Chamber
PAP-RES016	Humidifier Tubing Adapter
PAP-HHU19018	Hybernite HCPCS A4606
PAP-HG001	Universal Mesh Headgear
PAP-HG003	Universal Headgear
PAP-HG004	Universal Full Face Headgear
PAP-HG007	ADAM Style Headgear
PAP-HG017	Sleepweaver Headgear
R-AG-1642	Oxygen Enrichment Adaptor, 22mm with 6mm Stem
R-AG-CP7041	Swivel CPAP Connector
PAP-TUB(0018-010)	TUB002 2ft TUB004 4ft TUB006 6ft TUB008 8ft TUB010 10ft Gray

CPAP DEVICES & ACCESSORIES

CPAP Filters

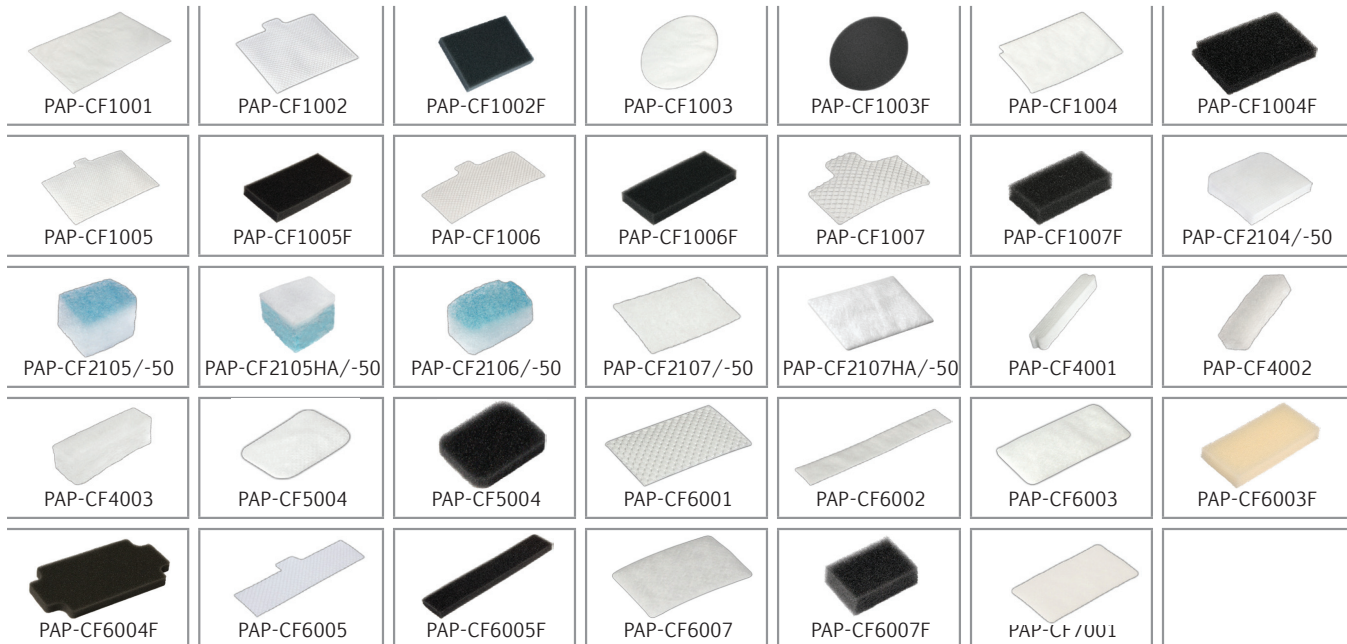

Item #	Description	Dim.	Qty.
PAP-CF1001	Respironics SleepEasy/BiPAP Ultrafine	7 $\frac{1}{4}$ " x 5"	6/pk
PAP-CF1002	Respironics Solo, Aria LX, REMStar LS Ultrafine	3 $\frac{1}{4}$ " x 2 $\frac{3}{4}$ "	6/pk
PAP-CF1002F	Respironics Solo, Aria LX, REMStar LX Foam	3 $\frac{1}{16}$ " x 2 $\frac{1}{2}$ "	2/pk
PAP-CF1003	Respironics REMStar Ultrafine	5 $\frac{1}{2}$ " x 4 $\frac{1}{4}$ "	6/pk
PAP-CF1003F	Respironics REMStar Foam	5 $\frac{1}{4}$ " x 5 $\frac{1}{4}$ "	1/pk
PAP-CF1004	Respironics Avria, Virtuoso Duet, Quartet Ultrafine	3 $\frac{3}{16}$ " x 2 $\frac{1}{16}$ "	6/pk
PAP-CF1004F	Respironics Avria, Virtuoso Duet, Quartet Foam	3 $\frac{3}{16}$ " x 2 $\frac{1}{4}$ "	2/pk
PAP-CF1005	Respironics BiPAP Pro/+, Duet LX, Sync. Ultrafine	4 $\frac{1}{4}$ " x 2 $\frac{1}{4}$ "	6/pk
PAP-CF1005F	Respironics BiPAP Pro/+, Duet LX, Sync. Foam	4 $\frac{1}{4}$ " x 2 $\frac{1}{2}$ "	2/pk
PAP-CF1006	Respironics REMStar Pro, REMStar Plus Ultrafine	3 $\frac{1}{2}$ " x 1 $\frac{1}{2}$ "	2/pk
PAP-CF1006F	Respironics REMStar Pro, REMStar Plus Foam	3 $\frac{1}{2}$ " x 1 $\frac{1}{2}$ "	2/pk
PAP-CF1007	Respironics M-Series Ultrafine	1 $\frac{1}{4}$ " x $\frac{3}{8}$ "	6/pk
PAP-CF1007F	Respironics M-Series Foam	1 $\frac{1}{8}$ " x $\frac{3}{8}$ "	2/pk
PAP-CF2104/-50	ResMed Auto Set T Disposable	4 $\frac{1}{4}$ " x 3 $\frac{1}{4}$ "	3/pk or 50/pk
PAP-CF2105/-50	ResMed S8 Series Disposable	1 $\frac{1}{8}$ " x 1 $\frac{1}{8}$ "	3/pk or 50/pk
PAP-CF-2105HA/-50	ResMed S8 Series Hypoallergenic	1 $\frac{1}{8}$ " x 1 $\frac{1}{8}$ "	3/pk or 50/pk
PAP-CF2106/-50	ResMed Adapt SV Disposable	1 $\frac{1}{4}$ " x 1 $\frac{1}{2}$ "	3/pk or 50/pk

PAP-CF2107/-50	ResMed S9 Series Disposable	2 $\frac{1}{4}$ " x 1 $\frac{1}{8}$ "	3/pk or 50/pk
PAP-CF-2107HA/-50	ResMed S9 Series Hypoallergenic	2 $\frac{1}{4}$ " x 1 $\frac{1}{8}$ "	3/pk or 50/pk
PAP-CF4001	Fisher&Paykel HC200 - HC221	5" x $\frac{1}{4}$ "	4/pk
PAP-CF4002	Fisher&Paykel HC230 Series, HC600 Series Disposable	2 $\frac{1}{4}$ " x $\frac{3}{8}$ "	4/pk
PAP-CF4003	Fisher&Paykel ICON Series Disposable	2 $\frac{1}{8}$ " x $\frac{1}{2}$ "- $\frac{3}{4}$ "	4/pk
PAP-CF5004	DeVilbiss IntelliPAP Ultrafine	1 $\frac{1}{16}$ " x $\frac{1}{16}$ "	4/pk
PAP-CF5004F	DeVilbiss IntelliPAP Foam	1 $\frac{1}{8}$ " x 1 $\frac{1}{16}$ "	4/pk
PAP-CF6001	Covidien NPB GoodKnight 418 Ultrafine	2 $\frac{1}{4}$ " x 1 $\frac{1}{2}$ "	4/pk
PAP-CF6002	Covidien NPB GoodKnight 418 A/G/P/S Ultrafine	5 $\frac{1}{4}$ " x $\frac{3}{4}$ "	4/pk
PAP-CF6003	Covidien NPB GoodKnight 420/425 Ultrafine	1 $\frac{1}{4}$ " x $\frac{3}{4}$ "	2/pk
PAP-CF6003F	Covidien NPB GoodKnight 420/425 Foam	1 $\frac{1}{8}$ " x $\frac{3}{8}$ "	Each
PAP-CF6004F	Covidien NPB Knightstar 320/330 Foam	4 $\frac{1}{8}$ " x 2"	Each
PAP-CF6005	Covidien NPB Goodnight 314/318 Ultrafine	6" x 1 $\frac{1}{2}$ "	2/pk
PAP-CF6005F	Covidien NPB Goodnight 314/318 Foam	6 $\frac{1}{4}$ " x 1"	2/pk
PAP-CF6007	Covidien NPB Sandman Ultrafine	2 $\frac{1}{8}$ " x 1 $\frac{1}{8}$ "	6/pk
PAP-CF6007F	Covidien NPB Sandman Foam	2 $\frac{1}{8}$ " x 1 $\frac{1}{8}$ "	2/pk
PAP-CF7001	Breas PV 1 Ultrafine	2 $\frac{1}{2}$ " x 1 $\frac{1}{4}$ "	2/pk

RESPIRATORY PRODUCTS

Nebulizer



RNE3653MX



RNE6910P-DR



R-50012

Item #	Description	M.S.R.P	Sugg. HCPCS
RNE3653MX	Nebulizer	\$139	E0570
RNE6910P-DR	Portable Nebulizer	\$249	E0570
R-50012	Heavy duty, 50 PSI Compressor	\$695	E0565

Nebulizer Accessories



R-WM0254



R-WM0210



R-WM0250



R-WM0251



R-WM0360



RNE-BR300-1



R-M10-1 Medium



R-M20-1 Large

Item #	Description	Pkg
R-WM0254	Nebulizer Kit, Reusable	10/cs
R-WM0210	Nebulizer Replacement Kit	50/cs
R-WM0250	Adult Aerosol Mask	50/cs
R-WM0251	Pediatric Aerosol Mask	50/cs
R-WM0360	Adult Tracheostomy Mask	50/cs
RNE-BR300-1	Rigid Spacer	Each
R-M10-1/ R-M20-1	Adult Spacer Mask (M L)	Each

Suction Devices



Item #	Description	M.S.R.P	Sugg. HCPCS
ASP800	Stat. Aspirator without Canister	\$259	E0600
R-605	Portable Aspirator	\$495	E0600



Nebulizer Filter



RNE3651-FILT



RNE5650D-601



RNE3655D-602



RNE3652-FILT



RNE-BF015



RNE-BF016



RNE-BF019



RNE-BF021

Item #	Description	Pkg
RNE3651-FILT	Round Felt	Each
RNE5650D-601	Filter	25/pk
RNE3655D-602	Filter	25/pk
RNE3652-FILT	Round Foam	Each
RNE-SSBF015	Plastic Intake Filter	10/pk
RNE-SSBF016	Plastic Intake Filter with Head	10/pk
RNE-SSBF019	Foam Filter	10/pk
RNE-SSBF021	Foam Filter	10/pk
RNEC21V-FILT-5	Filter for Omron C-21	5/pk

Suction Device Accessories



ASP-T-12-1



ASP-613



ASP-AG615725



ASP-AG615473



ASP-AG615730



ASP-610-1



ASP-MSUF-01



ASP-SSRES026



ASP-AG-Q32001



ASP-SSRES021



ASP-SSRES022



ASP-U601CNHOLD

Item #	Description	Pkg
ASP-T12-1	7" x 0.312" Tubing	Each
ASP-613	6' Tubing Male-Female	Each
ASP-AG615725	6' Patient Tubing	Each
ASP-AG615473	16" Patient Tubing	Each
ASP-AG615730	4" Tubing Connection	6/pk
ASP-610-1	Suction Canister 800cc	Each
ASP-MSUF-01	Final Bacteria Filter	Each
ASP-SSRES026	Suction Kit - Canister, Tubing, Filter	Each
ASP-AG-Q32001	Yankauer Suction Catheter	Each
ASP-SSRES021	Swivel Elbow Connector with Suction Port	10/pk
ASP-SSRES022	Swivel Elbow Connector	10/pk

RESPIRATORY PRODUCTS

iFill® Oxygen Fill System

- » Fills iFill proprietary cylinder sizes: M4, M6, C, D, & E
- » Easily tops off partially-filled cylinders
- » Automatically shuts off when filling is complete
- » Simple 3-step operation



Item #	Description	M.S.R.P	Sugg. HCPCS
R-535D-M6-PD-PKG	iFill Oxygen Station PKG with 2 pulse dose, iFill cylinder & carrying case	\$6,000	K0738

Oxygen Concentrator

- » 5 liter
- » Lightweight compact design (36 lbs.)
- » Oxygen sensing device standard on every unit
- » Noticeably quiet operation
- » Lockable flow meter



Item #	Description	M.S.R.P	Sugg. HCPCS
R-525DS	5L Oxygen Concentrator	\$2,000	E1390

iGO® 3 Liter Portable

- » Lightweight portable
- » Weighs only 15.5 lbs (without battery)
- » Dimension (HxWxD) 15" x 12.3" x 7.1"
- » MAX. recommended continuous flow: 3 LPM
- » Sound level: 40 dBA
- » Carry case-wheeled - Sugg. HCPCS: E1354



Item #	Description	M.S.R.P	Sugg. HCPCS
R-306DS-A	iGo Portable Oxygen System	\$3,950	E1390, E1392

Oxygen Conserving Devices

- » Conserving mode provide 3:1 oxygen savings
- » Conforms to the patients natural breathing cycle
- » Eliminates oxygen waste



R-C2000D



R-CTOX-MN01

Item #	Description	M.S.R.P	Sugg. HCPCS
R-CTOX-MN01	Single	\$395	E1399
R-C2000D	Dual	\$299	E1399

Oxygen Cart



R-CART-2

Item #	Description	M.S.R.P
R-CART-2	Portable oxygen cart	\$45

Oxygen Cylinders



R-CYL-M6



R-CYL-M9



R-CYL-ME

Item #	Valve	Description	Liters	M.S.R.P
R-CYL-M6	Post	B Cylinder	164	\$75
R-CYL-M9	Post	C Cylinder	248	\$89
R-CYL-ME	Post	E Cylinder	680	\$135

RESPIRATORY PRODUCTS

Regulator

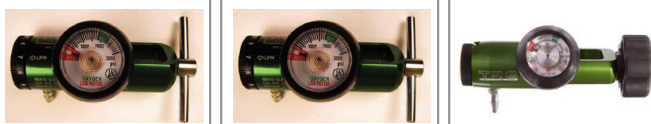

R-3708

R-3715

R-18040U

Item #	Description	M.S.R.P
R-3703	Oxygen Regulator 0-3 L/Min	\$89
R-3708	Oxygen Regulator 0-8 L/Min	\$89
R-3715	Oxygen Regulator 0-15 L/Min	\$89
R-18040U	Pediatric Regulator (Fractional)	\$269

Pulse Oximeter



R-MD300C2A



R-MD300C1C-PCH

Item #	Description	M.S.R.P
R-MD300C2A	Finger Pulse Oximeter	\$295
R-MD300C1C-PCH	Finger Pulse Oximeter Pouch	\$15

Cylinder Wrench



R-WM0700



R-WM0704

Item #	Description	Pkg
R-6004	Cylinder Wrench without Chain	25/cs
R-WM0700	Cylinder Wrench without Chain	50/cs
R-WM0704	Cylinder Wrench with Chain	50/cs

Cylinder Carrying Bags



R-O2BAGME+9



R-O2BAGM6

Item #	Description	M.S.R.P
R-O2BAGME+9	Wheelchair Carrier for M9, E Cylinders	\$69
R-O2BAGM6	Shoulder Bag for E, M6 Cylinders	\$59

Oxygen Concentrator Castors



R-CAST2P



R-CAST501IVC



R-CAST590PB

Item #	Description
R-CAST2P	Use for LX
R-CAST501IVC	Use for 301, 501 & 5LX
R-CAST590PB	Use for PB590

Concentrator Switches, Hour Meter & Cooling Fans



R-PSW-790U



R-PSW1134IVC



R-PSW-508DEV



R-505HM-IVC



R-505HM-UNI



R-FAN44, Universal

Item #	Description
R-PSW-790U	Power Switch, 110V
R-PSW1134IVC	Power Switch, 110V
R-PSW-508DEV	On/Off Switch
R-505HM-IVC	Hour Meter, 110V, for IVC 301/501
R-505HM-UNI	Hour Meter, 110V, for most concentrators
R-FAN44, Universal	Cooling Fan, 110V

Cleaning Solution

Item #	Description
STERI-FAB	Steri-Fab 1 gal



RESPIRATORY PRODUCTS

Cannula



Item #	Description	Pkg
R-WM0197	Adult Cannula, 7'	50/cs
R-WM0198	Adult Cannula, 14'	50/cs
R-WM0195	Adult Cannula, 25'	25/cs
R-WM0137	Adult Cannula, Micro 7'	15/cs
R-WM0194	Adult Cannula, Comfort Plus 4'	20/cs
R-4147	Adult Dual Port Cannula with 7' Supply Tube	25/cs
R-WM0556	Comfort Soft Cannula with 7' Supply Tube	50/cs
R-WM0566	Comfort Soft Cannula with 14' Supply Tube	50/cs
R-WM0550	Adult Cannula, High Flow with 7' Supply Tube,	25/cs
R-WM0554	Adult Cannula, High Flow with 4' Supply Tube,	25/cs
R-WM0187	Pediatric Cannula - Comfort Soft with 7' Supply Tube	50/cs
R-WM0177	Infant Cannula - Comfort Soft with 7' Supply Tube	50/cs

Oxygen Masks



R-WM0370



R-WM0371



R-SSRES2201



R-SSRES2202

Item #	Description	Unit
R-WM0370	Simple O2 Mask-Adult, with 7' Safety Tubing	50/cs
R-WM0371	Simple O2 Mask-Pediatric, with 7' Safety Tubing	50/cs
R-SSRES2201	Partial Rebreather O2 Mask Pediatric, with 7' Safety Tubing	50/cs
R-SSRES2202	Non-Rebreather Mask Pediatric, with 7' Tubing & Reservoir Bag	50/cs

Respiratory Product Accessories



R-FM-R217P18



R-AG86065



R-R221-P11



R-WM0480



R-AG2000799-25



R-SSRES071



R-WM0221



R-SSRES003

Item #	Description	Unit
R-FM-R217P18	O2 Flow Meter with Tubing	Each
R-AG86065	Washer with Rubber Ring — Brass	50/pk
R-R221-P11	Ultramax O2 Analyzer	Each
R-WM0480	Bubble Humidifier 6 psi	50/cs
R-AG2000799-25	Humidifier Adapter for IVC. Concentrator	25/pk
R-SSRES071	Drainage Bag with Y-Adapter	50/cs
R-WM0221	Water Trap	25/cs
R-SSRES003	Oxygen In Use Signs	50/pk

Tubing



Item #	Description	Units/CS	M.S.R.P	Sugg. HCPCS
R-WM0014	14' Tubing	50	\$4.95/ea	A4616
R-WM0027	25' Tubing	25	\$5.45/ea	A4616
R-WM0052	50' Tubing	20	\$5.99/ea	A4616

RESPIRATORY PRODUCTS

Connectors & Adapters



R-WM0409 / R-6003



R-SSRES002



R-SSRES011



R-WM0043 / R-6001



R-SSRES013



R-SSRES014



R-AG-SH749



R-AG-SH75



R-AG1642



R-AG1016

Item #	Description	Unit
R-WM0409	Christmas Tree Connector — Non-Swivel	50/pk
R-6003	Christmas Tree Connector - Non-Swivel	50/pk
R-SSRES002	Christmas Tree Connector — Swivel	10/pk
R-SSRES011	Tubing Reducer Connector	10/pk
R-WM0043	Tubing Connector, Barbed	50/cs
R-6001	Tubing Connector, Barbed	100/cs
R-SSRES013	Circuit Connector 22 mm OD 15 mm ID x 22 mm OD	10/pk
R-SSRES014	Circuit Connector 22 mm OD x 22 mm OD with Lip	10/pk
R-AG-SH749	Oxygen Tubing Y-Connector	5/pk
R-AG-SH75	Oxygen Tubing Connector — Swivel	10/pk
R-AG1642	O2 Enrichment CPAP Tubing Connector	5/pk
R-AG1016	Ear Cushions for Cannula	Each
R-WM0440	Earmate, Charcoal Gray	50/pk

Oxygen Rack

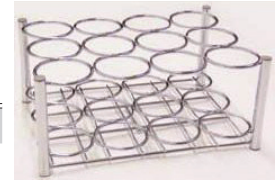

Item #	Description
R-E12-RACK	12 Rack for E Cylinder
R-E6-RACK	6 Rack for E Cylinder

Final Bacteria & HEPA Filters



R-BF316



R-BF516-4



R-BF516TS



R-BF1001



R-BF1438



R-SSBF2222



R-AG-LL201



R-BF5001



R-BF5002



R-BFH6

Item #	Description	Unit
R-BF316	Final Bacteria Filter 3/16 in Barbed	10/pk
R-BF516-4	Final Bacteria Filter 5/16 in Barbed	4/pk
R-BF516TS	Final Bacteria Filter 5/16 in Barbed and Threaded	10/pk
R-BF1001	EverFlo Intake Filter	Each
R-BF1438	Final Bacteria Filter 1/4 in to 3/8 in Barbed	10/pk
R-SSBF2222	Intake Bacteria Filter	5/PK
R-AG-LL201	Extended Life Bacteria Filter Nonthreaded	Each
R-BF5001	Inline HEPA Filter	Each
R-BF5002	Inline HEPA Filter	Each
R-BFH6	6 in HEPA Capsule Threaded	Each

RESPIRATORY PRODUCTS

Oxygen Cabinet Filters

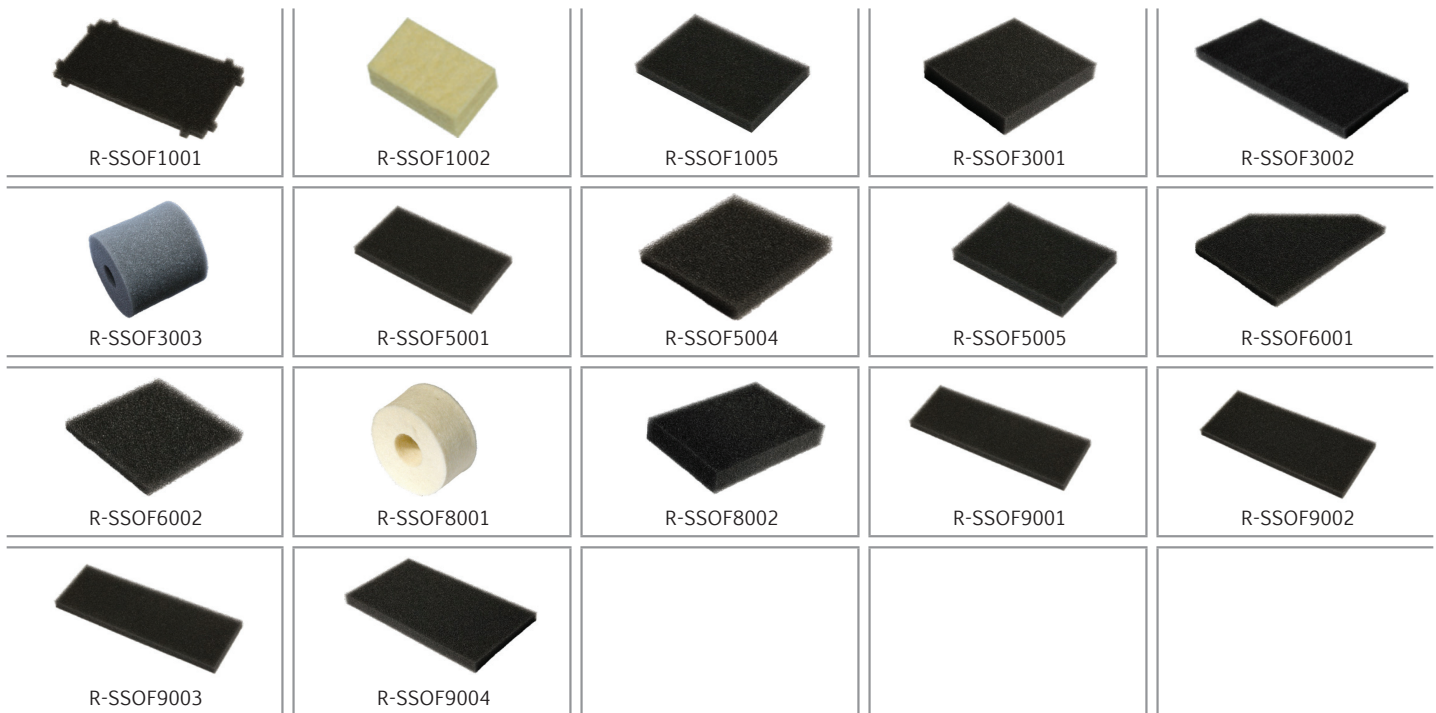

Item #	To Fit	Size	Qty.
R-SSOF1001	Respironics Millenium Foam	8" x 5" x 3/8"	10/pk
R-SSOF1002	Respironics Millenium Felt	N/A	6/pk
R-SSOF1005	Respironics EverGo Foam	3" x 2" x 3/8"	10/pk
R-SSOF3001	Healthydyne BX5000 Foam	6" x 5 1/2" x 3/8"	10/pk
R-SSOF3002	Healthydyne Alliance Foam	8 1/4" x 3 3/4"	10/pk
R-SSOF3003	Intake Filter for use with BF2222 Foam	N/A	10/pk
R-SSOF5001	DeVilbiss MC Foam	6 1/8" x 3 1/2" x 1/4"	10/pk

R-SSOF5004	DeVilbiss Solaris III, 303DS Foam	3 3/4" x 3 3/4" x 1/2"	10/pk
R-SSOF5005	DeVilbiss Solaris V, 505/515 DS Foam	5 5/8" x 3 5/8" x 1/2"	10/pk
R-SSOF6001	Covidien NPB 590 & 592A Foam	6 3/4" x 4 1/2"	10/pk
R-SSOF6002	Covidien NPB 492 & 492A Foam	6" x 5 1/2"	N/A
R-SSOF8001	Airsep Forlife & Newlife series Round Felt	N/A	10/pk
R-SSOF8002	Airsep Newlife, Newlife Elite Foam	5 1/2" x 4 1/2" x 1/2"	10/pk
R-SSOF9001	IVC. Mobilair 3 & 5, IRC 3 & 5 Foam	6 3/4" x 3 3/8" x 1/2"	10/pk

Suction Catheter & Care Trays

14 & 16 Fr. Single Lumen
Steri. Cath. System
Package Includes:
MDI Adapters, Trac-Wedge Device,
Patient Label

R-AGT610014 - 12.65 kit
R-AGT610016 - 12.75 kit

Full Component
Trach Tray
Package Includes:
Force PS, Pipe Cleaner, Two Compartment,
6" Swabstick, Inner Tray, 17"x 19" Towel, 4"x 4"
Gauze, Nitrile Gloves, Tie & Brush

R-AG5960- 5.20 kit

