

# A Food Labeling Guide

Guidance for Industry

---

U.S. Department of Health  
and Human Services

---

Food and Drug Administration

---

Center for Food Safety and Applied Nutrition

---

---

---

---

---

---

---

---

---

---

---

---

---

January 2013



**Additional copies are available from:**

---

Office of Nutrition, Labeling, and Dietary Supplements  
HFS-800  
Center for Food Safety and Applied Nutrition  
Food and Drug Administration  
5100 Paint Branch Parkway  
College Park, MD 20740  
(Tel) 240-402-2373

*[www.fda.gov/FoodLabelingGuide](http://www.fda.gov/FoodLabelingGuide)*

# TABLE OF CONTENTS

## **Contains Nonbinding Recommendations**

### **Guidance for Industry A Food Labeling Guide**

*This guidance represents the Food and Drug Administration's (FDA's) current thinking on this topic. It does not create or confer any rights for or on any person and does not operate to bind FDA or the public. You can use an alternative approach if the approach satisfies the requirements of the applicable statutes and regulations. If you want to discuss an alternative approach, contact the FDA staff responsible for implementing this guidance. If you cannot identify the appropriate FDA staff, call the appropriate telephone number listed on the title page of this guidance.*

<b>1. INTRODUCTION</b>	<b>4</b>
<b>2. BACKGROUND</b>	<b>4</b>
<b>3. GENERAL FOOD LABELING REQUIREMENTS</b>	<b>5</b>
<b>4. NAME OF FOOD</b> Juices	<b>7</b>
<b>5. NET QUANTITY OF CONTENTS STATEMENTS</b>	<b>14</b>
<b>6. INGREDIENT LISTS</b> Colors Food Allergen Labeling	<b>17</b>
<b>7. NUTRITION LABELING</b> General Nutrient Declaration Products with Separately Packaged Ingredients/Assortments of Foods Label Formats/Graphics General Specific Label Formats Trans Fat Labeling Miscellaneous Serving Size Exemptions/Special Labeling Provisions	<b>25</b>
<b>8. CLAIMS</b> Nutrient Content Claims Health Claims Qualified Health Claims Structure/Function Claims	<b>72</b>
<b>9. APPENDIX A: DEFINITIONS OF NUTRIENT CONTENT CLAIMS</b>	<b>87</b>
<b>10. APPENDIX B: ADDITIONAL REQUIREMENTS FOR NUTRIENT CONTENT CLAIMS</b>	<b>91</b>
<b>11. APPENDIX C: HEALTH CLAIMS</b>	<b>95</b>
<b>12. APPENDIX D: QUALIFIED HEALTH CLAIMS</b>	<b>105</b>
<b>13. APPENDIX E: ADDITIONAL FDA RESOURCES</b>	<b>126</b>
<b>14. APPENDIX F: CALCULATE THE PERCENT DAILY VALUE (DV) FOR THE APPROPRIATE NUTRIENTS</b>	<b>127</b>
<b>15. APPENDIX G: DAILY VALUES FOR INFANTS, CHILDREN LESS THAN 4 YEARS OF AGE, AND PREGNANT AND LACTATING WOMEN</b>	<b>128</b>
<b>16. APPENDIX H: ROUNDING THE VALUES ACCORDING TO THE FDA ROUNDING RULES</b>	<b>129</b>

## 1. INTRODUCTION

In a guide such as this, it is impractical to attempt to answer every food labeling question that might arise. The most frequently raised questions have been addressed using a “question and answer” format. We believe the vast majority of food labeling questions are answered. They are grouped by the food labeling area of interest. The Table of Contents will help you locate your food labeling area of interest.

Under FDA's laws and regulations, FDA does not pre-approve labels for food products. Questions concerning the labeling of food products may be directed to the Food Labeling and Standards Staff (HFS-820), Office of Nutrition, Labeling, and Dietary Supplements, Center for Food Safety and Applied Nutrition, Food and Drug Administration, 5100 Paint Branch Parkway, College Park, MD 20740-3835, Telephone: (240) 402-2371.

## 2. BACKGROUND

The Food and Drug Administration (FDA) is responsible for assuring that foods sold in the United States are safe, wholesome and properly labeled. This applies to foods produced domestically, as well as foods from foreign countries. The Federal Food, Drug, and Cosmetic Act (FD&C Act) and the Fair Packaging and Labeling Act are the Federal laws governing food products under FDA's jurisdiction.

The FDA receives many questions from manufacturers, distributors, and importers about the proper labeling of their food products. This guidance is a summary of the required statements that must appear on food labels under these laws and their regulations. To help minimize legal action and delays, it is recommended that manufacturers and importers become fully informed about the applicable laws and regulations before offering foods for distribution in the United States.

The Nutrition Labeling and Education Act (NLEA), which amended the FD&C Act requires most foods to bear nutrition labeling and requires food labels that bear nutrient content claims and certain health messages to comply with specific requirements. Although final regulations have been established and are reflected in this guidance, regulations are frequently changed. It is the responsibility for the food industry to remain current with the legal requirements for food labeling. All new regulations are published in the Federal Register (FR) prior to their effective date and compiled annually in Title 21 of the Code of Federal Regulations (CFR).

This guidance has been prepared by the Office of Nutrition, Labeling, and Dietary Supplements in the Center for Food Safety and Applied Nutrition at the U.S. Food and Drug Administration.

**This document supercedes the previous version issued in October 2009.**



### 3. GENERAL FOOD LABELING REQUIREMENTS

#### 1. Where should label statements be placed on containers and packages?

**Answer:** There are two ways to label packages and containers:

- a. Place all required label statements on the front label panel (the principal display panel or PDP), or,
- b. Place certain specified label statements on the PDP and other labeling on the information panel (the label panel immediately to the right of the PDP, as seen by the consumer facing the product).

*21 CFR 101.1, 21 CFR 101.2, 21 CFR 101.3, 21 CFR 101.4, 21 CFR 101.5, 21 CFR 101.9, and 21 CFR 101.105*

#### 2. What are the PDP and the alternate PDP?

**Answer:** The PDP, is that portion of the package label that is most likely to be seen by the consumer at the time of purchase. Many containers are designed with two or more different surfaces that are suitable for display as the PDP. These are alternate PDPs. *21 CFR 101.1*

#### 3. What label statements must appear on the PDP?

**Answer:** Place the statement of identity, or name of the food, and the net quantity statement, or amount of product, on the PDP and on the alternate PDP. The required type size and prominence are discussed in sections 4 and 5 of this guidance. *21 CFR 101.3(a) and 21 CFR 101.105(a)*

#### 4. Which label panel is the information panel?

**Answer:** The information panel is the label panel immediately to the right of the PDP, as displayed to the consumer. If this panel is not usable, due to package design and construction, (e.g., folded flaps), then the information panel is the next label panel immediately to the right. *21 CFR 101.2(a)*

STATEMENT OF IDENTITY



PDP



NET QUANTITY STATEMENT

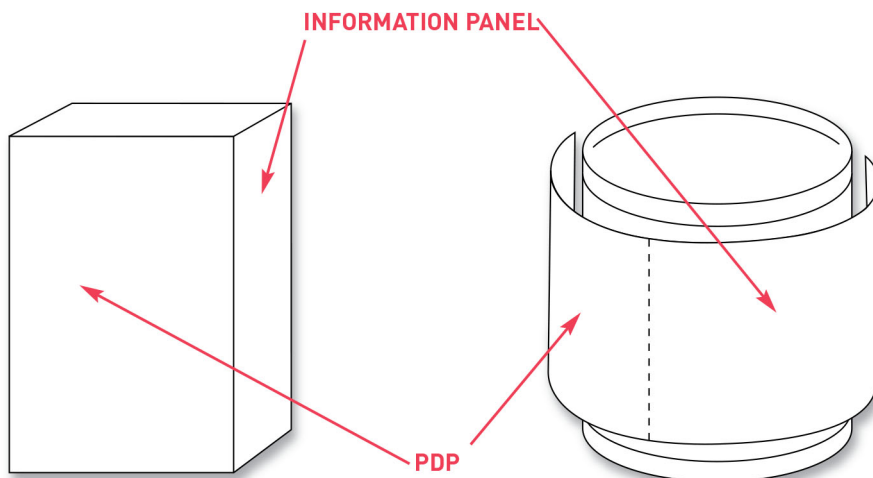

## 5. What is information panel labeling?

**Answer:** The phrase “information panel labeling” refers to the label statements that are generally required to be placed together, without any intervening material, on the information panel, if such labeling does not appear on the PDP. These label statements include the name and address of the manufacturer, packer or distributor, the ingredient list, nutrition labeling and any required allergy labeling. *21 CFR 101.2(b) and (d), Section 403(w) of the FD&C Act*

## 6. What type size, prominence and conspicuousness is required?

**Answer:** For information panel labeling, use a print or type size that is prominent, conspicuous and easy to read. Use letters that are at least one-sixteenth (1/16) inch in height based on the lower case letter “o”. The letters must not be more than three times as high as they are wide, and the lettering must contrast sufficiently with the background so as to be easy to read. Do not crowd required labeling with artwork or non-required labeling.

Smaller type sizes may be used for information panel labeling on very small food packages as discussed in *21 CFR 101.2(c) & (f)*.

Different type sizes are specified for the Nutrition Facts label. (see section 7)

The type size requirements for the statement of identity and the net quantity statement are discussed in sections 4 and 5 of this guidance.

*21 CFR 101.2(c)*

## 7. What is the prohibition against intervening material?

**Answer:** Information that is not required by FDA is considered intervening material and is not permitted to be placed between the required labeling on the information panel (e.g., the UPC bar code is not FDA required labeling). *21 CFR 101.2(e)*

## 8. What name and address must be listed on the label?

**Answer:** Food labels must list:

- a. Name and address of the manufacturer, packer or distributor. Unless the name given is the actual manufacturer, it must be accompanied by a qualifying phrase which states the firm's relation to the product (e.g., “manufactured for” or “distributed by”);
- b. Street address if the firm name and address are not listed in a current city directory or telephone book;
- c. City or town;
- d. State (or country, if outside the United States); and
- e. ZIP code (or mailing code used in countries other than the United States).

*21 CFR 101.5*

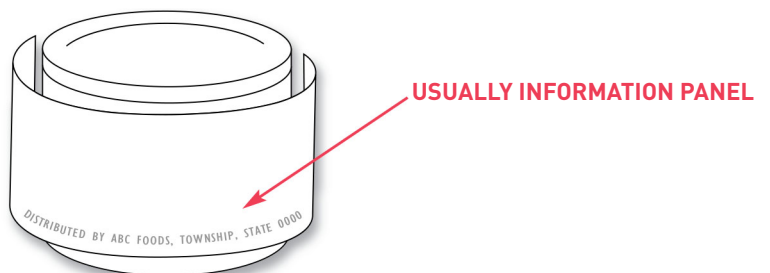
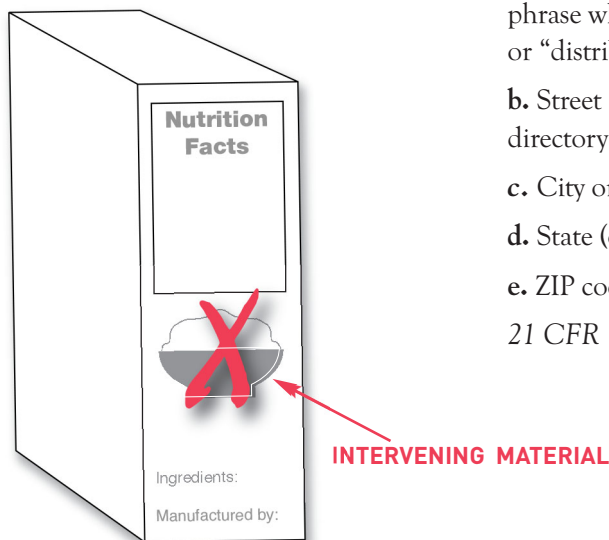
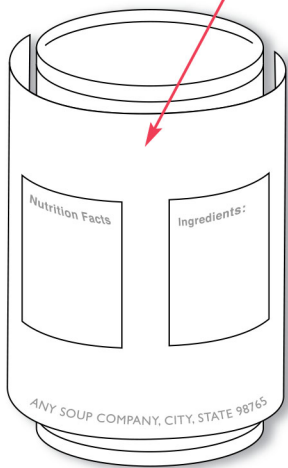
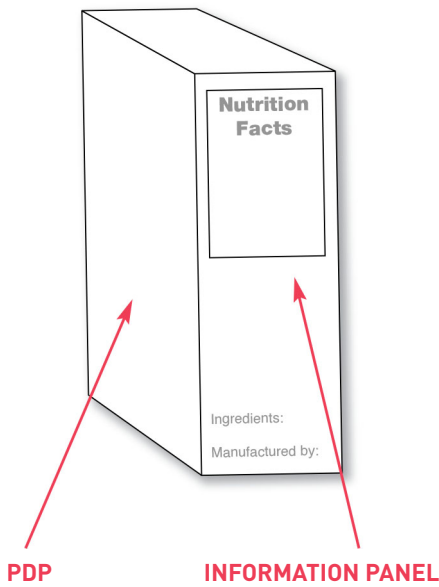

## 4. NAME OF FOOD

### 1. What is the name of the food statement called and where must it be placed?

**Answer:** The statement of identity is the name of the food. It must appear on the front label, or PDP as well as any alternate PDP. 21 CFR 101.3

### 2. Should the statement of identity stand out?

**Answer:** Use prominent print or type for the statement of identity. It shall be in bold type. The type size must be reasonably related to the most prominent printed matter on the front panel and should be one of the most important features on the PDP. Generally, this is considered to be at least 1/2 the size of the largest print on the label. 21 CFR 101.3(d)

### 3. What name should be used as the statement of identity?

**Answer:** The name established by law or regulation, or in the absence thereof, the common or usual name of the food, if the food has one, should be used as the statement of identity. If there is none, then an appropriate descriptive name, that is not misleading, should be used. Brand names are not considered to be statements of identity and should not be unduly prominent compared to the statement of identity. 21 CFR 101.3(b) & (d)

### 4. Where should the statement of identity be placed on the label?

**Answer:** Place the statement of identity on the PDP in lines generally parallel to the base of the package. 21 CFR 101.3(d)

### 5. When are fanciful names permitted as the statement of identity?

**Answer:** When the nature of the food is obvious, a fanciful name commonly used and understood by the public may be used. 21 CFR 101.3(b)(3)

### 6. Is it necessary to use the common or usual name instead of a new name?

**Answer:** The common or usual name must be used for a food if it has one. It would be considered misleading to label a food that has an established name with a new name. If the food is subject to a standard of identity it must bear the name specified in the standard. 21 CFR 101.3(b)(2)

### 7. Should modified statements of identity be used for sliced and unsliced versions of a food?

**Answer:** Labels must describe the form of the food in the package if the food is sold in different optional forms such as sliced and unsliced, whole or halves, etc. 21 CFR 101.3(c)

### 8. What food must be labeled as an "imitation"?

**Answer:** Generally a new food that resembles a traditional food and is a substitute for the traditional food must be labeled as an imitation if the new food contains less protein or a lesser amount of any essential vitamin or mineral. 21 CFR 101.3(e)

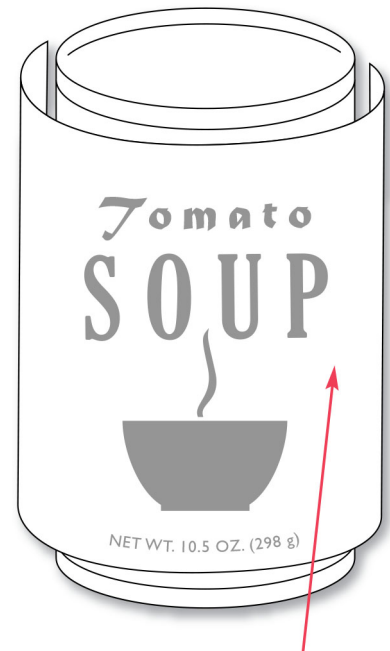

STATEMENT OF IDENTITY

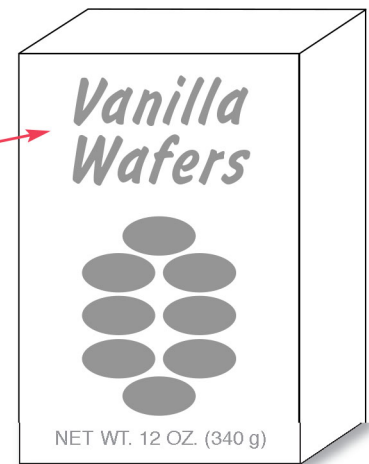

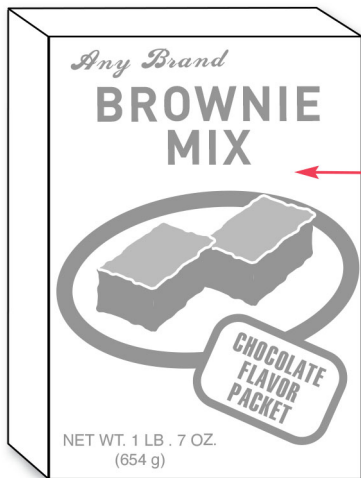

**9. What type size and degree of prominence is required for the word “imitation” in the product name?**

*Answer:* Use the same type size and prominence for the word “imitation” as is used for the name of the product imitated. 21 CFR 101.3(e)

**10. Are there restrictions on label artwork?**

*Answer:* Do not use artwork that hides or detracts from the prominence and visibility of required label statements or that misrepresents the food. 21 CFR 1.21(a)(1), 21 CFR 101.3(a), 21 CFR 101.105(h)

**11. Where should the country of origin be declared on an imported food?**

*Answer:* The country of origin statement must be conspicuous. If a domestic firm's name and address is declared as the firm responsible for distributing the product, then the country of origin statement must appear in close proximity to the name and address and be at least comparable in size of lettering. (FDA/CBP (Customs and Border Protection) Guidance and Customs regulation 19 CFR 134)

**12. Are foreign language labels permitted?**

*Answer:* If a foreign language is used anywhere on the label, all required label statements must appear both in English and in the foreign language. 21 CFR 101.15(c)(2)

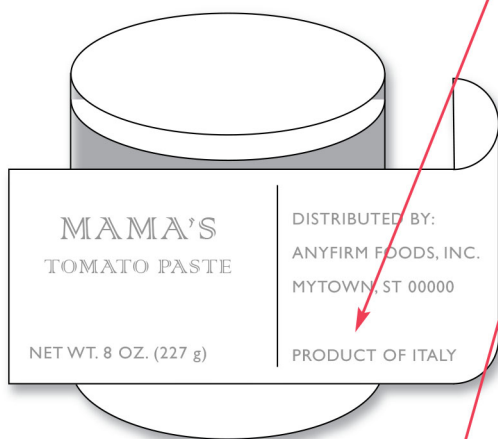

**Juices**

**J1. What causes a juice beverage label to be required to have a % juice declaration?**

*Answer:* Beverages that purport to contain juice (fruit or vegetable juice) must declare the % of juice. Included are beverages that purport to contain juice by way of label statements, by pictures of fruits or vegetables on the label, or by taste and appearance causing the consumer to expect juice in the beverage. This includes non-carbonated and carbonated beverages, full-strength (100%) juices, concentrated juices, diluted juices, and beverages that purport to contain juice but contain no juice. 21 CFR 101.30(a)

**J2. Where and how is % juice declared?**

*Answer:* The % juice must be on the information panel (for packages with information panels), near the top. Only the brand name, product name, logo, or universal product code may be placed above it. Use easily legible boldface print or type that distinctly contrasts with the other printed or graphic material. The type size for the % juice declaration must be not less than the largest type on the information panel, except that used for the brand name, product name, logo, universal product code, or the title phrase Nutrition Facts. The percentage juice declaration may be either “contains \_\_\_\_% juice” or “\_\_\_\_% juice.” The name of the fruit or vegetable may also be included (e.g., “100% Apple Juice”). If the package does not contain an information panel, the percent juice must be placed on the PDP in a type size not less than that required for the net contents declaration and placed near the name of the food. 21 CFR 101.30(e); 21 CFR 101.30(g)



### **J3. Are there any exceptions from the % juice requirement?**

**Answer:** An exception is that beverages containing minor amounts of juice for flavoring are not required to bear a % juice declaration provided that: (a) the product is described using the term “flavor” or “flavored,” (b) the term “juice” is not used other than in the ingredient list, and (c) the beverages do not otherwise give the impression they contain juice such as with the use of explicit vignettes on the label or physical resemblance of the beverage to juice such as pulp. 21 CFR 101.30(c)

### **J4. How is the % juice calculated?**

**Answer:** For juice expressed directly from fruit or vegetables: Compute on a volume/volume basis.

For juice made by adding water to concentrate: Calculate using values from the Brix table in 21 CFR 101.30(h)(1) as the basis for 100% juice. 21 CFR 101.30(j), 21 CFR 101.30(h)

### **J5. Should my product be labeled as a “drink” or a “beverage?”**

**Answer:** Beverages that are 100% juice may be called “juice.” However, beverages that are diluted to less than 100% juice must have the word “juice” qualified with a term such as “beverage,” “drink,” or “cocktail.” Alternatively, the product may be labeled with a name using the form “diluted \_\_\_ juice,” (e.g. “diluted apple juice”). 21 CFR 102.33(a)

### **J6. Is it necessary to use the term “concentrate” on the label?**

**Answer:** Juices made from concentrate must be labeled with terms such as “from concentrate,” or “reconstituted” as part of the name wherever it appears on the label. An exception is that, in the ingredient statement, the juice is declared as “concentrated \_\_\_ juice and water” or “water and concentrated \_\_\_ juice,” as appropriate. 21 CFR 102.33(g)

### **J7. What statement of identity is used on a mixed fruit or vegetable juice beverage?**

**Answer:** When stated, names of juices must be in descending order of predominance by volume, unless the label indicates that the named juice is used as a flavor. Examples:

- “Apple, Pear and Raspberry Juice Drink”
- “Raspberry-Flavored Apple and Pear Juice Drink”

If the label represents one or more but not all the juices (except in the ingredient list), then the name must indicate that more juices are present. Examples:

- “Apple Juice Blend”
- “Apple Juice in a Blend of Two Other Fruit Juices”

When one or more, but not all, juices are named and the named juice is not the predominant juice, the name of the beverage must either state that the beverage is flavored with the named juice or declare the amount of the named juice in a 5% range. Examples (for a “raspcranberry” beverage that is primarily white grape juice with raspberry and cranberry juices added):

- “Raspcranberry Raspberry and Cranberry flavored Juice Drink”
- “Raspcranberry Cranberry and Raspberry Juice Beverage”
- “10-15% Cranberry Juice and 3-8% Raspberry Juice”

21 CFR 102.33(b), 21 CFR 102.33(c), 21 CFR 102.33(d)

**J8. What type sizes must be used in naming juices?**

*Answer:* The term “from concentrate” or “reconstituted” must be no smaller than one-half the height of the letters in the name of the juice. The 5% range information generally should be not less than one-half the height of the largest type appearing in the common or usual name (may not be less than 1/16th inch in height on packages with 5 sq. in. or less area on the PDP, and not less than 1/8 inch in height on packages with a PDP greater than 5 sq. in.).  
21 CFR 102.5(b)(2), 21 CFR 102.33(d), 21 CFR 102.33(g)

**J9. When does a beverage purport to contain a fruit or vegetable juice?**

*Answer:* Under 21 CFR 101.30(a), a beverage purports to contain fruit or vegetable juice if the product's advertising, label, or labeling, bears the name of, or makes any other direct or indirect representation with respect to any fruit or vegetable juice, or the label or labeling bears any vignette (i.e., depiction of a fruit or vegetable) or another pictorial representation of any fruit or vegetable, or product contains color and flavor that gives the appearance and taste of a fruit or vegetable juice. The beverages may be carbonated or noncarbonated, full strength, diluted, or contain no juice.

**J10. Are bar mixes required to bear percent juice declarations under 21 CFR 101.30?**

*Answer:* Bar mixes are subject to the same requirements as other beverage products. Thus, a percent juice declaration would be required on labels of bar mixes that meet the definition set out in 21 CFR 101.30(a).

**J11. Is a whiskey sour mix that contains lemon juice from concentrate as the only juice component and a number of juice flavors and other ingredients, and that makes no claim or bears no pictures of fruits/fruit juices on the label required to bear a percent juice declaration?**

*Answer:* No. A percent juice declaration would not be required on the whiskey sour mix if the only reference to the lemon juice is in the ingredient statement and no pictures of fruits/fruit juice appear on the label or in its labeling.

**J12. Would a strawberry daiquiri mix have to bear a percent juice declaration?**

*Answer:* A strawberry daiquiri mix would purport to contain strawberries or strawberry juice because the term “strawberry” appears in the identity statement. Also, there is no indication that the strawberry is present only as a flavor or flavoring. If its label or labeling also includes pictures of the juice dripping from strawberries or if the product looks and tastes like it contains strawberry juice or strawberry pulp, the product would have to bear a declaration of the percent of juice or the absence of such juice on the information panel of the label. However, if the product were labeled “Strawberry flavored daiquiri mix” and did not otherwise purport to contain strawberry juice, it would not need a percent juice declaration.

**J13. Must bloody mary mix bear a percent juice declaration?**

*Answer:* Bloody mary mix, by appearance and taste, purports to contain tomato juice and thus would be required to bear a statement as to the percentage of juice contained in the product.



**J14. Would a beverage that is made by reconstituting a blend of dehydrated fruits or vegetables be required to bear a percent juice declaration? If so, how is the percentage determined?**

*Answer:* The declaration is required if the product purports to contain juice. However, because FDA has not established specific procedures for calculating the percentage of juice when beverages are prepared by rehydrating juice solids, it will evaluate labels of products made by this process on a case by case basis. Brix values, where provided in 21 CFR 101.30(h), may be used as guidelines in calculating the level of total juice solids necessary to prepare full strength juices, provided the beverage does not contain other non-juice ingredients.

**J15. Do lemon and lime juices, used for mixed drinks, have to bear a percent juice declaration?**

*Answer:* Yes. The percentage juice declaration would be based on the anhydrous citric acid content of the lemon juice or lime juice, listed in 21 CFR 101.30(h)(1).

**J16. Is apple cider required to bear a percent juice declaration?**

*Answer:* Apple cider is juice that is expressed from apples and must bear a declaration of the percent of juice.

**J17. Does apple cider vinegar have to bear a percent juice declaration?**

*Answer:* No. Apple cider vinegar does not purport to be a beverage and thus is not required to bear a percent juice declaration. Although the product is made from apple juice, it is not considered to be a juice beverage.

**J18. Must concentrated juices bear percent declarations? If so what percentage is to be declared?**

*Answer:* Concentrated juice products must bear a percentage juice declaration and that declaration may not be greater than 100 percent. The label may explain that when the product is diluted according to label directions, the product yields a “\_\_\_percent juice from concentrate,” with the blank being filled in with the correct percentage based on the Brix values set out in 21 CFR 101.30(h)(1), as applicable.

**J19. Is there an exemption from the requirement that the percent juice declaration be on the information panel for multi-unit packages that are packed in a secure shrink wrap and are not for sale by individual unit, and the percentage of juice is declared on the outer shrink wrap?**

*Answer:* No, there is no specific exemption from the requirement that the percent juice declaration be on the information panel of individual juice packages packed in a multi-unit shrink wrap pack.

**J20. Must the entire common or usual name of a juice beverage be in one place and in a single type size? Some juice beverages will have very complex common or usual names, like “cranberry-raspberry flavored juice drink in a blend of three other juices from concentrate.”**

*Answer:* The entire common or usual name must be in one place. If some or all of the juices listed in the name are from concentrate, the term “from concentrate” must follow the names and may be in a smaller type size, but not less than one half the height of the letters in the other part of the common or usual name.  
21 CFR 102.33

**J21. Regarding vignettes on juice labels, do the pictures have to be proportional to the fruits in the juice? Does any fruit that is present at a level of less than 2 percent by volume have to be depicted in the vignette?**

*Answer:* FDA has not established specific requirements for vignettes on labels of juice beverages. FDA urges manufacturers to use vignettes that accurately depict each fruit or vegetable contained in the multiple juice products. However, a vignette depicting only some of the fruits or vegetables may not be considered misleading, if the name of the food adequately and appropriately describes the contribution of the pictured juice. For example, a 100 percent juice consisting of apple, grape and raspberry juices, in which raspberry juice provides the characterizing flavor, and bears a vignette that only depicts raspberries, would not necessarily be misleading if the identity statement were “raspberry juice blended with apple and grape juices.” Alternatively, the statement of identity may be “raspberry flavored fruit juice blend” or “raspberry juice in a blend of two other juices, 3 to 8 percent raspberry juice” (58 FR 2897 at 2921).

**J22. Do I make any adjustments to the analytical Brix value in declaring the percentage of juice when tomato juice contains added salt or other dry ingredients (e.g., spices)?**

*Answer:* Yes. The soluble solids content for tomato juice must be determined before addition of any spices. The soluble solids for tomato juice, determined by refractometer, should be corrected for salt content as prescribed in 21 CFR 156.3(b) and (c).

**J23. I have a 100% juice drink and add a non juice ingredient. May I still call it 100% juice?**

*Answer:* If the added ingredient does not dilute the juice or, for an expressed juice, change its volume, you may continue to call it 100% juice but the percent juice statement must identify the added ingredient, e.g., “100% juice with added preservative.” 21 CFR 101.30(b)(3) and 101.54(e)

**J24. What if the added substance is also a nutrient such as Vitamin C (ascorbic acid)?**

*Answer:* If ascorbic acid is added at levels consistent with fortification of the juice, a declaration as part of the percent juice statement would constitute a nutrient content claim which would trigger compliance with more claims including the required accompanying information. If it were added at the level used as a preservative, then a statement such as 100% juice with preservative could be used. In this case it would be listed in the ingredient statement as a preservative in accordance with 101.22(j).

**J25. Do I have to say “fruit punch from concentrate” or “lemonade from concentrate”?**

*Answer:* No. Section 102.33(g) states that if one or more of the juices in a juice beverage is made from concentrate, then the name of the juice must include the term “from concentrate” or “reconstituted.” Because the names “fruit punch” and “lemonade” do not include the name of a specific juice, these names do not have to contain the term “from concentrate” or “reconstituted.”



**J26. Is the declaration on a lemonade made in terms of the lemon juice only, exclusive of sugar?**

*Answer:* Yes, before adding sugar.

**J27. We have a juice product for food service only, and we are exempt from nutrition labeling for this product (we know that is never goes to club stores). Are we also exempt from percent juice declarations?**

*Answer:* No. There are no exemptions from the requirement for label declaration of the percentage of juice on food service containers of juices.

**J28. Is the common or usual name regulation in 21 CFR 102.33 applicable to 100 percent juices or only to diluted juices?**

*Answer:* The regulation is applicable to both.

**J29. We have very small labels, about 7 square inches. How do you name a citrus punch which contains five juices in which three are from concentrate and two are expressed juices, and the expressed juices are not citrus juices nor do their flavors characterize the beverage? Also, what if one of the citrus juices is an expressed juice and is present only in a minor amount, must it be identified by name?**

*Answer:* There are several alternatives. In the first case, the common or usual name may be “a blend of 3 citrus juices from concentrate with \_\_\_\_\_ and \_\_\_\_\_ juices”, the blanks filled in with names of the expressed juices. In the second case, the citrus juice that is not from concentrate should be listed as in the example given above in order of predominance, i.e., a blend of 2 citrus juices from concentrate with \_\_\_\_\_, \_\_\_\_\_, and \_\_\_\_\_ juices, with the third citrus juice listed in one of the blanks, along with the other expressed juices. Alternatively, a name such as “citrus punch” or “citrus flavored punch” may be used as the statement of identity without further identification of the component juices.

**J30. Is it necessary to state that juices are from concentrate when they are contained in a beverage such as punch?**

*Answer:* Yes, sometimes. If the juices are specifically named in the statement of identity, and the juices are from concentrate, their names must be followed by the term “from concentrate” in accordance with 21 CFR 102.33(g). If no reference is made to specific juices in the name of a punch that is made from concentrated juices, the statement of identity does not have to include the term “from concentrate.” However, each of the concentrated juices used in the punch must be declared in order of predominance in the ingredient statement of the label.

**J31. Does a punch have to be made from fruit juice?**

*Answer:* No. FDA does not have a specific definition or standard of identity for punch, or any other requirement that a punch contain fruit juice. A punch may be an artificially flavored beverage, with or without natural flavorings, or it may be made from tea and other ingredients, exclusive of fruit juice. Such products must be clearly distinguished from products which are made from fruit juices or fruit concentrates or purees. Products containing artificial or natural flavors must be labeled in accordance with 21 CFR 101.22.

**J32. In the case of a vegetable juice cocktail that is 100 percent juice, can the name include the term “cocktail”?**

*Answer:* Yes.

## 5. NET QUANTITY OF CONTENTS STATEMENTS

### 1. What is the net quantity of contents and how is it expressed?

**Answer:** The net quantity of contents (net quantity statement) is the statement on the label which provides the amount of food in the container or package. It must be expressed in weight, measure or numeric count. Generally, if the food is solid, semisolid or viscous, it should be expressed in terms of weight. If the food is a liquid it should be expressed in fluid measure (e.g., fl oz).

21 CFR 101.105(a)(b)(c)

### 2. Where is the net quantity of contents statement placed on the label?

**Answer:** The net quantity statement (net quantity of contents) is placed as a distinct item in the bottom 30 percent of the principal display panel, in lines generally parallel with the base of the container. 21 CFR 101.105(e); 21 CFR 101.105(f)

21 CFR 101.105(f)

### 3. Should the net quantity of contents be stated in both grams and ounces?

**Answer:** Food labels printed must show the net contents in both metric (grams, kilograms, milliliters, liters) and U.S. Customary System (ounces, pounds, fluid ounces) terms. The metric statement may be placed either before or after the U. S. Customary statement, or above or below it. Each of the following examples is correct (additional examples appear in the regulations):

- Net wt 1 lb 8 oz (680g)
- Net wt 1 lb 8 oz 680 g
- 500 ml (1 pt 0.9 fl oz)
- Net contents 1 gal (3.79 L)

P.L. 102-329, August 3, 1992; 21 CFR 101.105

### 4. Why is it necessary to calculate the area of the PDP?

**Answer:** The area of the PDP (calculated in square inches or square centimeters) determines the minimum type size that is permitted for the net quantity statement (see next question).

Calculate the area of the PDP as follows. The area of a rectangular or square PDP on a carton is the height multiplied by the width (both in inches or both in centimeters).

To calculate the area of the PDP for a cylindrical container, use 40% of the product of the height by the circumference. 21 CFR 101.1

### 5. What is the minimum type size?

**Answer:** For the net quantity statements, the minimum type size is the smallest type size that is permitted based on the space available for labeling on the PDP. Determine the height of the type by measuring the height of the lower case letter "o" or its equivalent when mixed upper and lower case letters are used, or the height of the upper case letters when only upper case letters are used.

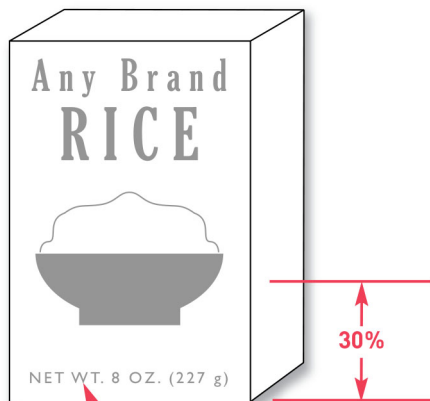

NET QUANTITY STATEMENT

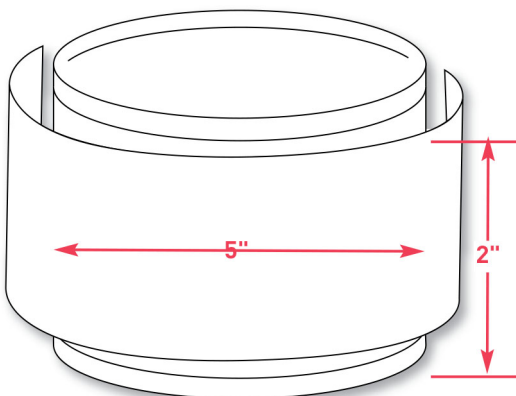
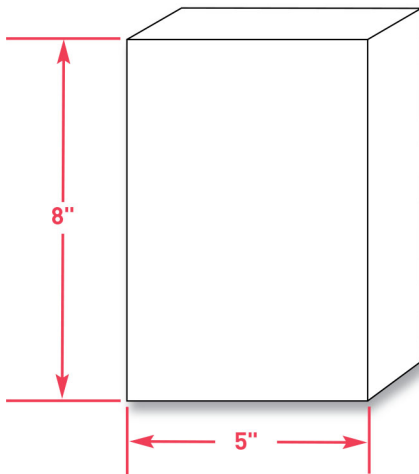

$$10" \times 2" = 20 \text{ SQ. IN.}$$

$$\text{AREA OF PDP} = 20 \text{ SQ. IN.} \times 40\%$$

$$= 8 \text{ SQ. IN.}$$

<i>Minimum Type Size</i>	<i>Area of Principal Display Panel</i>
1/16 in. (1.6 mm)	5 sq. in. (32 sq. cm.) or less
1/8 in. (3.2 mm)	More than 5 sq. in. (32 sq. cm.) but not more than 25 sq. in. (161 sq. cm.)
3/16 in. (4.8 mm)	More than 25 sq. in. (161 sq. cm.) but not more than 100 sq. in. (645 sq. cm.)
1/4 in. (6.4 mm)	More than 100 sq. in. (645 sq. cm.) but not more than 400 sq. in. (2580 sq. cm.)
1/2 in. (12.7 mm)	Over 400 sq. in. (2580 sq. cm.)

21 CFR 101.105(h) and (i)

**6. What are the conspicuousness and prominence requirements for net quantity statements?**

*Answer:* Choose a print style that is prominent, conspicuous and easy to read. The letters must not be more than three times as high as they are wide, and lettering must contrast sufficiently with the background to be easy to read. Do not crowd the net quantity statement with artwork or other labeling (minimum separation requirements are specified in the regulation). 21 CFR 101.105 and 101.15

**7. What is included in the net quantity of contents statement?**

*Answer:* Only the quantity of food in the container or package is stated in the net quantity statement. Do not include the weight of the container, or wrappers and packing materials. To determine the net weight, subtract the average weight of the empty container, lid and any wrappers and packing materials from the average weight of the container when filled with food.

Filled container weighs	18 oz.
Empty container weighs	2 oz.
Wrapper weighs -	1 oz.
<hr/>	
<b>Net Weight</b>	<b>15 oz. (425 g)</b>

21 CFR 101.105(g)

**8. Is water or other packing medium included in determining the net quantity of contents in a food container?**

*Answer:* The water or other liquid added to food in a container is usually included in the net quantity declared on a label.

Beans weigh	9 oz. -
Water weighs	4 oz. -
Sugar weighs	1 oz. -
<hr/>	
<b>Net Weight</b>	<b>14 oz. (396 g)</b>

In some cases where the packing medium is normally discarded, the drained weight is given (e.g., olives and mushrooms).

21 CFR 101.105(a)



NET QUANTITY STATEMENT



**9. What is the net quantity of contents for a pressurized can?**

*Answer:* The net quantity is the weight or volume of the product that will be delivered from the pressurized container together with the weight or volume of the propellant.

Whipped cream -	11.95 oz.
Propellant -	.05 oz.
<hr/>	
<i>Net Weight</i>	<i>12 oz. (340 g)</i>

21 CFR 101.105(g)

**10. What is the policy on using qualifying phrases in net quantity statements?**

*Answer:* Do not use qualifying phrases or terms that exaggerate the amount of food. 21 CFR 101.105(o)

INCORRECT

**Net Wt. = 2 Large oz. (5g)**

CORRECT

**Net Wt. = 2 oz. (5g)**

## 6. INGREDIENT LISTS

### 1. What is the ingredient list?

**Answer:** The ingredient list on a food label is the listing of each ingredient in descending order of predominance.

“INGREDIENTS: Pinto Beans, Water, and Salt”

21 CFR 101.4(a)

### 2. What is meant by the requirement to list ingredients in descending order of predominance by weight?

**Answer:** Listing ingredients in descending order of predominance by weight means that the ingredient that weighs the most is listed first, and the ingredient that weighs the least is listed last (see illustration for question 3 below). 21 CFR 101.4(a)

### 3. Where is the ingredient list placed on the label?

**Answer:** The ingredient list is placed on the same label panel as the name and address of the manufacturer, packer or distributor. This may be either the information panel or the PDP. It may be before or after the nutrition label and the name and address of the manufacturer, packer or distributor.

21 CFR 101.4

See also section 3, question 7 of this guidance for information on intervening material on the information panel.

### 4. What type size is required for ingredient lists?

**Answer:** Use a type size that is at least 1/16 inch in height (based on the lower case “o”) and that is prominent, conspicuous, and easy to read. See the type size, prominence, and clarity requirements for information panel labeling discussed in section 3, question 6 of this guidance. 21 CFR 101.2(c)

### 5. Should water be listed as an ingredient?

**Answer:** Water added in making a food is considered to be an ingredient. The added water must be identified in the list of ingredients and listed in its descending order of predominance by weight. If all water added during processing is subsequently removed by baking or some other means during processing, water need not be declared as an ingredient.

“INGREDIENTS: Water, Navy Beans, and Salt”

21 CFR 101.4(a); 21 CFR 101.4(c); *Compliance Policy Guide* 555.875

### 6. Should the common or usual name always be used for ingredients?

**Answer:** Always list the common or usual name for ingredients unless there is a regulation that provides for a different term. For instance, use the term “sugar” instead of the scientific name “sucrose.”

“INGREDIENTS: Apples, Sugar, Water, and Spices”

See also section 4 question 3. 21 CFR 101.4(a)

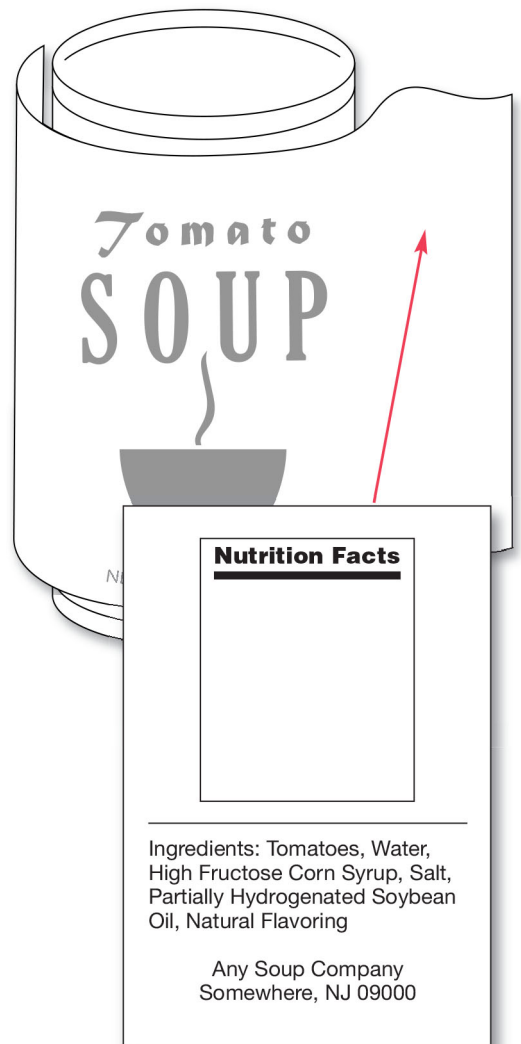

**7. Is it necessary to declare ingredients in “trace”, i.e., incidental amounts? Can sulfites be considered incidental additives?**

*Answer:* FDA does not define “trace amounts”, however, there are some exemptions for declaring ingredients present in “incidental” amounts in a finished food. If an ingredient is present at an incidental level and has no functional or technical effect in the finished product, then it need not be declared on the label. An incidental additive is usually present because it is an ingredient of another ingredient. Note that major food allergens (as discussed on pages 20-24), regardless of whether they are present in the food in trace amounts, must be declared.

Sulfites added to any food or to any ingredient in any food and that has no technical effect in that food are considered to be incidental only if present at less than 10 ppm. *21 CFR 101.100(a)(3) & (4)*

**8. What foods may list alternative fat and oil ingredients?**

*Answer:* Listing alternative fat and oil ingredients (“and/or” labeling) in parentheses following the declaration of fat and oil blends is permitted only in the case of foods in which added fats or oils are not the predominant ingredient and only if the manufacturer is unable to predict which fat or oil ingredient will be used.

“INGREDIENTS: . . . Vegetable Oil (contains one or more of the following: Corn Oil, Soybean Oil, or Safflower Oil) . . .”  
*21 CFR 101.4(b)(14)*

**9. What ingredient listing is necessary for chemical preservatives?**

*Answer:* When an approved chemical preservative is added to a food, the ingredient list must include both the common or usual name of the preservative and the function of the preservative by including terms, such as “preservative,” “to retard spoilage,” “a mold inhibitor,” “to help protect flavor,” or “to promote color retention.”

“INGREDIENTS: Dried Bananas, Sugar, Salt, and Ascorbic Acid to Promote Color Retention”  
*21 CFR 101.22(j)*

**10. How are spices, natural flavors or artificial flavors declared in ingredient lists?**

*Answer:* These may be declared in ingredient lists by using either specific common or usual names or by using the declarations “spices,” “flavor” or “natural flavor,” or “artificial flavor.”

“INGREDIENTS: Apple Slices, Water, Cane Syrup, Corn Syrup, Modified Corn Starch, Spices, Salt, Natural Flavor and Artificial Flavor”

However, products that are spices or spice blends, flavors or colors must list each ingredient by name. *FD&C Act 403(i)(2) and 21 CFR 101.22(h)(1)*

**11. If fruit is canned in juice from concentrate, does the water used to reconstitute the juice have to be declared?**

*Answer:* Yes. The reconstituted juice in which the fruit is canned is prepared from juice concentrate and water, thus both ingredients have to be declared.  
*21 CFR 101.4(a)*

**12. Can juice concentrates be grouped in the ingredient statement (e.g., Fruit Juice Concentrates (grape, apple, cherry))?**

*Answer:* No. “Fruit juice concentrates” is not established as a common or usual name, nor is it established as an appropriate collective name for a variety of different concentrated fruit juices.

**13. When do you declare water as an ingredient in tomato concentrate?**

*Answer:* Water that is added to adjust the Brix level of the standardized food within the permitted range of soluble solids (e.g., water used to adjust a Brix of 28° to 24° in tomato paste, or to adjust a Brix of 16° to 10° in tomato puree) does not have to be declared. However, water added to tomato paste (Brix of 24°) to make a product with a Brix of 16° (tomato puree) would have to be declared. *21 CFR 155.191(a)(3)(iv)*

**14. Can tomato paste, tomato puree, and tomato concentrate be used interchangeably in the ingredient statement?**

*Answer:* Tomato paste and tomato puree are different foods based on the amount of soluble solids present in the product, and thus, the names can not be used interchangeably in the ingredient statement. However, the term “tomato concentrate” may be used in lieu of tomato paste, tomato pulp, or tomato puree when the concentrate complies with the requirements of such foods and the statement “for remanufacturing purposes only” appears on the label of packages equal to or less than 3.1 kilograms or 109 oz. Further, tomato concentrate may be used in lieu of tomato paste, tomato pulp, or tomato puree in the ingredient labeling of catsup. *21 CFR 155.191(a)(3)(i)*, *21 CFR 155.194(a)(3)(ii)(b)*

**15. How do you declare the ingredients in a food when the food itself is made from other foods containing multiple ingredients?**

*Answer:* The sub ingredients of a food that is an ingredient in another food may be declared parenthetically following the name of the ingredient or may be declared by dispersing each ingredient in its order of predominance in the ingredient statement without naming the original ingredient. *21 CFR 101.4(b)(2)*

**16. Do you have to parenthetically declare all of the ingredients in flavors that conform to a standard of identity?**

*Answer:* If the flavor is declared by the standardized name (eg. vanilla extract), each ingredient must also be declared parenthetically following the standardized name. However, the standardized flavor may simply be declared as flavoring, natural flavoring, artificial flavoring, as appropriate. *21 CFR 101.22(i)* and *21 CFR 169*

**17. How do you declare protein hydrolysates that are made of blends of proteins?**

*Answer:* For proteins that are blended prior to being hydrolyzed an appropriate name for the hydrolyzed protein product must be sufficiently descriptive of the protein product and must include all of the various proteins that were used to make the hydrolyzed protein. For example a hydrolyzed protein made from a blend of corn and soy protein would be “hydrolyzed corn and soy protein.” However, if the proteins are hydrolyzed prior to blending, then the common or usual name must be specific to each individual hydrolyzed protein (e.g., “hydrolyzed corn protein” and “hydrolyzed soy protein”), and the ingredients must be declared in their order of predominance. In addition, any other ingredients that are blended with the hydrolyzed protein products must also be declared by their common or usual names in the ingredient statement in order of predominance. *21 CFR 101.22(h)(7)*



## Colors

### C1. What ingredient listing is used for vegetable powder?

*Answer:* Vegetable powders must be declared by common or usual name, such as “celery powder.” 21 CFR 101.22(h)(3)

### C2. What listing is used for a spice that is also a coloring?

*Answer:* Spices, such as paprika, turmeric, saffron and others that are also colorings must be declared either by the term “spice and coloring” or by the actual (common or usual) names, such as “paprika.” 21 CFR 101.22(a)(2)

### C3. What ingredient listing is used for artificial colors?

*Answer:* It depends on whether the artificial color is a certified color:

*Certified colors:* List by specific or abbreviated name such as “FD&C Red No. 40” or “Red 40.”

*Non-certified colors:* List as “artificial color,” “artificial coloring,” or by their specific common or usual names such as “caramel coloring” and “colored with beet juice.”

21 CFR 101.22(k)(1) and (2), 21 CFR 74

### C4. Do certified color additive lakes have to be declared separately from the certified color in the ingredient statement?

*Answer:* Yes. Certified color additives and their lakes are separate ingredients and, thus, must be declared separately in the ingredient statement. 21 CFR 101.22 (k)(1)

## Food Allergen Labeling

### General Information

### F1. What is the Food Allergen Labeling and Consumer Protection Act of 2004?

*Answer:* The Food Allergen Labeling and Consumer Protection Act of 2004 (FALCPA) (or Title II of Public Law 108-282) is a law that was enacted in August 2004. Among other issues, FALCPA addresses the labeling of all packaged foods regulated by the FDA. We recommend that producers of meat products, poultry products, and egg products, which are regulated by the U.S. Department of Agriculture (USDA), contact appropriate USDA agency staff regarding the labeling of such products. Also see Information about Food Allergens for more information about the agency's food allergen activities and related guidance documents that address additional FALCPA questions and answers.

<http://www.fda.gov/Food/LabelingNutrition/FoodAllergensLabeling/default.htm>

### F2. What is a “major food allergen?”

*Answer:* Under FALCPA, a “major food allergen” is an ingredient that is one of the following eight foods or food groups or an ingredient that contains protein derived from one of them:

- a. milk
- b. egg
- c. fish
- d. Crustacean shellfish



- e. tree nuts
- f. wheat
- g. peanuts
- h. soybeans

Although more than 160 foods have been identified to cause food allergies in sensitive individuals, the “major food allergens” account for 90 percent of all food allergies. Allergens other than the major food allergens are not subject to FALCPA labeling requirements.

**F3. When did the labeling requirements of the FALCPA become effective for packaged foods sold in the United States?**

*Answer:* All packaged foods regulated by FDA under the FD&C Act that are labeled on or after January 1, 2006, must comply with FALCPA's food allergen labeling requirements.

**F4. Are flavors, colors, and incidental additives subject to FALCPA labeling requirements?**

*Answer:* Yes. FALCPA labeling requirements apply to foods that are made with any ingredient, including flavorings, colorings, or incidental additives (e.g., processing aids), that is or contains a major food allergen.

**F5. Do retail and foodservice establishments have to comply with FALCPA's labeling requirements?**

*Answer:* FALCPA's labeling requirements extend to foods packaged by a retail or foodservice establishment that are offered for human consumption. However, FALCPA's labeling requirements do not apply to foods provided by a retail food establishment that are placed in a wrapper or container in response to a consumer's order - such as the paper or box used to convey a sandwich that has been prepared in response to a consumer's order.

## **Foods Not Subject To FALCPA**

**F6. Are there any foods exempt from FALCPA labeling requirements?**

*Answer:* Yes. Under FALCPA, raw agricultural commodities (generally fresh fruits and vegetables) are exempt as are highly refined oils derived from one of the eight major food allergens and any ingredient derived from such highly refined oil. In addition, FALCPA provides mechanisms by which a manufacturer may request that a food ingredient may be exempt from FALCPA's labeling requirements. See FALCPA Section 203 for details on how to request allergen labeling exemptions.

<http://www.fda.gov/Food/LabelingNutrition/FoodAllergensLabeling/GuidanceComplianceRegulatoryInformation/ucm106187.htm>

**F7. Are molluscan shellfish considered a major food allergen under FALCPA?**

*Answer:* No. Under FALCPA, molluscan shellfish (e.g., such as oysters, clams, mussels, or scallops) are not major food allergens. However, Crustacean shellfish (e.g., crab, lobster, or shrimp), and ingredients that contain protein derived from Crustacean shellfish, are major food allergens.

## Major Food Allergens (food source names and examples)

**F8. Does FALCPA provide any specific direction for declaring the presence of ingredients from the three food groups that are designated as “major food allergens (i.e., tree nuts, fish, and Crustacean shellfish)”?**

*Answer:* Yes. FALCPA requires that in the case of tree nuts, the specific type of nut must be declared (e.g., almonds, pecans, or walnuts). The species must be declared for fish (e.g., bass, flounder, or cod) and Crustacean shellfish (crab, lobster, or shrimp).

**F9. Under section 403(w)(1) of the FD&C Act, a major food allergen must be declared using the name of the food source from which the major food allergen is derived. Section 403(w)(2) of the FD&C Act provides that, in the case of fish or Crustacean shellfish, the term “name of the food source from which the major food allergen is derived” means the “species” of fish or Crustacean shellfish. What is the “species” of fish or Crustacean shellfish for purposes of section 403(w)(2)?**

*Answer:* A declaration of the “species” of fish or Crustacean shellfish for purposes of complying with Section 403(w)(2) should be made using the acceptable market name provided in FDA’s The Seafood List. The Seafood List is a compilation of existing acceptable market names for imported and domestically available seafood. We note, however, that if a “Contains” statement is used to declare the source of the fish or Crustacean shellfish, we would not object to just the type of fish or Crustacean shellfish being used, e.g., “Contains salmon” or “Contains trout.”

**F10. Section 201(qq) of the FD&C Act defines the term “major food allergen” to include “tree nuts.” In addition to the three examples provided in section 201(qq) (almonds, pecans, and walnuts), what nuts are considered “tree nuts?”**

*Answer:* The following are considered “tree nuts” for purposes of section 201(qq). The name listed as “common or usual name” should be used to declare the specific type of nut as required by section 403(w)(2).

<i>Common or usual name</i>	<i>Scientific name</i>
Almond	<i>Prunus dulcis</i> (Rosaceae)
Beech nut	<i>Fagus</i> spp. (Fagaceae)
Brazil nut	<i>Bertholletia excelsa</i> (Lecythidaceae)
Butternut	<i>Juglans cinerea</i> (Juglandaceae)
Cashew	<i>Anacardium occidentale</i> (Anacardiaceae)
Chestnut (Chinese, American, European, Seguin)	<i>Castanea</i> spp. (Fagaceae)
Chinquapin	<i>Castanea pumila</i> (Fagaceae)
Coconut	<i>Cocos nucifera</i> L. (Arecaceae (alt. Palmae))
Filbert/hazelnut	<i>Corylus</i> spp. (Betulaceae)
Ginko nut	<i>Ginkgo biloba</i> L. (Ginkgoaceae)
Hickory nut	<i>Carya</i> spp. (Juglandaceae)
Lichee nut	<i>Litchi chinensis</i> Sonn. (Sapindaceae)
Macadamia nut/Bush nut	<i>Macadamia</i> spp. (Proteaceae)
Pecan	<i>Carya illinoensis</i> (Juglandaceae)

Pine nut/Pinon nut	Pinus spp. (Pineaceae)
Pistachio	Pistacia vera L. (Anacardiaceae)
Sheanut	Vitellaria paradoxa C.F. Gaertn. (Sapotaceae)
Walnut (English, Persian, Black, Japanese, California), Heartnut	Juglans spp. (Juglandaceae)

The foregoing list reflects FDA's current best judgment as to those nuts that are "tree nuts" within the meaning of Section 201(qq). In order to be comprehensive, this list employs broad scientific categories that may include a species that currently has no food use. The fact that a species falls within a scientific category on this list does not mean that the species is appropriate for food use. FDA further advises that, as with any guidance, the list may be revised consistent with the process for revising guidance documents in our regulation on good guidance practices in 21 CFR 10.115.

**F11. Section 201(qq) of the FD&C Act includes "wheat" in the definition of major food allergen. What is considered "wheat" for purposes of Section 201(qq)?**

**Answer:** The term "wheat" in Section 201(qq) means any species in the genus Triticum. Thus, for the purposes of Section 201(qq), wheat would include grains such as common wheat (*Triticum aestivum* L.), durum wheat (*Triticum durum* Desf.), club wheat (*Triticum compactum* Host.), spelt (*Triticum spelta* L.), semolina (*Triticum durum* Desf.), Einkorn (*Triticum monococcum* L. subsp. *Monococcum*), emmer (*Triticum turgidum* L. subsp. *dicocon* (Schrank) Thell.), kamut (*Triticum polonicum* L.), and triticale (x *Triticosecale* spp. Wittm.).

**F12. May singular terms be substituted for the plural terms "peanuts," "soybeans" and the different types of "tree nuts" (e.g., almonds, pecans, or walnuts), and may synonyms for the term "soybean" be used to satisfy the labeling requirements of FALCPA?**

**Answer:** Yes. FDA believes that the singular terms "peanut," and "soybean," as well as the singular terms (e.g., almond, pecan, or walnut) for the different types of tree nuts are acceptable substitutes for the plural terms for these major food allergens for the purpose of satisfying the FALCPA labeling requirements. Also, the terms "soybean," "soy," and "soya" are reasonable synonyms for the common or usual name "soybeans," and any one of these terms may be used to identify the food source of the major food allergen "soybeans." However, packaged foods that are made using "soybeans" as an ingredient or as a component of a multi-component ingredient (e.g., soy sauce or tofu) should continue to use the word "soybeans" as the appropriate common or usual name for this ingredient to identify properly the ingredient (e.g., "soy sauce (water, wheat, soybeans, salt)").

**FALCPA Labeling (provisions and examples)**

**F13. How must major food allergens be declared on food labels to comply with FALCPA?**

**Answer:** FALCPA requires food manufacturers to label food products that are made with an ingredient that is a major food allergen in one of the ways shown at right.

## Nutrition Facts

**Ingredients:** Enriched flour (wheat flour, malted barley, niacin, reduced iron, thiamin mononitrate, riboflavin, folic acid), sugar, partially hydrogenated cottonseed oil, high fructose corn syrup, whey (milk), eggs, vanilla, natural and artificial flavoring, salt, leavening (sodium acid pyrophosphate, monocalcium phosphate), lecithin (soy), mono- and diglycerides.

Any Cookie Company  
College Park, MD 20740

1. Include the name of the food source in parenthesis following the common or usual name of the major food allergen in the list of ingredients in instances when the name of the food source of the major food allergen does not appear elsewhere in the ingredient statement for another allergenic ingredient.

**OR**

2. Place the word "Contains," followed by the name of the food source from which the major food allergen is derived, immediately after or adjacent to the list of ingredients, in a type size that is no smaller than that used for the ingredient list.

## Nutrition Facts

**Ingredients:** Enriched flour (wheat flour, malted barley, niacin, reduced iron, thiamin mononitrate, riboflavin, folic acid), sugar, partially hydrogenated cottonseed oil, high fructose corn syrup, whey, eggs, vanilla, natural and artificial flavoring, salt, leavening (sodium acid pyrophosphate, monocalcium phosphate), lecithin, mono- and diglycerides.

**Contains:** Wheat, Milk, Egg and Soy.

Any Cookie Company  
College Park, MD 20740

**F14. Are single ingredient foods that are major food allergens required to comply with FALCPA?**

*Answer:* Yes. Single ingredient foods must comply with the allergen declaration requirements in Section 403(w)(1). A single ingredient food that is, or contains protein derived from milk, egg, fish, Crustacean shellfish, tree nuts, wheat, peanuts, or soybeans, may identify the food source in the name of the food (e.g., “all-purpose wheat flour”) or use the “Contains” statement format. FDA recommends that if a “Contains” statement format is used, the statement be placed immediately above the manufacturer, packer, or distributor statement. For single ingredient foods intended for further manufacturing where the “Contains” statement format is used, the statement should be placed on the PDP of the food.

**F15. May a “Contains” statement on a food label provided in accordance with FALCPA list only the names of the food sources of the major food allergens that are not already identified in the ingredient list for a packaged food?**

*Answer:* No. If a “Contains” statement is used on a food label, the statement must include the names of the food sources of all major food allergens used as ingredients in the packaged food. For example, if “sodium caseinate,” “whey,” “egg yolks,” and “natural peanut flavor” are declared in a product’s ingredients list, any “Contains” statement appearing on the label immediately after or adjacent to that statement is required to identify all three sources of the major food allergens present (e.g., “Contains milk, egg, peanuts”) in the same type (i.e., print or font) size as that used for the ingredient list.

**F16. Is there more than one way to word a “Contains” statement used to declare the major food allergens in a packaged food?**

*Answer:* Yes. The wording for a “Contains” statement may be limited to just stating the word “Contains” followed by the names of the food sources of all major food allergens that either are or are contained in ingredients used to make the packaged product. Alternatively, additional wording may be used for a “Contains” statement to more accurately describe the presence of any major food allergens, provided that the following three conditions are met:

- The word “Contains” with a capital “C” must be the first word used to begin a “Contains” statement. (The use of bolded text and punctuation within a “Contains” statement is optional.)
- The names of the food sources of the major food allergens declared on the food label must be the same as those specified in the FALCPA, except that the names of food sources may be expressed using singular terms versus plural terms (e.g., walnut versus walnuts) and the synonyms “soy” and “soya” may be substituted for the food source name “soybeans.”
- If included on a food label, the “Contains” statement must identify the names of the food sources for all major food allergens that either are in the food or are contained in ingredients of the food.

## 7. NUTRITION LABELING

### General

#### G1. Where should the Nutrition Facts label be placed on food packages?

**Answer:** The Nutrition Facts label may be placed together with the ingredient list and the name and address (name and address of the manufacturer, packer, or distributor) on the PDP. These three label statements also may be placed on the information panel (the label panel adjacent and to the right of the PDP, or, if there is insufficient space on the adjacent panel, on the next adjacent panel to the right). On packages with insufficient area on the PDP and information panel, the Nutrition Facts label may be placed on any alternate panel that can be seen by the consumer. *21 CFR 101.2(b) & (e) & 101.9(i)*

#### G2. Is it necessary to use a nutrition display with a box shape on a round package?

**Answer:** Yes. Even when using the tabular display, the nutrition information must be set off in a box. *21 CFR 101.9(d)(1)(i)*

#### G3. Can the product name be placed within the Nutrition Facts label?

**Answer:** No. The name may be placed above the box that encloses the nutrition information. *21 CFR 101.9(c) & (d)*

#### G4. Can the Nutrition Facts label be oriented perpendicularly as opposed to parallel, to the base of the package?

**Answer:** Yes. There is no requirement that any information, other than the net quantity of contents and statement of identity, be printed parallel to the base of the package. However, FDA urges manufacturers to strive for consistency of presentation of nutrition information in the market and to place the Nutrition Facts label so that it is readily observable and legible to the consumer at the point of purchase.

#### G5. Is a break in the vertical alignment allowed with the standard format?

**Answer:** Yes. The vertical format may be broken in either of the following ways: (1) placement of the footnote to the right of the panel as shown in the example in *21 CFR 101.9(d)(11)* or (2) all vitamins and minerals that are listed voluntarily (i.e., after iron) may be moved to the top right of the panel along with the footnote. *21 CFR 101.9(d)(11)*

### Nutrient Declaration

#### N1. Are Nutrition Facts labels required on all foods?

**Answer:** The Nutrition Facts label (an example is illustrated in section 7 L2) is required on most food packages labeled. The illustration indicates FDA's typeface and style to help assure readability and conspicuousness. Not all of these type specifications are required. The mandatory type specifications are listed in *21 CFR 101.9(d)*. Unlike the illustrative examples in this guidance, (1) Any legible type style may be used, not just Helvetica, (2) The heading Nutrition Facts must be the largest type size in the nutrition label (i.e., it must be larger than 8-point, but does not need to be 13-point) and should extend the width of the Nutrition Facts box, and (3) There is no specific thickness

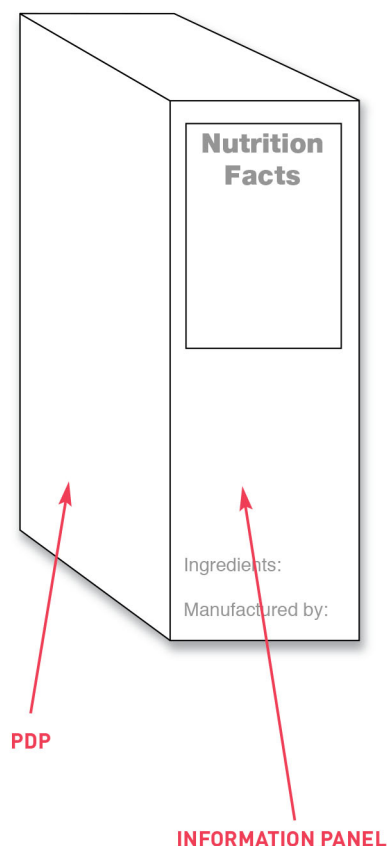

required for the three bars that separate the central sections of the nutrition label. 21 CFR 101.9(a) and 21 CFR 101.9(a)(1)

Below are listed categories providing exemptions or special provisions for nutrition labeling. Generally, a food package loses those exemptions, if a nutrition claim is made or nutrition information is provided: -

<b>Summary of Exemption</b>	<b>Regulation #</b>
Manufactured by small businesses	21 CFR 101.9(j)(1) and 101.9(j)(18)
Food served in restaurants, etc. or delivered to homes ready for immediate consumption	21 CFR 101.9(j)(2)
Delicatessen-type food, bakery products and confections that are sold directly to consumers from the location where prepared	21 CFR 101.9(j)(3)
Foods that provide no significant nutrition such as instant coffee (plain, unsweetened) and most spices	21 CFR 101.9(j)(4)
Infant formula, and infant and junior foods for children up to 4 years of age (modified label provisions for these categories)	21 CFR 101.9(j)(5) and 101.9(j)(7)
Dietary supplements (must comply with 21 CFR 101.36)	21 CFR 101.9(j)(6)
Medical foods	21 CFR 101.9(j)(8)
Bulk foods shipped for further processing or packaging before retail sale	21 CFR 101.9(j)(9)
Fresh produce and seafood (a voluntary nutrition labeling program covers these foods through the use of the appropriate means such as shelf labels, signs, and posters)	21 CFR 101.9(j)(10) and 101.45
Packaged single-ingredient fish or game meat may be labeled on basis of 3-ounce cooked portion (as prepared). Custom-processed fish and game are exempt from nutrition labeling.	21 CFR 101.9(j)(11)
Certain egg cartons (nutrition information inside lid or on insert in carton)	21 CFR 101.9(j)(14)
Packages labeled “This unit not labeled for retail sale” within multiunit package, and outer wrapper bears all required label statements	21 CFR 101.9(j)(15)
Self-service bulk foods-nutrition labeling by placard, or on original container displayed clearly in view	21 CFR 101.9(a)(2) and 101.9(j)(16)
Donated food that is given free (not sold) to the consumer.	You are not required to put Nutrition Facts labels on donated food unless the donated food is later placed on sale (the law applies only to food that is “offered for sale”) – 21 CFR 101.9(a)
Game meats may provide required nutrition information on labeling in accordance with 21 CFR 101.9(a)(2) (eg. counter cards)	21 CFR 101.9(j)(12)



**N2. Are nutrition designations permitted on food package labels?**

*Answer:* FDA considers information that is required or permitted in the Nutrition Facts label that is on the front label or elsewhere on the package outside the Nutrition Facts label to be a Nutrient Content Claim (NCC). In such cases, the package label must comply with the regulations for nutrient content claims. See the NCC section and Appendices A and B of this document for more information. *21 CFR 101.13(c)*

**N3. What other nutrients can be declared on the Nutrition Facts label?**

*Answer:* In addition to the nutrients shown on the label in section 7 L2 manufacturers may add calories from saturated fat, polyunsaturated fat, monounsaturated fat, potassium, soluble and insoluble fiber, sugar alcohol, other carbohydrate, vitamins and minerals for which Reference Daily Intake (RDI's) have been established, or the percent of vitamin A that is present as beta-carotene. *21 CFR 101.9(c)*

**N4. Is there a restriction against certain nutrients in the Nutrition Facts label?**

*Answer:* Only those nutrients listed in FDA's nutrition regulations, as mandatory or voluntary components of the nutrition label, may be included in the Nutrition Facts label. *21 CFR 101.9(c)*

**N5. When must voluntary nutrients be listed?**

*Answer:* In addition to the nutrients shown on the sample labels in this guidance, other nutrients (listed in FDA's regulations, e.g., thiamin) must be included in a food's Nutrition Facts label if the nutrients are added as a nutrient supplement to the food, if the label makes a nutrition claim (such as a NCC) about them, or if advertising or product literature provides information connecting the nutrients to the food. *21 CFR 101.9(a)*, *21 CFR 101.9(c)*, *21 CFR 101.9(c)(8)(ii)*

**N6. When should the vitamins and minerals in flour be listed on the Nutrition Facts label?**

*Answer:* Generally, FDA only requires that the label declare the vitamins A and C, and the minerals calcium and iron. The other enrichment vitamins and minerals must be declared when they are added directly to the packaged food (e.g., enriched bread), but not when the enriched product is added as an ingredient to another food. NOTE: It is necessary to declare the other vitamins and minerals in the ingredient list. However, if unenriched flour is used, and the enrichment nutrients are added separately, those nutrients (i.e., thiamin, riboflavin, niacin, and folic acid) would have to be declared on the Nutrition Facts label. *21 CFR 101.9(c)(8)(ii)(A)-(B)* and *21 CFR 101.9(c)(8)(iv)*

**N7. When the caloric value for a serving of a food is less than 5 calories, can the actual caloric value be declared?**

*Answer:* The caloric value of a product containing less than 5 calories may be expressed as zero or to the nearest 5 calorie increment (i.e., zero or 5 depending on the level). Foods with less than 5 calories meet the definition of "calorie free" and any differences are dietarily insignificant. *21 CFR 101.9(c)(1)*

**N8. Should a value of 47 calories be rounded up to 50 calories or rounded down to 45 calories?**

*Answer:* Calories must be shown as follows:

50 calories or less—Round to nearest 5-calorie increment:

**Example: Round 47 calories to “45 calories”**

Above 50 calories—Round to nearest 10-calorie increment:

**Example: Round 96 calories to “100 calories”**

21 CFR 101.9(c)(1) Also see Appendix H for rounding guidelines.

**N9. How are calories from alcohol to be calculated?**

*Answer:* Calories from alcohol may be calculated using specific Atwater factors as provided for in 21 CFR 101.9(c)(1)(i)(A). USDA Handbook No. 74 provides a specific food factor of 7.07 calories per gram of alcohol.

**N10. What is total fat?**

*Answer:* To determine the total fat content of a food, add the weight in grams of all lipid fatty acids in the food (e.g., lauric, palmitic, stearic fatty acids) and express as triglycerides. Total fat = Weight of all individual fatty acids + weight of one unit of glycerol for each three fatty acids. 21 CFR 101.9(c)(2)

**N11. Does total fat, which is defined as total lipid fatty acid expressed as triglycerides, include cholesterol?**

*Answer:* No.

**N12. The total fat content for a serving of my product is 0.1 g. How should I declare fat and calories from fat?**

*Answer:* Because it is present at a level below 0.5 g, the level of fat is expressed as 0 g. Calories from fat would also be expressed as zero.

21 CFR 101.9(c)(1)(i), 21 CFR 101.9(c)(2)

**N13. What fractions are used for total fat on the Nutrition Facts label?**

*Answer:* Below 0.5 grams total fat per serving: Use the declaration 0 grams for total fat. 0.5 grams to 5 grams total fat: Use 0.5 gram increments rounded to the nearest 1/2 gram.

**Examples:** 0.5 g, 1 g, 1.5 g, 2 g, 2.5 g, 3 g, 3.5 g, 4 g, 4.5 g, 5 g -

Above 5 grams: Use 1 gram increments rounded to the nearest 1 gram (do not use fractions above 5 grams). -

**Examples:** 5 g, 6 g, 7 g, etc. -

21 CFR 101.9(c)(2) Also see Appendix H for rounding guidelines.

**N14. What values are used for calculating Daily Values for the nutrition label?**

*Answer:* See Appendix F: Calculate the percent daily value (DV) for the appropriate nutrients and Appendix G: Daily Values for Infants, Children Less Than 4 Years of Age, and Pregnant and Lactating Women.

21 CFR 101.9(c)(8)(iv) & (c)(9)



**N15. When less than 0.5 grams of dietary fiber or saturated fat is present in a serving of a product, the amounts would be shown as zero on the label. However, when the % DV is calculated based on an actual unrounded fiber or saturated fat content of 0.2 grams per serving, the calculation yields 1 percent. To avoid consumer confusion can the % DV be expressed as zero in these cases?**

*Answer:* Yes. Section 101.9(d)(7)(ii) permits the percent Daily Value to be calculated by dividing either the amount declared on the label for each nutrient or the actual amount of each nutrient (i.e., before rounding) by the Daily Reference Value (DRV) for that nutrient except that the percent for protein must be calculated as specified in 21 CFR 101.9(c)(7)(ii). As a result of this change, whenever a declared quantitative amount is zero, the declared percent Daily Value will also be zero.

**N16. How is total carbohydrate calculated?**

*Answer:* Total carbohydrate is calculated by subtracting the weight of crude protein, total fat, moisture, and ash from the total weight of the sample of food. 21 CFR 101.9(c)(6)

**N17. Does total carbohydrate include dietary fiber?**

*Answer:* Yes. Dietary fiber must be listed as a subcomponent under total carbohydrate. 21 CFR 101.9(c)(6)

**N18. What is meant by sugars on the Nutrition Facts label?**

*Answer:* To calculate sugars for the Nutrition Facts label, determine the weight in grams of all free monosaccharides and disaccharides in the sample of food. 21 CFR 101.9(c)(6)(ii)

**N19. I have 0.8 grams of fiber in a serving of food. Can I round this up to 1 g, or must I use the statement “less than 1 g?” Can I do the same thing for protein?**

*Answer:* Since this serving contains less than 1 gram of dietary fiber per serving, fiber is to be expressed as “Less than 1 gram” or “Contains less than 1 gram,” or the manufacturer has the option to not list dietary fiber and include the following statement at the bottom of the table of nutrients: “Not a significant source of dietary fiber.” Protein can be expressed to the nearest whole gram (i.e., 1 g); or the label can state “less than 1 gram” or “Contains less than 1 gram.” The “<” symbol may be used in place of the words “less than” (21 CFR 101.9(d)(7)(i)). 21 CFR 101.9(c)(6)(i), 21 CFR 101.9(c)(7)

**N20. Under what circumstances is the listing of sugar alcohol required?**

*Answer:* When a claim is made on the label or in labeling about sugar alcohol or sugars when sugar alcohols are present in the food. 21 CFR 101.9(c)(6)(iii)

**N21. What DRV's and RDI's are established for protein for the purpose of listing protein as a percent of Daily Value (% DV)?**

*Answer:* The DRV for protein for adults and children 4 or more years of age is 50 grams. The RDIs for protein for children less than 4 years of age, infants, pregnant women, and lactating women are established at 16 grams, 14 grams, 60 grams, and 65 grams respectively. 21 CFR 101.9(c)(7)(iii)

**N22. Why is the declaration of the DRV for protein not mandatory?**

*Answer:* The percent of the DRV is required if a protein claim is made for the product or if the product is represented or purported to be for use by infants or children under 4 years of age. Based on current scientific evidence that protein intake is not a public health concern for adults and children over 4 years of age, and because of the costs associated with a determination of the Protein Digestibility Corrected Amino Acid Score (PDCAAS), FDA has determined that declaration of the percent of the DRV for protein need not be provided when a claim is not made.

**N23. How should the % DV for protein be expressed when it is provided on labeling of foods for adults and children over four?**

*Answer:* When protein is listed as a percent of the 50 gram DRV and expressed as % DV, the % DV is calculated by correcting the actual amount of protein in grams per serving by multiplying the amount by its amino acid score corrected for protein digestibility, dividing by 50 grams, and converting to percent. *21 CFR 101.9(c)(7)(ii)*

**N24. When % DV's for protein and potassium are included on the Nutrition Facts label on foods for adults and children over 4 years, where in the footnote is the DRV information to be placed?**

*Answer:* Protein should be listed in the footnote under dietary fiber with the DRV inserted on the same line in the numeric columns. The DRV for protein is based on 10 percent of calories as protein, which equates to 50 grams for a 2,000 calorie diet and 65 grams (62.5 rounded up to 65) for a 2,500 calorie diet. Similarly, potassium would be listed in the footnote under sodium. The DRV for potassium is 3,500 milligrams for both the 2,000 and 2,500 calorie diets. *21 CFR 101.9(d)(9)*

**N25. How do I determine what values to declare on the Nutrition Facts label?**

*Answer:* The nutrient values declared on the Nutrition Facts label are based on the nutrient profile of the product, as packaged, rounded as required by regulation. Rounding rules are provided in *21 CFR 101.9(c)* and summarized in Appendix H.

**N26. How should vitamins and minerals that are permitted to be listed voluntarily be listed?**

*Answer:* If potassium is listed, it should be listed in bold type directly under sodium. Voluntary vitamins and minerals (i.e., those other than vitamin A, vitamin C, calcium, and iron), should be declared horizontally or vertically following the required vitamins and minerals in the order listed in *21 CFR 101.9(c)(8)(iv)*, *21 CFR 101.9(c)(5)* and *21 CFR 101.9(d)(8)*

**N27. Is it legal to declare 400% of the Daily Value for a vitamin?**

*Answer:* Yes. The percent Daily Value is based on the amount of the nutrient present in the product.

**N28. Can information about nutrients that do not have an RDI/DRV such as boron and omega-3 fatty acids be provided on the food label?**

*Answer:* Yes, provided that the information is truthful and not misleading and is provided outside the Nutrition Facts label. Such information is limited to statements of amount or percent of a nutrient (eg. 300 mg omega 3) and may not characterize the level of the nutrient (you may not state "High in Omega-3"). *21 CFR 101.13(i)(3)*

**N29. Would a dry mix product such as flavored rice be required to provide nutrition information for both the product as packaged and as prepared?**

*Answer:* Only the nutritional properties of the product as packaged is required. However, nutritional information may be voluntarily presented “as prepared” as provided for in *21 CFR 101.9(h)(4)*. *21 CFR 101.9(e)*

**N30. Can I use “average” values derived from data bases to determine the nutrient content of my product?**

*Answer:* FDA has not stated how a company should determine the nutrient content of their product for labeling purposes. Therefore, there is no prohibition from using “average” values for its product derived from data bases if a manufacturer is confident that the values obtained meet FDA's compliance criteria. Regardless of its source, a company is responsible for the accuracy and the compliance of the information presented on the label. Use of a data base that has been accepted by FDA affords a firm some measure of security in that the agency has stated that it will work with industry to resolve any compliance problems that might arise for food labeled on the basis of a data base that the agency has accepted. A manual entitled *FDA Nutrition Labeling Manual: A Guide for Developing and Using Databases* is available online.

**N31. How many samples of each product should we analyze for nutrition labeling?**

*Answer:* FDA has not defined the number of samples that must be analyzed. It is the responsibility of the manufacturer/packer/distributor to determine the variability of their product(s) and the number of samples needed to provide accurate nutrient data. The *FDA Nutrition Labeling Manual: A Guide for Developing and Using Databases*, available from FDA, may be of assistance in this area. FDA will use a composite of 12 units when performing enforcement analyses. *21 CFR 101.9(g)*

**N32. May I copy my competitor's label?**

*Answer:* Firms are responsible for the accuracy of the Nutrition Facts label and there is no assurance that the data from a competitor's product is valid for another product. Products of a similar nature are not necessarily equivalent in ingredients and nutrient value. If FDA found a product to be out of compliance because a firm merely copied its competitor's label, the firm would be hard pressed to prove that they labeled the product “in good faith.”

**N33. Will FDA analyze my products and send me a report to use for my nutrition label?**

*Answer:* No. FDA does not have the resources to analyze products upon request. However, FDA will collect surveillance samples to monitor the accuracy of nutrition information. The manufacturer, packer or distributor would be advised of any analytical results that are not in compliance. Additionally, depending on circumstances, FDA may initiate regulatory action.

**N34. Does FDA provide data base information to industry?**

*Answer:* No. FDA will review and accept industry data bases which remain the property of the organization that developed and submitted the data.

**N35. Can FDA recommend an analytical laboratory and must a laboratory be approved to perform nutrient analysis?**

*Answer:* FDA does not approve, and is not in a position to endorse or recommend, specific laboratories. Assistance may be available through the following sources: trade and professional associations, trade publications, colleges and universities, and by looking in local phone books under testing or analytical laboratories. For compliance purposes for nutrient analysis, FDA uses appropriate methods published by the Association of Analytical Chemists (AOAC) in *Official Methods of Analysis of the AOAC International* (the most current edition unless otherwise stated in the CFR) or other methods as needed. You may wish to ascertain if the laboratory is familiar with these methodologies when selecting a laboratory.

**N36. How many samples must be analyzed to determine the nutrient levels for a product?**

*Answer:* The number of samples to analyze for each nutrient is determined by the variability of each nutrient in a food. Fewer analytical samples are generally required for nutrients that are less variable. The variables that affect nutrient levels should be determined, and a sampling plan should be developed to encompass these variables.

**N37. Is there a problem with using ingredient composition data bases to calculate the values for nutrition labeling?**

*Answer:* If manufacturers choose to use ingredient data bases, they should be assured of the accuracy of the databases and validate the resulting calculations by comparing them with values for the same foods obtained from laboratory analyses. Manufacturers are responsible for the accuracy of the nutrition labeling values on their products. Although FDA specifies the laboratory methods that will be used to evaluate the accuracy of the labeled products, FDA does not specify acceptable sources for the labeled values.

## **Products with Separately Packaged Ingredients/Assortments of Foods/Gift Packages**

**P1. Can the Nutrition Facts label on a box containing dry noodles and a seasoning packet list the nutrients in the noodles separately from the seasoning packet? If so, must a column be included that gives the total nutrients for the noodles and the seasoning packet?**

*Answer:* Section 101.9(h)(1) provides the option of listing nutrition information per serving for each component or as a composite value. The decision is up to the manufacturer. A column of total values is not required.

**P2. What are the labeling options for products packed in an assortment that are intended to be eaten at the same time? Can the nutrient analysis for a product containing a mixture of nuts or different types of dried fruit be based on a composite of the mixture blended together?**

*Answer:* Section 101.9(h)(1) allows the nutrition information for assortments of the same type of food (e.g., mixed nuts or mixed fruits) that are intended to be consumed at the same time to be specified for each component or as a composite value. Therefore, if it is reasonable to assume that a consumer would eat an assortment of the nuts or fruits offered, a single composite analysis may be used to determine the nutrient composition.

**P3. What is the correct way to label a gift basket that contains a variety of foods, candies, and liquors of various sizes? Does nutrition labeling have to be provided for each individually wrapped product, and are such packages considered multi-packs?**

*Answer:* Nutrition labeling of gift food packages is addressed in 21 CFR 101.9(h)(3) which:

1. allows nutrition information to be placed on the label of the outer package or in labeling within or attached to the outer package,
2. provides for standardized serving sizes when there is no RACC appropriate for the variety of foods in the gift pack,
3. allows number of servings per container to be listed as “varied,”
4. allows nutrition information to be given as a composite for categories of foods in the gift pack that have similar dietary uses and similar nutritional characteristics (e.g., assorted chocolate candies, assorted cheeses), and
5. does not require declaration of nutrients in free promotional items or items used in small quantities to enhance the appearance of the gift package.

The required nutrition information for different foods may be put on a brochure or package insert using the aggregate display illustrated in 21 CFR 101.9(d)(13)(ii). Listing the servings per container as “varied” allows use of the same nutrition label on packages of varied sizes.

If some individually wrapped food items in the gift pack bear nutrition labeling, that information need not be repeated with the nutrition information provided for the unlabeled foods (e.g., on the outside of the gift pack or on a package insert). Further, the labeling of all malt beverages, regardless of alcohol content, and of liquors and wines containing 7 percent or more by volume of alcohol is regulated by the Alcohol and Tobacco Tax and Trade Bureau (TTB). TTB does not require that the products it regulates bear nutrition labeling.

**P4. A retailer assembles gift packages containing a mixture of prepackaged and pre-labeled foods from the following categories: (1) Food items in packages that bear Nutrition Facts in accordance with 21 CFR 101.9, (2) packages with less than 12 square inches of available label space that may be obtained. What are the nutrition labeling requirements for gift packages containing these foods?**

*Answer:* Gift packages are required to bear nutrition labeling in accordance with current labeling regulations. The following rules apply to the above categories:

1. When individual food packages within a gift package bear complete nutrition labeling, the nutrition information need not be repeated on the outer wrapper or in a package insert, even when such means are used to convey nutrition information on other products within the gift package.
2. Available label space is not an issue for most gift packages since the required information may be placed on the larger outer wrapper or in a package insert. Therefore, when packages with less than 12 square inches of available label space are added to a gift package, the nutrition information should be obtained from the manufacturer and placed on or within the gift package. Free promotional items and items used in small quantities to enhance the appearance of the gift package are excused from this requirement (21 CFR 101.9(h)(3)(v)).

3. Nutrition labeling must be placed on the outer wrapper or on a package insert for all foods in a gift package (except free promotional items and items used in small quantities to enhance the appearance of the gift package) that do not bear the required nutrition information on the package label.

**P5. Must inserts for gift packages follow the standard format? May other displays such as the tabular display be used on the insert?**

*Answer:* The full format must be used because the space available is not limited by the size of the label.

**P6. Is nutrition labeling required for fresh fruit included in a gift package?**

*Answer:* Nutrition labeling is not required when the entire package is made up of fresh fruits (which fall under the voluntary nutrition labeling program) or when the fruit is packed with other processed foods that are intended to be eaten separately. However, if the fruit is included as one part of a kit with more than one ingredient, and some of the other ingredients are not subject to the voluntary labeling exemption, nutrition labeling is required (e.g., apples and caramel sauce).

**P7. When cello pack labeling of fresh fruits or vegetables includes a claim, must nutrition information be provided on the label?**

*Answer:* Claims subject the food to nutrition labeling in accordance with 21 CFR 101.45, which means that nutrition information will have to be available at point of purchase although not necessarily on the package.

**P8. I assemble gift packs using prepackaged foods manufactured by other companies. Labeling on my part is limited to adding a “Contents List” which includes my company name and address. The gift pack is featured in the same manner in my catalogue. While some of these products have nutrition labeling, some do not because the manufacturers have a small business exemption and no claims are made. Am I responsible for providing nutrition labeling for the items that do not carry nutrition information?**

*Answer:* Nutrition labeling must be made available for all foods in a gift pack unless the individual food product qualifies for a small business exemption. Section 101.9(h)(3)(i) allows for the added nutrition information to be placed on an insert in the gift pack rather than on each package label.

## **Label Formats/Graphic Requirements**

### *General*

**L1. How large must the Nutrition Facts label be?**

*Answer:* There are no specific size requirements for the nutrition label. However, the “Nutrition Facts” heading must be in a type size larger than all other print size in the nutrition label and generally set the full width of the nutrition facts label (21 CFR 101.9(d)(2)). Minimum type sizes of 6 point and 8 point are required for the other information in the nutrition label (21 CFR 101.9(d)(1)(iii)), and there are minimum spacing requirements between lines of text (21 CFR 101.9(d)(1)(ii)(C)).



**L2. What are the minimum type sizes and other format requirements for the Nutrition Facts label?**

*Answer:* Format requirements are specified in 21 CFR 101.9(d). For example, the nutrition information must be set off in a box by use of hairlines and must be all black or one color type, printed on a white or other neutral contrasting background whenever practical. 21 CFR 101.9(d)(1)(i)

FDA urges that the nutrition information be presented using the graphic specifications set forth in appendix B to part 101 (see below).

**Example of Graphic Enhancements used by FDA**

**Nutrition Facts**

Serving Size 1 cup (228g)  
Servings Per Container 2

---

**Amount Per Serving**

**Calories** 260      **Calories from Fat** 120

---

% Daily Value\*

**Total Fat** 13g  
Saturated Fat 5g  
*Trans Fat* 2g

---

**Cholesterol** 30mg

---

**Sodium** 660mg

---

**Total Carbohydrate** 31mg  
Dietary Fiber 0g  
Sugars 5g

---

**Protein** 5g

---

Vitamin A 4%      •      Vitamin C 2%  
Calcium 15%      •      Iron 4%

\* Percent Daily Values are based on a 2,000 calorie diet. Your Daily Values may be higher or lower depending on your calorie needs:

	Calories:	2,000	2,500
Total Fat	Less than	65g	80g
Sat Fat	Less than	20g	25g
Cholesterol	Less than	300mg	300mg
Sodium	Less than	2,400mg	2,400mg
Total Carbohydrate		300g	375g
Dietary Fiber		25g	30g

**Annotations:**

- Helvetica Regular 8 point with 1 point of leading
- Franklin Gothic Heavy or Helvetica Black, flush left & flush right, no smaller than 13 point
- 3 point rule
- 7 point rule
- 1/4 point rule centered between nutrients (2 points leading above and 2 points below)
- 6 point Helvetica Black
- 8 point Helvetica Regular with 4 points of leading
- All labels enclosed by 1/2 point box rule within 3 points of text measure
- 1/4 point rule
- 8 point Helvetica Regular, 4 points of leading with 10 point bullets
- Type below vitamins and minerals (footnotes) is 6 point with 1 point of leading

## Typeface and Size

1. The Nutrition Facts label uses 6 point or larger Helvetica Black and/or Helvetica Regular type. In order to fit some formats the typography may be kerned as much as -4 (tighter kerning reduces legibility).
2. Key nutrients & their % Daily Value are set in 8 point Helvetica Black (but “%” is set in Helvetica Regular).
3. Nutrition Facts is set in either Franklin Gothic Heavy or Helvetica Black to fit the width of the label flush left and flush right.
4. Serving Size and Servings per container are set in 8 point Helvetica Regular with 1 point of leading.
5. The table labels (for example, “Amount per Serving”) are set in 6 point Helvetica Black.
6. Absolute measures of nutrient content (for example, “1g”) and nutrient subgroups are set in 8 point Helvetica Regular with 4 points of leading.
7. Vitamins and minerals are set in 8 point Helvetica Regular, with 4 points of leading, separated by 10 point bullets.
8. All type that appears under vitamins and minerals is set in 6 point Helvetica Regular with 1 point of leading.

## Rules

1. A 7 point rule separates large groupings as shown in the example. A 3 point rule separates calorie information from the nutrient information.
2. A hairline rule or 1/4 point rule separates individual nutrients, as shown in the example. The top half of the label (nutrient information) has 2 points of leading between the type and the rules, the bottom half of the label (footnotes) has 1 point of leading between the type and the rules.

## Box

All labels are enclosed by ½ point box rule within 3 points of text measure.

### **L3. Must all of the type specifications shown with the nutrition format example of section 7 L2 (above) be followed?**

*Answer:* No. The mandatory type specifications are listed in *21 CFR 101.9(d)*. Unlike the illustrative example of section 7 L2 (above):

1. Any legible type style may be used, not just Helvetica.
2. The heading Nutrition Facts must be the largest type size in the nutrition label (i.e., it must be larger than 8-point, but does not need to be 13-point).
3. There is no specific thickness required for the three bars that separate the central sections of the nutrition label.

### **L4. Can I use type sizes larger than 8 point and 6 point?**

*Answer:* The requirement for 6 and 8 point type sizes are minimum requirements. Larger type sizes may be used.

### **L5. Where should the Nutrition Facts appear on the food label?**

*Answer:* Under *21 CFR 101.9(j)(13)(ii)(D)* the Nutrition Facts may be presented on any label panel when the total surface available for labeling is 40 or less square inches. Packages with more than 40 square inches of available space must place the nutrition information on either the PDP or information panel as defined in *21 CFR 101.2* unless there is insufficient space (excluding vignettes, etc.), in which case the Nutrition Facts may be placed on any panel that may be seen readily by consumers. *21 CFR 101.9(j)(17)*



**L6. Can print be condensed?**

*Answer:* Yes, however, if condensing results in a label that does not meet minimum type size requirements, FDA would consider the label misleading. 21 CFR 101.9(d)(1)(iii)

**L7. What can be done if the regular Nutrition Facts label (i.e., the vertical format) does not fit the package?**

*Answer:* On packages with more than 40 square inches available to bear labeling, the “side-by-side” format may be used if the regular Nutrition Facts label does not fit. In this format, the bottom part of the Nutrition Facts label (following the vitamin and mineral information) is placed immediately to the right and separated with a line. If additional vitamins and minerals are listed after iron and the space under iron is inadequate, they may also be listed to the right with a line that sets them apart from the footnotes.

<b>Nutrition Facts</b>		*Percent Daily Values are based on a 2,000 calorie diet. Your Daily Values may be higher or lower depending on your calorie needs:	
Serving Size 1 Cup (228g) Servings Per Container 2		Calories: 2,000 2,500	
<b>Amount Per Serving</b>		Total Fat	Less than 65g 80g
<b>Calories</b> 260	Calories from Fat 120	Sat Fat	Less than 20g 25g
<b>% Daily Value*</b>		Cholesterol	Less than 300mg 300mg
<b>Total Fat</b> 13g	<b>20%</b>	Sodium	Less than 2,400mg 2,400mg
Saturated Fat 5g	<b>25%</b>	Total Carbohydrate	300g 375g
Trans Fat 2g		Dietary Fiber	25g 30g
<b>Cholesterol</b> 30mg	<b>10%</b>	Calories per gram: Fat 9 • Carbohydrate 4 • Protein 4	
<b>Sodium</b> 660mg	<b>28%</b>		
<b>Total Carbohydrate</b> 31g	<b>10%</b>		
Dietary Fiber 0g	<b>0%</b>		
Sugars 5g			
<b>Protein</b> 5g			
Vitamin A 4%	•	Vitamin C 2%	
Calcium 15%	•	Iron 4%	

Also, if the package has insufficient continuous vertical space (i.e., about 3 inches) to accommodate the above format, the nutrition label may be presented in a tabular (i.e., horizontal) display. 21 CFR 101.9(d)(11)

<b>Nutrition Facts</b>	<b>Amount Per Serving</b>	<b>% Daily Value*</b>	<b>Amount Per Serving</b>	<b>% Daily Value*</b>	*Percent Daily Values are based on a 2,000 calorie diet. Your Daily Values may be higher or lower depending on your calorie needs:	
	<b>Total Fat</b> 2g	<b>2%</b>	<b>Total Carbohydrate</b> 26g	<b>9%</b>		
Serving Size 2 slices (56g) Servings Per Container 10	Saturated Fat 0.5g	<b>3%</b>	Dietary Fiber 2g	<b>8%</b>	Calories: 2,000 2,500	
	Trans Fat 0.5g		Sugars 1g			
<b>Calories</b> 140 Calories from Fat 15	<b>Cholesterol</b> 0mg	<b>0%</b>	<b>Protein</b> 4g		Total Fat	
	<b>Sodium</b> 280mg	<b>12%</b>			Sat Fat	
	Vitamin A 0%	•	Vitamin C 0%	•	Cholesterol	
	Thiamin 15%	•	Riboflavin 8%	•	Sodium	
			Calcium 6%	•	Total Carbohydrate	
			Niacin 10%	•	Dietary Fiber	
			Iron 6%		Calories per gram: Fat 9 • Carbohydrate 4 • Protein 4	

**L8. Are cellophane windows on bags or boxes considered as space available to bear labeling?**

*Answer:* If the window is used for any labeling, including promotional stickers, the window is considered to be available labeling space. However, if no labeling is present it is not considered to be available space.

**L9. If a straw is placed over the back of a juice carton, must that panel be considered space available to bear labeling?**

*Answer:* Yes, however, required label information must be presented in a manner so that it is not obscured. Firms having difficulties in presenting nutrition information on such packages may wish to request a special allowance pursuant to 21 CFR 101.9(g)(9) by writing to the Office of Nutrition, Labeling, and Dietary Supplements, HFS-800, 5100 Paint Branch Pkwy., College Park MD 20740.

<b>Nutrition Facts</b>	
Serving Size 1 cup (245 g)	
Servings Per Container 2	
Amount Per Serving	
Calories 60	Calories from Fat 10
% Daily Value*	
<b>Total Fat</b> 1g	<b>2%</b>
<b>Sodium</b> 800mg	<b>33%</b>
<b>Total Carbohydrate</b> 10g	<b>3%</b>
Dietary Fiber 0g	4%
<b>Protein</b> 5g	
Vitamin A 20% • Vitamin C 4% • Iron 4%	
Not a significant source of saturated fat, trans fat, cholesterol, sugars, or calcium	
* Percent Daily Values are based on a 2,000 calorie diet. Your Daily Values may be higher or lower depending on your calorie needs:	
	Calories: 2,000 2,500
Total Fat	Less than 65g 80g
Sat Fat	Less than 20g 25g
Cholesterol	Less than 300mg 300mg
Sodium	Less than 2,400mg 2,400mg
Total Carbohydrate	300g 375g
Dietary Fiber	25g 30g
Calories per gram:	
Fat 9 • Carbohydrate 4 • Protein 4	

**L10. If the nutrients that are required to be included on the Nutrition Facts label are present at 0 grams per serving, when can they be summarized in a sentence? Can more than one nutrient be included in the sentence?**

*Answer:* The nutrients listed below may be omitted from the list of nutrients and included in a single sentence when present at “zero” levels in a food. This is done by putting the label statement (“Not a significant source of \_\_\_\_\_”) immediately below the listing of vitamins A and C, calcium, and iron. When the statement “Not a significant source of \_\_\_\_\_” is used for more than one nutrient, nutrients must be listed in the order in which they would have been listed in the regular format (e.g., “Not a significant source of calories from fat, saturated fat, trans fat, cholesterol, dietary fiber, sugars, vitamin A, vitamin C, calcium and iron”). The footnote can be used, with any format, to list one or more of the following nutrients: (21 CFR 101.9(c))

- (1) Saturated fat content information is required if claims are made about fat, fatty acid, or cholesterol content or if “calories from saturated fat” is declared.
- (2) Trans fat information is required if claims are made about fat, fatty acid or cholesterol content.
- (3) Cholesterol content is required if claims are made about fat, fatty acids or cholesterol content.
- (4) Sugars content information is required if claims are made about sweeteners, sugars or sugar alcohols.

<i>Nutrient</i>	<i>Level per serving</i>	<i>Label statement</i>
Calories from fat 21 CFR 101.9(c)(1)(ii)	Less than 0.5 g fat	“Not a significant source of calories from fat”
Saturated fat 21 CFR 101.9(c)(2)(i)	Less than 0.5 g of total fat <sup>(1)</sup>	“Not a significant source of saturated fat”
Trans fat 21 CFR 101.9(c)(2)(ii)	Less than 0.5 g of total fat <sup>(2)</sup>	“Not a significant source of trans fat”
Cholesterol 21 CFR 101.9(c)(3)	Less than 2 mg <sup>(3)</sup>	“Not a significant source of cholesterol”
Dietary fiber 21 CFR 101.9(c)(6)(i)	Less than 1 g	“Not a significant source of dietary fiber”
Sugars 21 CFR 101.9(c)(6)(ii)	Less than 0.5 g <sup>(4)</sup>	“Not a significant source of sugars”
Vitamins A and C, calcium, and iron 21 CFR 101.9(c)(8)(iii)	Less than 2% of RDI	“Not a significant source of _____” (listing the vitamins or minerals omitted)

**L11. A package design firm asked about the option of reversing the Nutrition Facts label copy as white type out of a dark colored background on the grounds that reverse copy, with the appropriate size and color contrast, can be as readable as positive type.**

*Answer:* Part 101.9(d)(1)(i) states that the nutrition information “shall be all black or one color type, printed on a white or other neutral contrasting background whenever practical.” This does not prohibit reverse print or use of other colors. However, if reverse type is used, FDA expects that any impairment in readability resulting from such a technique will be compensated for by use of other graphic techniques to improve readability, such as increased type size. Reverse printing is not permitted as a form of highlighting under *21 CFR 101.9(d)(1)(iv)* because it would interfere with the consistent look of the label.

**L12. Is it necessary to include a calorie conversion footnote which states that fat, carbohydrate, and protein furnish 9, 4, and 4 calories per gram, respectively?**

*Answer:* No, the use of that footnote is optional. *21 CFR 101.9(d)(10)*

**L13. Do the values under % Daily Value need to be aligned under the heading as specified in 21 CFR 101.9(d)(7)(ii) or aligned to the far right side of the column (i.e., right justified) as shown in the format examples?**

*Answer:* The listing of percent of the Daily Values needs to be in a column aligned under the heading and can be either centered or right justified.

**L14. We make bean curd (tofu) hot dogs that are packaged in a film that conforms to the shape of the product. Can I place nutrition labeling on the film, or must I use a paper strip label?**

*Answer:* The Nutrition Facts label can be placed on the film package provided that the color contrast of the print and the indentations made by the product do not prevent consumers from being able to read the information at the point of purchase.

**L15. Can we use a continuous print label that would result in the Nutrition Facts label being cut off at an odd spot, with the bottom of the label at the top of the package, and the top of the label near the bottom?**

*Answer:* No. However, if a continuous print label includes one uncut Nutrition Facts label it would be acceptable.

**L16. Can the Nutrition Facts label be printed on a sticker and affixed to a package?**

*Answer:* Yes, as long as the sticker adheres to the product under the intended storage conditions. Some companies use generic cartons or bags and affix product specific labeling.

## Specific Label Formats

### Bilingual Format

#### L17. On labels that have two languages, may nutrition information be provided in one bilingual Nutrition Facts label?

*Answer:* When nutrition labeling must be presented in a second language, the nutrition information may be presented in separate nutrition labels for each language or in one label with the second language, translating all required information, following that in English. Numeric characters that are identical in both languages need not be repeated.

21 CFR 101.9(d)(14)

<b>Nutrition Facts/Datos de Nutrición</b>			
Serving Size/Tamaño por Ración 1 cup/1 taza (228 g)			
Servings Per Container/raciones por Envase 2			
<b>Amount Per Serving/Cantidad por Ración</b>			
<b>Calories/Calorías</b> 260		Calories from Fat/Calorías de Grasa 120	
			<b>% Daily Value*/ Valor Diario*</b>
<b>Total Fat/Grasa Total</b> 13g			<b>20%</b>
Saturated Fat/Grasa Saturada 5g			<b>25%</b>
Trans Fat/Grasa Trans 2g			
<b>Cholesterol/Colesterol</b> 30mg			<b>10%</b>
<b>Sodium/Sodio</b> 660mg			<b>28%</b>
<b>Total Carbohydrate/Carbohidrato Total</b> 31g			<b>11%</b>
Dietary Fiber/Fibra Diética 0g			<b>0%</b>
Sugars/Azúcares 5g			
<b>Protein/Proteínas</b> 5g			
Vitamin A/Vitamina A 4%	•	Vitamin C/Vitamina C 2%	
Calcium/Calcio 15%	•	Iron/Hierro 4%	
* Percent Daily Values are based on a 2,000 calorie diet. Your Daily Values may be higher or lower depending on your calorie needs:		* Los porcentajes de Valores Diario están basados en una dieta de 2,000 calorías. Sus Valores Diarios pueden ser mayores o menores dependiendo de sus necesidades calóricas:	
	Calories/Calorías:	2,000	2,500
Total Fat/Grasa Total 13g	Less than/Menos de	65g	80g
Saturated Fat/Grasa Saturada 5g	Less than/Menos de	20g	25g
Cholesterol/Colesterol 30mg	Less than/Menos de	300mg	300mg
Sodium/Sodio 660mg	Less than/Menos de	2,400mg	2,400mg
Total Carbohydrate/Carbohidrato Total 31g		300g	375g
Dietary Fiber/Fibra Diética 0g		25g	30g

**L18. I call my product Frijoles Pintos. Is bilingual labeling required? What about salsa?**

*Answer:* When an accepted common or usual name for a food is in a language other than English (e.g., salsa, chili con carne, croissants, rigatoni), use of this common or usual name does not necessitate dual language declaration. However, if the name of the food is intended to bring the article to the attention of a person who does not speak English (e.g., Frijoles Pintos), all required information must be presented in the foreign language.

21 CFR 101.15(c)

**Variety Packs/Aggregate Format**

**L19. How should variety packs (e.g., breakfast cereals) display the nutrition information?**

*Answer:* When a package contains two or more packaged foods that are intended to be eaten individually, such as a variety pack of breakfast cereals or when packages may be used interchangeably for the same type of food, such as round ice cream containers, the manufacturer may choose to include separate Nutrition Facts labels for each food product, or may use an aggregate

Nutrition Facts label. 21 CFR 101.9(d)(13)(i) & (ii)

<b>Nutrition Facts</b>	Wheat Squares Sweetened	Corn Flakes Not Sweetened	Mixed Grain Flakes Sweetened
Serving Size 1 box	(35g)	(19g)	(27g)
Servings Per Container	1	1	1
<b>Amount Per Serving</b>			
<b>Calories</b>	130	70	100
Calories from Fat	0	0	0
	<b>% Daily Value*</b>	<b>% Daily Value*</b>	<b>% Daily Value*</b>
<b>Total Fat</b>	0g <b>0%</b>	0g <b>0%</b>	0g <b>0%</b>
Saturated Fat	0g <b>0%</b>	0g <b>0%</b>	0g <b>0%</b>
Trans Fat	0g	0g	0g
<b>Cholesterol</b>	0mg <b>0%</b>	0mg <b>0%</b>	0mg <b>0%</b>
<b>Sodium</b>	0mg <b>0%</b>	200mg <b>8%</b>	120mg <b>5%</b>
<b>Potassium</b>	125mg <b>4%</b>	25mg <b>1%</b>	30mg <b>1%</b>
<b>Total Carbohydrate</b>	29g <b>10%</b>	17g <b>6%</b>	24g <b>8%</b>
Dietary Fiber	3g <b>12%</b>	1g <b>4%</b>	1g <b>4%</b>
Sugars	8g	6g	13g
<b>Protein</b>	4g	1g	1g
	<b>Vitamin A 0%</b>	<b>10%</b>	<b>10%</b>
	<b>Vitamin C 0%</b>	<b>15%</b>	<b>90%</b>
	<b>Calcium 0%</b>	<b>0%</b>	<b>0%</b>
	<b>Iron 10%</b>	<b>6%</b>	<b>20%</b>
	<b>Thiamin 10%</b>	<b>15%</b>	<b>20%</b>
	<b>Riboflavin 30%</b>	<b>15%</b>	<b>20%</b>
	<b>Niacin 30%</b>	<b>15%</b>	<b>20%</b>
	<b>Vitamin B<sub>6</sub> 30%</b>	<b>15%</b>	<b>20%</b>
*Percent Daily Values are based on a 2,000 calorie diet. Your Daily Values may be higher or lower depending on your calorie needs:			
	Calories: 2,000	2,500	
Total Fat	Less than 65g	80g	
Sat Fat	Less than 20g	25g	
Cholesterol	Less than 300mg	300mg	
Sodium	Less than 2,400mg	2,400mg	
Total Carbohydrate	300g	375g	
Dietary Fiber	25g	30g	



**L20. We produce a cookie assortment containing various percentages of 6 different cookies. What nutrition format should be used?**

*Answer:* The manufacturer may choose to use: (1) a separate Nutrition Facts label for each variety of cookie in the package, (2) an aggregate label (i.e., a single Nutrition Facts label including nutrient content information and % DVs in separate columns for each variety), or, (3) if it is likely that one person would eat an assortment of the cookies at the same time, a composite label that provides one set of nutrition information based on a weighted average of all of the cookies in the assortment. 21 CFR 101.9(h), 21 CFR 101.9(d)(13)

**L21. I use a single box to package a variety of different products (e.g., cherry pie, apple pie or cheese cake, etc.). The box is partially pre-labeled (i.e., it bears nutrition labeling in the aggregate format for all possible products). When the product is packaged, I print the identity statement for the food on the PDP. Must the Nutrition Facts label be marked or highlighted at the time of packaging to indicate which product is in the package?**

*Answer:* No, the statement of identity on the PDP along with the statement of identity above each column of nutrient values in the aggregate Nutrition Facts label will provide adequate information for the consumer to determine which nutritional values in the aggregate label apply to the contents of the package. 21 CFR 101.9(d)(13)(i)

<b>Nutrition Facts</b>		
Serving Size 1 Cup (35g)		
Servings Per Container 10		
Amount Per Serving	with 1/2 cup	
	Cereal	Skim milk
<b>Calories</b>	130	170
Calories from Fat	0	0
<b>% Daily Value**</b>		
<b>Total Fat</b> 0g*	<b>0%</b>	<b>0%</b>
Saturated Fat 0g	<b>0%</b>	<b>0%</b>
Trans Fat 0g		
<b>Cholesterol</b> 0mg	<b>0%</b>	<b>0%</b>
<b>Sodium</b> 200mg	<b>8%</b>	<b>11%</b>
<b>Total Carbohydrate</b> 30g	<b>10%</b>	<b>12%</b>
Dietary Fiber 4g	<b>16%</b>	<b>16%</b>
Sugars 18g		
<b>Protein</b> 3g		
Vitamin A	25%	25%
Vitamin C	25%	25%
Calcium	0%	15%
Iron	10%	10%
* Amount in cereal. One half cup skim milk contributes an additional 40 calories, 65mg sodium, 6g total carbohydrate (6g sugars), and 4g protein.		
**Percent Daily Values are based on a 2,000 calorie diet. Your Daily Values may be higher or lower depending on your calorie needs:		
	Calories:	2,000      2,500
Total Fat	Less than	65g      80g
Sat Fat	Less than	20g      25g
Cholesterol	Less than	300mg      300mg
Sodium	Less than	2,400mg      2,400mg
Total Carbohydrate		300g      375g
Dietary Fiber		25g      30g
Calories per gram:		
Fat 9 • Carbohydrate 4 • Protein 4		

**As Packaged/As Prepared/Dual Column Format**

**L22. What are the definitions of “as packaged” and “as prepared”?**

*Answer:* “As packaged” refers to the state of the product as it is marketed for purchase. “As prepared” refers to the product after it has been made ready for consumption (e.g., ingredients added per instructions and cooked such as a cake mix that has been prepared and baked or a condensed or dry soup that has been reconstituted).

**L23. If a manufacturer chooses to do so, how may a food be labeled if the labeled food is commonly combined with another food before eating?**

*Answer:* The Nutrition Facts label must state the nutrients in the food “as packaged” (i.e., before consumer preparation). However, manufacturers are encouraged to add a second column of nutrition information showing calories, calories from fat and the % DV for the combination of foods eaten. Quantitative amounts (i.e., g/mg) need only be given for the packaged food. However, as shown in this example, a footnote can be added to indicate the amount of nutrients in the added food. Alternatively, the quantitative amounts of the prepared food may be included immediately adjacent to those for the packaged food (e.g., “Sodium 200 mg, 265 mg”). 21 CFR 101.9(e)

**L24. When a second column of nutrient information is provided, is it necessary to repeat the “serving size” and “servings per container”?**

*Answer:* The dual listing of serving size and servings per container is not required when providing a second column of nutrient information. The only requirement is to list the serving size and servings per container that are based on the Reference Amounts Customarily Consumed (RACC) for the product. 21 CFR 101.9(b)(9) and 21 CFR 101.9(e)

**L25. I have a recipe on my package which calls for 250% of the RACC of my product for each serving of the food created using the recipe. Must I use dual declaration for the nutrition label?**

*Answer:* Yes. Section 101.9(b)(11) states that if the product is promoted on the label or labeling for a use that differs in quantity from the RACC by 200% or greater, dual declaration would be required. FDA considers recipes on the label as “promoting” a use of the food. The regulations (21 CFR 101.9(b)(11)) specifically exempt bulk products used primarily as ingredients (e.g., flour, sugar, oils) or traditionally used for multi-purposes (e.g., eggs, butter) from dual declaration requirements.

**L26. We want to use dual declaration for cereals. Do we have to include the 240 mL RACC, a one cup serving, for the added milk, or can we use 1/2 or 1/4 cup?**

*Answer:* Such a label would have two columns with a heading “Cereal” and “Cereal with 1/2 cup (or 1/4 cup) \_\_\_\_\_ milk” where the blank is filled in with the type of milk. 21 CFR 101.9(e) (See figure on page 42)

**L27. We have a condensed “cream of \_\_\_ soup”. Should we do dual declaration?**

*Answer:* Dual declaration is optional. 21 CFR 101.9(e)

**L28. If a recipe is placed on the label of a product, does the nutrient profile of the recipe have to be included on the label?**

*Answer:* Only if the recipe calls for 200% or more of the RACC of the product for each serving of the food created by the recipe. When the recipe calls for an amount less than 200% of the RACC, such information could be voluntarily listed. However, nutrition information for a specific recipe may be presented outside of the Nutrition Facts label. 21 CFR 101.9(b)(11)

**L29. If a manufacturer chooses to do so, what is an example of the Nutrition Facts label for a food requiring further preparation by the consumer?**

*Answer:* See example to right. However, when the nutrient values in the column for the product prepared according to package directions would be identical to the column for the product as packaged (e.g., the only ingredients added during preparation are ingredients such as water), manufacturers may omit the second column and include the amount made as part of the serving size declaration. For example, a dry beverage mix could declare: “Serving Size: 1 tsp. dry powder (4 g)(makes 1 cup prepared).” 21 CFR 101.9(b)(7)(v), 21 CFR 101.9(e)(5)

**Simplified Format**

**L30. Is there a Nutrition Facts format for a food in which most nutrients are present in insignificant amounts?**

*Answer:* A simplified Nutrition Facts label may be used if at least eight of the following nutrients are present in insignificant amounts: Calories, total fat, saturated fat, trans fat, cholesterol, sodium, total carbohydrate, dietary fiber, sugars, protein, vitamin A, vitamin C, calcium and iron (slightly different rules for labeling foods intended for children less than 2 years). The five core nutrients, shown in bold in the adjoining example, must always appear on all Nutrition Facts labels regardless of amounts present in the food. In addition,

<b>Nutrition Facts</b>			
Serving Size 1/12 package (44g, about 1/4 cup dry mix) Servings Per Container 12			
Amount Per Serving	Mix	Baked	
<b>Calories</b>	190	280	
Calories from Fat	45	140	
<b>% Daily Value</b>			
<b>Total Fat 5g*</b>	<b>8%</b>	<b>24%</b>	
Saturated Fat 2g	<b>10%</b>	<b>13%</b>	
Trans Fat 0g			
<b>Cholesterol 0 mg</b>	<b>0%</b>	<b>23%</b>	
<b>Sodium 300mg</b>	<b>13%</b>	<b>13%</b>	
<b>Total</b>			
<b>Carbohydrate 34g</b>	<b>11%</b>	<b>11%</b>	
Dietary Fiber 0g	<b>0%</b>	<b>0%</b>	
Sugars 18g			
<b>Protein 2g</b>			
Vitamin A	0%	0%	
Vitamin C	0%	0%	
Calcium	6%	8%	
Iron	2%	4%	
*Amount in Mix			
**Percent Daily Values are based on a 2,000 calorie diet. Your Daily Values may be higher or lower depending on your calorie needs:			
	Calories:	2,000	2,500
Total Fat	Less than	65g	80g
Sat Fat	Less than	20g	25g
Cholesterol	Less than	300mg	300mg
Sodium	Less than	2,400mg	2,400mg
Total Carbohydrate		300g	375g
Dietary Fiber		25g	30g
Calories per gram: Fat 9 • Carbohydrate 4 • Protein 4			



any of the nutrients required on the full Nutrition Facts label that are naturally present or are added to the food must be declared on the simplified Nutrition Facts label.

21 CFR 101.9(f) - List of nutrients; 101.9(f)(1) - “Insignificant” defined; 101.9(c) - “Insignificant” levels listed for nutrients

<b>Nutrition Facts</b>	
Serving Size 1 can	
Amount Per Serving	
<b>Calories</b> 140	
	% Daily Value*
<b>Total Fat</b> 0g	<b>0%</b>
<b>Sodium</b> 20mg	<b>1%</b>
<b>Total Carbohydrate</b> 36g	<b>12%</b>
Sugars 36g	
<b>Protein</b> 0g	
*Percent Daily Values are based on a 2,000	

**L31. What are insignificant amounts of nutrients?**

*Answer:* These are the amounts that are permitted to be shown as zero on the Nutrition Facts label (e.g., less than 5 calories may be expressed as 0 calories) except that for total carbohydrate, dietary fiber, and protein, it is the amount that can be declared as “less than 1 g” on the Nutrition Facts label. 21 CFR 101.9(c)

**L32. When I use the simplified format, when is the statement “Not a significant source of \_\_\_\_\_” required?**

*Answer:* This statement, which must list all nutrients required by the full format that are present at insignificant amounts, must be included when: (1) nutrition claims are made; or (2) vitamins and minerals are added; or (3) naturally occurring nutrients that are not required on the full format (e.g., potassium) are voluntarily declared. 21 CFR 101.9(f)(4)

**L33. If a product qualifies for the simplified format, but the company wants to make a claim about a required or voluntary nutrient, can it still use the simplified format?**

*Answer:* Yes. However, as noted in the previous question and answer, when a claim is made, the statement “Not a significant source of \_\_\_\_\_” (with the blank filled in with the name(s) of any nutrient(s) identified in 21 CFR 101.9(f) and calories from fat that are present in insignificant amounts) must be included at the bottom of the nutrition label. 21 CFR 101.9(f)(4)

**L34. When should a statement be used on simplified format labels to list nutrients present at insignificant amounts?**

*Answer:* A “simplified format label” must include a statement listing “zero” level nutrients when nutrients are added to the food or voluntarily declared on the Nutrition Facts label, and when claims are made on the label. In this example, the manufacturer voluntarily lists polyunsaturated and monounsaturated fat, and therefore must add the statement “Not a significant source of \_\_\_\_\_” with the blank filled in by the names of nutrients present at insignificant levels. 21 CFR 101.9(f)(4)

**L35. When the simplified format is used, can nutrients that are not required to be listed and that are present at insignificant amounts be listed voluntarily (e.g., calories from fat, saturated fat, trans fat, cholesterol, dietary fiber, sugars, vitamin A, vitamin C, calcium and iron)?**

*Answer:* The intent of the simplified format was to minimize the amount of information required to be on the label. While the agency discourages the listing of optional nutrients, present at insignificant amounts, in the simplified format, the regulations do not prohibit such listing. When non required nutrients (e.g., calories from fat, saturated fat, trans fat, cholesterol, dietary fiber, sugars, vitamin A, vitamin C, calcium or iron) are voluntarily listed as zero, the footnote required by 21 CFR 101.9(f)(4) is not required.

<b>Nutrition Facts</b>	
Serving Size 1 Tbsp (14 g)	
Servings Per Container 64	
Amount Per Serving	
<b>Calories</b> 130	Calories from Fat 130
	% Daily Value*
<b>Total Fat</b> 14g	<b>22%</b>
<b>Saturated Fat</b> 2g	<b>10%</b>
<i>Trans</i> Fat 2g	
Polyunsaturated Fat 4g	
Monounsaturated Fat 6g	
<b>Sodium</b> 0mg	<b>0%</b>
<b>Total Carbohydrate</b> 0g	<b>0%</b>
<b>Protein</b> 0g	
Not a significant source of cholesterol, dietary fiber, sugars, vitamin A, vitamin C, calcium, and iron.	
* Percent Daily Values are based on a 2,000 calorie diet.	

**L36. If a product qualifies to use the simplified format but the manufacturer elects to use the full format and list the insignificant level of nutrient(s) as zero, can the footnote still be shortened?**

*Answer:* No, since use of the simplified format is optional all required information must be presented when the full format is used. 21 CFR 101.9(d)(9)

**L37. How do I use the “Not a significant source of \_\_\_\_\_” in the tabular format?**

*Answer:* When the full format is presented in a tabular display, the statement “Not a significant source of \_\_\_\_\_” should be placed beneath the vitamins and minerals and be separated by a hairline. When the simplified format is presented in a tabular display, the statement should be separated by a bar under the nutrients declared.

**L38. What is the correct type size for the “Not a significant source of \_\_\_\_\_” statement?**

*Answer:* 6 point

**L39. Can the simplified format be used regardless of the amount of available label space?**

*Answer:* Yes. The nutrient content of the food, not available label space, is the determining factor. 21 CFR 101.9(f)

**L40. When the simplified format is used, what is the required type size?**

*Answer:* The type size and layout requirements are the same as that required for the full format. 21 CFR 101.9(f)(5)

**L41. Is the entire footnote used with the standard format, which lists DVs for 2,000 and 2,500 calorie diets, required to be used on the simplified format for intermediate sized packages with 40 or less square inches of available space?**

*Answer:* No. The simplified format only requires the statement “Percent Daily Values are based on a 2,000 calorie diet” regardless of the size of the package. If the term “Daily Value” is abbreviated in the heading as “DV,” the statement must indicate that “DV” means “Daily Value” (e.g., “Percent Daily Values (DV) are based on a 2,000 calorie diet”). 21 CFR 101.9(f)(5)

## **Trans Fat Labeling**

**L42. Why is FDA requiring that trans fatty acids be listed in nutrition labeling?**

*Answer:* FDA is requiring that trans fatty acids be listed in nutrition labeling in response to a petition from the Center for Science in the Public Interest and to published human studies that show that intake of trans fatty acids, similar to the intake of saturated fatty acids, increases low density lipoprotein-cholesterol (LDL-C) (“bad cholesterol”) in the blood. An elevated LDL-C increases the risk of developing coronary heart disease. Reports published by the Institute of Medicine of the National Academy of Sciences (IOM/NAS) and the Federal government have recommended that Americans limit their intake of trans fat and other cholesterol-raising fats while consuming a

nutritionally adequate diet. For Americans to follow these recommendations, they must know the amount of trans fatty acids in the individual foods that they eat. Therefore, FDA is requiring that this information be provided in nutrition labeling to assist consumers in maintaining healthy dietary practices. (68 FR 41434, July 11, 2003)

**L43. How is trans fat defined for labeling purposes?**

**Answer:** The Agency's regulatory chemical definition of trans fatty acids is "all unsaturated fatty acids that contain one or more isolated double bonds (i.e. non conjugated) in a trans configuration." Trans vaccenic acid, a trans fatty acid with a single double bond, and other trans fatty acids of ruminant origin with either a single double bond or nonconjugated double bonds are included in this definition. Trans fatty acids with conjugated bonds are not included because they do not meet the Agency's definition. Thus, trans fatty acids, regardless of origin, that meet the above definition are to be included in the label declaration of trans fat. Further, using FDA's regulatory chemical definition, the categories "trans fatty acids" and "conjugated fatty acids" are mutually exclusive. The definition of trans fatty acids, excluding fatty acids with conjugated double bonds, is consistent with the way that cis isomers of polyunsaturated fatty acids are defined. (68 FR 41434 at 41461, July 11, 2003.)

<b>Nutrition Facts</b>	
Serving Size 1 cup (228g) Servings Per Container 12	
<b>Amount Per Serving</b>	
<b>Calories</b> 260	Calories from Fat 120
% Daily Value	
<b>Total Fat</b> 13g	<b>20%</b>
Saturated Fat 5g	<b>25%</b>
Trans Fat 2g	
<b>Cholesterol</b> 30mg	<b>10%</b>
<b>Sodium</b> 660mg	<b>28%</b>
<b>Total Carbohydrate</b> 31g	<b>10%</b>
Dietary Fiber 0g	<b>0%</b>
Sugars 5g	
<b>Protein</b> 5g	
Vitamin A 4%	• Vitamin C 2%
Calcium 15%	• Iron 4%
*Percent Daily Values are based on a 2,000 calorie diet. Your Daily Values may be higher or lower depending on your calorie needs:	
	Calories: 2,000    2,500
Total Fat	Less than 65g    80g
Sat Fat	Less than 20g    25g
Cholesterol	Less than 300mg    300mg
Sodium	Less than 2,400mg    2,400mg
Total Carbohydrate	300g    375g
Dietary Fiber	25g    30g
Calories per gram:	
Fat 9	• Carbohydrate 4    • Protein 4

**L44. Do trans fatty acids need to be listed when mono- and poly-unsaturated fatty acids are not listed?**

**Answer:** Yes. The listing of trans fatty acids is mandatory even when mono- and polyunsaturated fatty acids are not listed. 21 CFR 101.9(c), (c)(2)(ii), (c)(2)(iii), and (c)(2)(iv).

**L45. How should trans fatty acids be listed?**

**Answer:** Trans fatty acids should be listed as "Trans fat" or "Trans" on a separate line under the listing of saturated fat in the Nutrition Facts label (see figure). The word "trans" may be italicized to indicate its Latin origin. Trans fat content must be expressed as grams per serving to the nearest 0.5-gram increment below 5 grams and to the nearest gram above 5 grams. If a serving contains less than 0.5 gram, the content, when declared, must be expressed as "0 g." (21 CFR 101.9(c)(2)(ii)).

**L46. If a serving contains less than 0.5 gram of trans fat, when would "0 g" of trans fat not have to be declared?**

**Answer:** For conventional food products (those food products other than dietary supplements), declaration of "0 g" of trans fat is not required for such products that contain less than 0.5 g of total fat in a serving and no claims are made about fat, fatty acid or cholesterol content. If trans fat is not listed, the statement "Not a significant source of trans fat" may be placed at the bottom of the table of nutrient values in lieu of declaring "0 g" of trans fat. If these claims are present, then the statement "Not a significant source of trans fat" is not an option and the declaration of "0 g" of trans fat is required. 21 CFR 101.9(c)(2)(ii)

#### **L47. Why is there no % DV for trans fat?**

*Answer:* Although the updated Nutrition Facts label will now list the amount of trans fat in a product, there is no % DV for trans fat. While scientific reports have confirmed the relationship between trans fat and an increased risk of CHD, none has recommended an amount of trans fat that FDA could use to establish a DV. Without a DV, a % DV cannot be calculated. As a result, trans fat will be listed with only a gram amount. *21 CFR 101.9(d)(7)(ii)*

#### **L48. Is it possible for a food product to list the amount of trans fat as 0 g on the Nutrition Facts label if the ingredient list indicates that it contains “partially hydrogenated vegetable oil?”**

*Answer:* Yes. Food manufacturers are allowed to list amounts of trans fat with less than 0.5 gram ( $\frac{1}{2}$  g) as 0 (zero) on the Nutrition Facts label. As a result, consumers may see a few products that list 0 gram trans fat on the label, while the ingredient list will have “shortening” or “partially hydrogenated vegetable oil” on it. This means the food contains very small amounts (less than 0.5 g) of trans fat per serving.

#### **L49. What about nutrient content claims for trans fat?**

*Answer:* Nutrient content claims are statements that are made on the food label package that indicate that the product contains a range from free to high of the amount of a specific nutrient. Examples: “Low Fat” and “High in Fiber.” At this time, FDA has insufficient scientific information to establish NCCs for trans fat. Such claims are permitted, however, for saturated fat and cholesterol.

#### **L50. What other regulations about nutrition labeling of trans fatty acids is FDA considering?**

*Answer:* The Food and Drug Administration (FDA) issued an advance notice of proposed rulemaking (ANPRM) in the Federal Register (Food Labeling: Trans Fatty acids in Nutrition Labeling; Consumer Research to Consider Nutrient Content and Health Claims and Possible Footnote or Disclosure Statements; 68 FR 41507; July 11, 2003) to solicit information and data that potentially could be used to establish new NCCs about trans fat, to establish qualifying criteria for trans fat in current NCCs for saturated fat and cholesterol, lean and extra lean claims, and health claims that contain a message about cholesterol raising fats, and, in addition, as disclosure and disqualifying criteria to help consumers make heart-healthy food choices. The agency also requested comments on whether to consider statements about trans fat, either alone or in combination with saturated fat and cholesterol, as a footnote in the Nutrition Facts label or as a disclosure statement in conjunction with claims to enhance consumers' understanding about such cholesterol-raising lipids and how to use the information to make healthy food choices. Information and data obtained from comments and from consumer studies conducted by FDA may be used to help draft a proposed rule that would establish criteria for certain nutrient content or health claims or require the use of a footnote, or other labeling approach, about one or more cholesterol-raising lipids in the Nutrition Facts label to assist consumers in maintaining healthy dietary practices.

## Miscellaneous

### **L51. If we nutrition label in good faith, will FDA take legal action involving small mistakes?**

*Answer:* FDA is unlikely to take regulatory action for minor errors. However, such errors should be corrected during the next printing of labels.

### **L52. When are point-of-purchase materials considered labeling?**

*Answer:* Always.

### **L53. I have tried all the available format options, but without some modification I can not make them work on my label, what can I do?**

*Answer:* Under 21 CFR 101.9(g)(9), FDA may permit alternative means of compliance or additional exemptions to deal with special situations. Firms in need of special allowances should make their request in writing to the Office of Nutrition, Labeling, and Dietary Supplements, HFS-800, 5100 Paint Branch Pkwy., College Park, MD 20740. The letter should: (1) specify that you are requesting an exemption or special provision under 21 CFR 101.9(g)(9), (2) identify the particular product(s) that are the subject of the request, (3) state the reason(s) why it is technologically infeasible or impracticable to adhere to the regulations for such products, and (4) identify the proposed alternative procedure. If possible, include an example of the proposed label(s).

### **L54. Are mail order sales covered by the food labeling laws?**

*Answer:* The same labeling laws apply to all categories of retail sale, including mail orders. Foods sold by mail order must be fully labeled.

### **L55. Is it permissible to use stickers to make changes in labeling?**

*Answer:* Correcting label mistakes in any manner is acceptable if the final label is correct and complies with all regulations at the time of retail sale. The stickers should not cover other mandatory labeling, and should adhere tightly.

### **L56. Does FDA approve labels before printing?**

*Answer:* No, it is the responsibility of the manufacturer or importer of a food to comply with current food labeling regulations.

## Serving Size

### *Serving Size/Reference Amounts Customarily Consumed (RACCs) and Food Categories*

### **L57. I am trying to determine the appropriate serving size and number of servings to list on the label of my food product. How do I start, and what steps should I follow?**

*Answer:* Manufacturers must use the information provided in the regulation to determine a specific serving size for their products. The process consists of three steps:

1. Locate the appropriate food category and Reference Amount Customarily Consumed (RACC) for your product in the two tables in Section 101.12(b) of the food labeling regulations. Table 1 is for infant and toddler foods. Table 2 is foods for the general population. FDA



established RACCs for 139 food product categories, and these values represent the amount of food customarily consumed at one eating occasion. Most of the RACCs are for foods in a ready-to-eat form. If your product in the form in which it is sold (i.e., “as packaged”), does not have a RACC in the tables, then you must generate an appropriate RACC for your product using *21 CFR 101.12(c)* for products that require further preparation, (d) for imitation foods, (e) for aerated foods, and (f) for products that represent two or more foods packaged and presented to be consumed together.

The first important step in establishing an appropriate serving size is to determine if your product is in a single serving container. Products packaged and sold in small units are required to be labeled as single-serving containers; the specifications for these products are described in *21 CFR 101.9(b)(6)*. If your product is a single serving, it must be labeled in accordance with the labeling requirements for single-serving containers in *21 CFR 101.9(b)(6)*.

2. Determine the serving size for your multi-serving product using the RACC for the product (*21 CFR 101.9(b)(2)*, (3), and (4)).

The serving size is expressed as a common household measure followed by the equivalent metric quantity in parenthesis (e.g., “1/2 cup (112 g)”). Acceptable household measures are listed in order of appropriate use in *21 CFR 101.9(b)(5)*. Rounding rules for metric quantities and a few additional format options are included in *21 CFR 101.9(b)(7)*.

3. Use the information in *21 CFR 101.9(b)(8)* to determine the number of servings and the appropriate rounding rules for numbers of servings.

**L58. The RACC for a food product is 50 grams, but a single serving of the product weighs 54 grams. Is the nutrition information based on the 50 gram RACC or the actual metric unit?**

*Answer:* The nutrition information on the label is based on the household unit closest to the RACC. In this case it would be based on 54 grams, which would be declared as the weight of the label serving size. The RACC is used as the starting point to determine the serving size for the foods in each product category and to govern claims.

**L59. What is the RACC for partially cooked, packaged pasta products? Table 2 only gives RACCs for prepared and dry pasta.**

*Answer:* The RACC for a partially cooked pasta product is the amount of partially cooked pasta that makes one RACC of cooked pasta (140 grams). *21 CFR 101.12(c)*

**L60. To what category do pickled vegetables belong?**

*Answer:* Pickled vegetables are categorized with “pickles, all types” with a RACC of 30 grams. *21 CFR 101.12(b)*

**L61. What if my product does not have an appropriate food category listing or RACC?**

*Answer:* The agency realizes that the categories in Table 2 “Reference Amounts Customarily Consumed” may not include all foods marketed in the U.S. Therefore, in order to allow manufacturers to provide nutrition information on currently marketed product labels, the manufacturer should write the agency and send in information regarding the primary usage,

amount customarily consumed, and any other information as requested for a petition as discussed in section 21 CFR 101.12(h). FDA will provide a “suggested RACC” for the product that may be used to meet the manufacturer’s immediate needs to nutrition label its products. While the agency will provide a “suggested RACC” so as to allow the manufacturer to nutrition label its products at this time, FDA believes that it will be necessary at a later date to undertake notice and comment rulemaking to formally establish a RACC. Alternatively, the manufacturer or any other interested party may petition FDA at any time to establish a RACC as specified in 21 CFR 101.12(h).

**L62. What “suggested RACCs” have been provided to date?**

**Answer:** The “suggested RACCs” to date are shown below. The labeled serving size for these products would be expressed in a household unit followed by the metric equivalent in parentheses.

Powdered, flavored candy -	15 g
Colored, flavored syrup-filled wax candy -	15 mL -
Ice -	4 ounces -
Dried tomatoes (halved, sliced, minced, bits) -	5 g -
Dried tomatoes in oil (halved, sliced, minced, bits) -	10 g -
Wrappers for eggrolls, dumplings, wontons or potstickers	60 g -
Egg whites (fresh, frozen, dried) -	about 1 large egg -
Sugared eggs, sugared egg yolks -	about 1 large egg -
Flavoring oils -	1 t -
Fruit chutney -	1 T -
Dried yeast -	0.5 g -
Baking cocoa, carob powder -	2 T -
Coconut milk -	1/3 cup -
Dried, e.g., sun-dried tomatoes, dried mushrooms, dried seaweed	10 g -
Dried seaweed sheets -	3 g -
Vegetable spreads (eggplant caponata, olive spread) -	2 T -
Sprouts -	10 g -
Hors d’oeuvres, mini eggrolls, mini pizza rolls and bagel pizzas	85 g

**L63. What terms must be used for the serving size?**

**Answer:** The serving size declaration is made up of two parts: a “household measure term” followed by its metric equivalent in grams (g). For beverages, the household measures may be declared as either fluid ounces, cups, or fractions of a cup with the metric equivalent in milliliters (mL). The examples below show permitted declarations.

Food -	Examples
Cookies -	1 cookie (28 g) or 1 cookie (28 g/1 oz) -
Milk, juices, soft drinks -	8 fl oz (240 mL), or 1 cup (240 mL) for multiserving containers, or the container (e.g., 1 can) for single serving containers
Grated cheese	1 tablespoon (5 g) or 1 tablespoon (5 g/0.2 oz) - 21 CFR 101.9(b)(2), 21 CFR 101.9(b)(5), 21 CFR 101.9(b)(7), and 21 CFR 101.12(b)



**L64. Is a RACC different from a serving size?**

*Answer:* Yes, the RACC is used to derive a serving size for a particular product. The following example shows how to use the RACC to determine the serving size for a 16 oz (454g) pizza:

1. **1st step:** From the RACCs table (21 CFR 101.12(b)), you determine that the RACC for pizza is 140g.

2. **2nd step:** Calculate the fraction of the pizza that is closest to the RACC of 140g (calculations shown for a pie of net weight 16oz/454g pizza): -

$$1/3 \times 454\text{g} = 151\text{g} -$$

$$1/4 \times 454\text{g} = 113\text{g} -$$

Note that 151g is closer than 113g to the RACC for pizza (140g)

3. **3rd step:** The serving size is the fraction closest to the RACC together with the actual gram weight for that fraction of the pizza:

Example: “Serving Size 1/3 pie (151g)”

Therefore, the serving size is “1/3 pizza (151g)” for this example, whereas the RACC is 140g for all pizzas. Note: Sections 101.9(b)(2)(i) (discrete units), 21 CFR 101.9.(b)(2)(ii) (large discrete units), and 21 CFR 101.9(b)(2)(iii) (bulk products) describe how to use the RACC to derive a serving size.

21 CFR 101.12(b)

**L65. The table for RACCs in the regulation contains a column of label statements. What are these and must I use them in declaring a serving size for my food product?**

*Answer:* FDA added a label statement column to the RACC tables to provide manufacturers with examples of how serving sizes could appear on product labels. Exact values were initially provided as part of these statements, but have since been removed because some manufacturers incorrectly believed that the exact label statements were required even if the values were inaccurate for their specific products. Manufacturers should realize that the label statement column is not all inclusive and merely provides a few examples of possible label statements. Manufacturers should use an appropriate household measure and the corresponding metric weight or volume actually measured for their specific product. 21 CFR 101.12(b)

**L66. If the number of units closest to the RACC is midway between two numbers, which should be chosen?**

*Answer:* For serving sizes halfway between two numbers of units, the serving size should be rounded up to the higher value (21 CFR 101.9(b)(5)(ix)). For example, the RACC for cookies is 30 g. If the product is a bag of 12 g cookies, then 2 units weigh 24 g, and 3 units weigh 36 g. Thus, 2.5 cookies would weigh exactly 30 g, and the serving size would be rounded to the next incremental value: “3 cookies (36 g).”

**L67. How is the serving size calculated for the Nutrition Facts label on a biscuit mix product?**

*Answer:* The following example shows how to calculate the serving size for a biscuit mix product and similar products that require further preparation:

1. **1st step:** From the RACC table (21 CFR 101.12(b)), determine that the RACC for biscuits is 55g.

2. **2nd step:** Determine amount of mix needed to make a 55g biscuit.

3. **3rd step:** Determine closest permitted fraction of tablespoon or cup that contains the amount of mix closest to the amount determined in step 2.
4. **4th step:** The serving size is the fraction of a tablespoon or cup of biscuit mix determined in step 3 together with the actual gram weight of that measure of biscuit mix as the serving size.

Use the form “Serving Size \_\_ cup (\_\_ g),” the blanks filled in with correct values for the product. 21 CFR 101.12(b)&(c)

**L68. Is it necessary to reformulate the size of a product such as cookies so that the serving size weighs exactly the RACC (i.e., 30g)?**

**Answer:** It is not necessary to adjust the size of your cookies to fit the RACC. For example, if four cookies weigh 28 grams (and five cookies weigh 35 grams), declare the number of cookies nearest the RACC and label with the exact weight of that number of cookies for the serving size: “Serving size 4 cookies (28g)” or “4 cookies (28g/1 oz).” 21 CFR 101.12(b)

**L69. What fractions must be used to express serving sizes in common household measures?**

**Answer:** For cups, these fractions of a cup are allowed household measures: 1/4 cup, 1/3 cup, 1/2 cup, 2/3 cup, 3/4 cup, 1 cup, 1 1/4 cup, etc. If serving sizes are declared in fluid ounces, declare the serving size in whole numbers (such as 4 fl oz, 5 fl oz, 6 fl oz, etc). For tablespoons, the following fractions of a tablespoon are allowed: 1, 1 1/3, 1 1/2, 1 2/3, 2, and 3 tablespoons. For teaspoons, the fractions of a teaspoon shall be expressed as 1/8, 1/4, 1/2, 3/4, 1, or 2 teaspoons. 21 CFR 101.9(b)(5)(i)

**L70. For foods that are usually cut into pieces before serving, what fractions must be used in the serving size declaration?**

**Answer:** These fractions must be used in serving sizes for foods such as cakes or pies: “1/2”, “1/3”, “1/4”, “1/5”, “1/6”, “1/8”, “1/9”, “1/10”, “1/12” and smaller fractions that can be arrived at by further division by 2 or 3. 21 CFR 101.9(b)(2)(ii)

**L71. For a multi-serving package, what is the serving size for a product that is sliced thinner or thicker than the RACC?**

**Answer:** The slices are treated as “discrete units.” One slice is a single serving if it weighs from 67% to less than 200% of the RACC. Larger slices (weighing more than 200% of RACC) may be declared as a serving if the whole slice can reasonably be eaten at a single-eating occasion. For slices weighing between 50%-67% of the RACC, the serving size may be declared as either one or two slices. For slices weighing less than 50% of the RACC, the serving size is the number of slices closest to the RACC. 21 CFR 101.9(b)(2)(i) and 21 CFR 101.12

**L72. Should a label show “2 1/2 servings”?**

**Answer:** For packages containing from two to five servings, round the number of servings to the nearest 0.5 serving. Examples: “2 servings,” “2.5 servings,” “3 servings,” “3.5 servings,” “4 servings,” “4.5 servings,” and “5 servings.” For packages containing five or more servings, round the number of servings to the nearest whole serving. Examples: “5 servings,” “6 servings,” “7 servings.” Rounding should be indicated by the term “about” (e.g., “about 6 servings”). 21 CFR 101.9(b)(8)

## **Serving Size/As Packaged/As Prepared**

### **L73. My dehydrated mixed dish product has a RACC of 1 cup. Do I declare the serving size as 1 cup or the amount of my product to make 1 cup?**

*Answer:* Although the RACC for mixed dish products is one cup, this amount is for the prepared product. The serving size, however, must represent the product as packaged. This will be the amount of the product, expressed in a household measure, that will make one cup when prepared according to package directions. For example, the serving size for a dry seasoned rice mix will be less than one cup since rice expands during cooking. The gram weight in the parenthetical expression will be the weight of the household measure of dry mix. *21 CFR 101.9(b)(9)*

### **L74. Should the serving size and number of servings per container for unpopped popcorn be based on the prepared product?**

*Answer:* The serving size and servings per container for unpopped popcorn is based on the amount of the product as packaged or purchased needed to make the RACC of the prepared product. A second column of nutrition information based on the as prepared basis may also be presented. *21 CFR 101.9(b)(10)(iii)*

## **Serving Size/Separately Packaged Ingredients**

### **L75. What about the use of fractions of a package to declare serving sizes, such as a 1/8 package of dry mix?**

*Answer:* Generally, serving sizes cannot be declared on the basis of fractions of a package. The exception is for unprepared products where the entire contents of the package mix is used to prepare one large discrete unit that is usually divided for consumption (e.g., cake mix, pizza kit) (*21 CFR 101.9(b)(5)(v)*). For example, a mix for a sheet cake may declare: “1/12 package (40 g/about 1/3 cup mix).” This option is not allowed for other dry mixes or other products. However, a fraction of the package may be used as part of the visual unit of measure when ounces is used as the primary household measure (*21 CFR 101.9(b)(5)(iii)*). For example, the serving size listed on a 1 lb (16 oz) box of spaghetti could be: “2 oz (56 g/ 1/8 box).”

### **L76. Are there special provisions for individually packaged products?**

*Answer:* Single serving containers and individually packaged products within multi-serving containers must use a description of the individual container or package (*21 CFR 101.9(b)(5)(iv)*): “1 can (360 mL)” or “2 boxes (38 g),” and products in discrete units must use a description of the individual unit (*21 CFR 101.9(b)(5)(iv)*): “2 candies (22 g)” or “1 slice (45 g).”

### **L77. What are the options for products consisting of several inner packaged components and intended to be mixed together?**

*Answer:* Products consisting of two or more distinct ingredients or components packaged and presented to be consumed together (e.g., dry macaroni and cheese mix, cake and muffin mixes with separate ingredient packages, pancakes and syrup) may declare serving size and nutrition information either: (a) for each component or (b) as a composite. For products where one of the components is represented as the main ingredient, there are

provisions for representing the amount of the main ingredient and proportioned minor ingredients (21 CFR 101.9(b)(5)(i)-(iii), CFR 21 101.9(b)(2)(i)(H)): “2 pancakes with syrup (160 g)” or alternatively “2 pancakes (110 g)” and either “syrup for 2 pancakes (50 g)” or “2 tbsp syrup (50 g)” if 50 g of syrup makes 2 tbsp. In addition, these products may also use ounces (21 CFR 101.9(b)(5)(vii)): “4 oz (112 g/about 2/3 cup macaroni and 2 tbsp dry cheese mix)” or alternatively “3 oz dry macaroni (84 g/about 2/3 cup)” and “1 oz dry cheese mix (28 g/about 2 tbsp).”

**L78 How do we state the serving size for peanuts with shells?**

*Answer:* The RACC for nuts is 30 grams edible portion. The serving size for peanuts with shells would be the household measure closest to 30 grams of nuts without shells. In order to reduce consumer confusion regarding the serving size, a clarifying statement can be used. For example, the serving size statement for your product might read: “1/2 cup nuts without shells (30 g/about 1 cup nuts with shells).”

**L79. Is the serving size for all pickled vegetables based on a drained weight basis? Is it the same for canned vegetables?**

*Answer:* The serving size for pickled vegetables is based on the drained weight of the product because the liquid is not usually consumed with these type products. For canned vegetables, the liquid is included in the determination of serving size. 21 CFR 101.9(b)(8)(ii), 21 CFR 101.9(b)(9)

## **Serving Size/Dual Column Allowances**

**L80. If a product is sold both in the U.S. and exported, can the nutrition information also be declared “per 100 grams” or “per 100 mL” in order to meet certain international requirements?**

*Answer:* Yes. Section 21 CFR 101.9(b)(10) permits the voluntary listing of nutrition information per 100 grams or 100 mL of the food as packaged or purchased. A column may also be presented with nutrition information “per 1 oz” or “per 1 fl oz” as packaged or prepared.

**L81. Products such as mini egg rolls, pizza rolls, and stuffed pastry are categorized as mixed dishes. However, on the label of these products, they are promoted as appetizers, as well as side dishes. How can the products be labeled to show their use as appetizers with a smaller serving size than as a side dish?**

*Answer:* The regulations allow a second column of nutrition information to be declared for a food provided that it is not misleading to consumers. The serving size and first column of nutrition information for these products would be based on their use as a mixed dish, but the second column could be based on their use as an appetizer. 21 CFR 101.9(b)(11), 21 CFR 101.9(e)

**L82. Although sauerkraut and pickled beets are categorized under “pickles, all types” with a RACC of 30 grams, can they also be labeled as a vegetable side dish with a RACC of 130 grams?**

*Answer:* Yes, manufacturers may use a second column to declare information based on a different serving size. The first column under the Nutrition Facts label would show the serving size, servings per container, and nutrition information based on a 30 gram RACC for the pickled vegetable and the second column could show nutrition information based on the RACC for the product used as a vegetable side dish. 21 CFR 101.9(b)(11) and 21 CFR 101.9(e)

## Serving Size/Single Serving Containers

### L83. What are the exemptions for single-serving containers?

**Answer:** Single serving containers may omit the “servings per container” declaration. In addition, most single serving containers may omit the metric equivalent portion of the serving size declaration. However, if it is voluntarily included, it must be consistent with the net quantity of contents value. The serving size for single-serving containers must be a description of the container such as: “Serving Size: 1 package” for food in bags, “Serving Size: 1 container” for foods in plastic containers, or “Serving Size: 1 can” as appropriate. Only those few foods that are required to declare drained weights must include the metric equivalent as part of the serving size declaration (e.g., “Serving size: 1 can drained (\_\_\_g)”). *21 CFR 101.9(b)(5)(iv)*, *21 CFR 101.9(b)(7)(i)* and *21 CFR 101.9(d)(3)(ii)*

### L84. How do I know if my product is a single-serving container?

**Answer:** Single-serving containers are discussed in *21 CFR 101.9(b)(6)*. Products that are packaged and sold individually are considered to be single servings if they contain less than 200% of the RACC for the product category. Above 200% of the RACC, it is the manufacturer's option to label the product as a multi-serving container or as a single-serving container if it can reasonably be consumed at a single eating occasion. For example, the RACC for brownies is 40 g. All brownies that are packaged and sold individually and that weigh less than 80 g must be labeled as a single serving. If the manufacturer believes it is reasonable for an individually packaged brownie that weighs more than 80 g to be consumed at one time, such a brownie may also be labeled as one serving.

### L85. What about single-serving containers for products that have larger RACCs, such as soup?

**Answer:** If a product has a RACC of 100 g or 100 mL or larger and is packaged and sold individually, it must be labeled as a single-serving if it contains 150% or less of the RACC. However, packages for such products containing between 150% and 200% of the RACC may be labeled as one or two servings at the manufacturer's option.

For example, the RACC for potato salad is 140 g. Containers of potato salad that are packaged and sold individually and that weigh 210 g or less must be labeled as a single serving. Containers weighing between 210 g and 280 g may be labeled as 1 or 2 servings. However, the serving size for a product labeled as two servings is based on the household measure and not on the weight of 1/2 package. *21 CFR 101.9(b)(6)*

### L86. What are the differences between labeling for single-serving containers and multi-serving containers?

**Answer:** The serving size statement for multi-serving containers must use the hierarchy of common household measures (*21 CFR 101.9(b)(5)(i)-(iii)*), whereas single-serving containers are required to use a description of the individual container or package (*21 CFR 101.9(b)(5)(iv)*). Multi-serving packages must list the metric equivalent to the household measure and the number of servings in the container; however this is optional information on single-serving containers. If the metric equivalent is listed on single-serving containers, it must match the net contents declaration for the product.

Nutrition Facts	
Serving Size 1 can	
Amount Per Serving	
Calories 140	
	% Daily Value*
Total Fat 0g	0%
Sodium 20mg	1%
Total Carbohydrate 36g	12%
Sugars 36g	
Protein 0g	

\*Percent Daily Values are based on a 2,000

An example of a single-serving container would be a 360 mL can of soda that is packaged and sold individually. The serving size for this product would be “1 can” or “1 can (360 mL),” and the number of servings would be “1” or not listed at all. By contrast, the serving size for a one liter soda bottle (1000 mL) would be “8 fl oz (240 mL) or “1 cup (240 mL),” and the number of servings would be listed as “about 4.”

**L87. Won't the serving sizes vary for products, such as soft drinks, that are packaged in different size single-serving containers and in larger bulk containers?**

*Answer:* Yes. The serving size for beverages in single-serving containers is the total contents of the container. Thus, the serving size would be listed as “1 bottle,” but the contents could vary greatly (e.g., 8 fl oz, 12 fl oz, 16 fl oz, etc.). Since the RACC for beverages is 240 mL, the serving size for multi-serving beverage containers such as the commonly available one-liter bottle would be either “1 cup (240 mL)” or “8 fl oz (240 mL).”

**L88. The RACC for muffins is 55 grams. If a single, large muffin weighs 130 grams, can it be labeled as one serving?**

*Answer:* A 130 gram muffin weighs 236% of the RACC for muffins. Products that weigh more than 200% of the RACC may be labeled as one serving if the entire contents of the package can reasonably be consumed at a single eating occasion. Therefore, there are two options for the serving size declaration for this large muffin: “1 muffin (130 g)” or “1/2 muffin (65 g).” 21 CFR 101.9(b)(6)

**L89. Are there limits on the size of a package that may be labeled as a “single serving”?**

*Answer:* Products that are packaged and sold individually are considered to be single servings if they contain less than 200% of the RACC shown in 21 CFR 101.12. For packages that contain 200% or more of the RACC, it is the manufacturer's option to label the product as a single serving if the entire contents can reasonably be eaten at one time. 21 CFR 101.9(b)(6)

**L90. What is the smallest amount of food that may be labeled as two servings?**

*Answer:* The answer depends on the size of the RACC. For foods with RACC less than 100g (solid foods) or 100mL (liquids), packages must contain at least 200% of the RACC to be labeled as 2 servings. For foods with RACCs of 100g or 100mL or more, you may choose to label packages containing more than 150% but less than 200% of the RACC as either one or two servings. 21 CFR 101.9(b)(6) and 21 CFR 101.12(b)

## **Serving Size/Servings Per Container**

**L91. Can the number of servings be listed as “1.5” or “about 1.5”?**

*Answer:* No. Rounding to the nearest 0.5 servings is allowed between 2 and 5 servings. Below 2 servings, the number of servings must be listed as “1” or “about 2.” For example, the RACC for egg rolls is 140 g. Since the RACC is greater than 100 g, a package of egg rolls containing more than 150% but less than 200% of the RACC can be labeled as 1 or 2 servings. For example, a



package of egg rolls weighs 225 g and contains 3 egg rolls (75 g each). The manufacturer may choose to label the product as 1 serving (3 egg rolls (225 g)). Alternatively, if the manufacturer chooses to label the product as more than 1 serving, the serving size would be “2 egg rolls (150 g).” The number of servings, determined as the total contents divided by the serving size, would be 1.5 and would be rounded to “about 2.” 21 CFR 101.9(b)(8)

## Serving Size/Small Discrete Units

### L92. What are the key considerations when determining a serving size for a product that consists of small discrete units?

**Answer:** Serving sizes for products in discrete units (e.g., muffins, sliced bread, and individually-packaged products in multi-serving packages) are discussed in 21 CFR 101.9(b)(2)(i). The serving size options depend on the RACC for the product and the weight of a single discrete unit.

- -If a single unit weighs 50% or less of the RACC, the serving size will be the number of whole units closest to the RACC. For example, the RACC for hard candy is 15 g; therefore, 50% of the RACC is 7.5 g. For a bag of candy where the individual candies weigh 4 g (less than 7.5 g), the serving size would be “4 candies (16 g).”
- -If a single unit weighs more than 50% but less than 67% of the RACC, there are two options for declaring serving size, either 1 or 2 units. For example, the RACC for snack crackers is 30 g; thus 50% of the RACC is 15 g, and 67% of the RACC is 20.1 g. For a box of crackers where the individual crackers weigh 17 g, (15 g < 17 g < 20.1 g), the serving size would be either “1 cracker (17 g)” or “2 crackers (34 g).”
- -If a single unit weighs 67% or more but less than 200% of the RACC, then the serving size must be declared as 1 unit. For example, the RACC for bread is 50 g; therefore 67% of the RACC is 33.5 g, and 200% of the RACC is 100 g. One slice of bread would be used as the serving size for breads: “1 slice (45 g).” However, if the RACC is 100 g, or 100 mL for liquids, or larger, and the product weighs more than 150% but less than 200% of the RACC, the manufacturer may decide whether the individual unit is 1 or 2 servings (also, see questions for single-serving containers).
- -If the single unit weighs 200% or more of the RACC, there are two options. The serving size can either be declared as one unit if the entire unit can reasonably be eaten on one occasion or can be declared as a portion of the unit. For example, the RACC for candy bars is 40 g, and 200% of the RACC is 80 g. For a 90 g candy bar, the serving size could be either “1 candy bar (90 g)” or “½ candy bar (45 g).”

FDA also provides additional specific provisions for (1) products (such as pickles) that naturally vary in size 21 CFR 101.9(b)(8)(ii); (2) products made up of two or more foods, packaged and intended to be consumed together 21 CFR 101.9(b)(5)(vii); and (3) products containing several, fully labeled, single serving units. 21 CFR 101.9(b)(5)(iv)



**L93. The RACC for beverages is 240 mL (8 fl oz). If a product is packaged as a group of 6 fl oz bottles (discrete units), should the serving size for this product be declared as “8 fl oz (240 mL)”?**

*Answer:* For products with RACCs of 100 mL or larger, the serving size for discrete units that contain 67% or more but less than or equal to 150% of the RACC is 1 unit. For beverages, this range is 160.8 mL to 360 mL. Thus, “1 bottle” would be the serving size for beverages packaged in 6 fl oz (180 mL) bottles.

**L94. The RACC for “cakes, heavy weight” is 125 grams. If the individual portions of a pre-sliced cake weigh 55 grams, what would be the serving size declaration?**

*Answer:* The pre-portioned slices are treated like all other discrete units. The 55 g piece of cake is less than 50% of the RACC for heavy weight cakes (50% of 125 g = 62.5 g); therefore the serving size will be the number of units closest to the RACC. Two pieces weigh 110 g, and 3 pieces weigh 165 g; therefore, the serving size would be “2 pieces (110 g)”. 21 CFR 101.9(b)(2)(i)(A)

## **Serving Size/Large Discrete Units**

**L95. What are the steps for determining a serving size for a product that is a large discrete unit?**

*Answer:* Serving sizes for products in large discrete units usually divided for consumption (e.g., cake, pie, pizza, melon, cabbage) are discussed in 21 CFR 101.9(b)(2)(ii). The serving size depends on the RACC for the product and on the fraction of the large discrete unit. The serving size is expressed using the allowed fraction (“friendly fraction”) that is closest to the RACC.

For example, the RACC for pizza is 140 g. A 16 oz (454 g) pizza can be divided in half (one piece = 227 g), thirds (one piece = 151 g), fourths (one piece = 113 g), etc. The closest fraction is 1/3; therefore the serving size would be “1/3 pizza (151 g).” Allowable fractions include 1/2, 1/3, 1/4, 1/5, 1/6, or smaller fractions that can be generated by further division by 2 or 3. An additional example would be: 1/8 (i.e., 1/4 divided by 2). Thus, fractions such as 1/7, 1/11, 1/13, and 1/14 are not allowed.

## **Serving Size/Bulk Products**

**L96. I have several products that are bulk products and I want to know the appropriate serving size to list on the label. How do I start, and what steps should I follow?**

*Answer:* Serving sizes for non-discrete bulk products (e.g., breakfast cereal, flour, sugar, dry mixes, concentrates, pancake mixes, macaroni and cheese kits) are discussed in 21 CFR 101.9(b)(2)(iii). The serving size depends on the RACC for the product and on the household measure. The serving size is expressed using the allowed household measure that is closest to the RACC.

For example, the RACC for snacks is 30 g. If a bag contains a mixture of nuts and caramel popcorn that weighs 23 g per cup, then 1 1/4 cup weighs 28.75 g and 1 1/3 cup weighs 30.7 g. The closest household measure is 1 1/3 cup; therefore the serving size would be “1 1/3 cup (31 g).”

Allowable household measures include (a) cups as 1/4, 1/3, 1/2, 2/3, 3/4, 1,

1 1/4, 1 1/3, etc, (b) tablespoons as 1, 1 1/3, 1 1/2, 1 2/3, 2, and 3, and (c) teaspoons as 1/8, 1/4, 1/2, 3/4, 1, and 2. In addition, piece, slice, tray, jar, fraction, and ounce may be used in accordance with the provisions of 21 CFR 101.9(b)(5).

**L97. What if the dehydrated mixed dish product contains several inner packages of ingredients intended to be mixed together to prepare a bulk product, such as macaroni and cheese?**

**Answer:** In these cases, manufacturers may use an ounce declaration (21 CFR 101.9(b)(5)(vii)). For example, the RACC for prepared macaroni and cheese is 1 cup. If a 12 oz package (9 oz dry macaroni and 3 oz dry cheese mix) makes 3 cups of prepared macaroni and cheese, then the serving size for the composite product could be expressed as “4 oz (112 g/about 2/3 cup macaroni and 2 tbsp dry cheese mix).” Alternatively, the manufacturer may provide nutrition information separately for each component. Thus, the serving size could also be expressed as “3 oz dry macaroni (84 g/about 2/3 cup)” and “1 oz dry cheese mix (28 g/about 2 tbsp).”

**L98. What is the serving size for products such as a cake mix?**

**Answer:** For products that require further preparation, where the entire contents of the package are used to prepare a large discrete unit usually divided for consumption, the serving size is the amount of the unprepared product used to make one “RACC for the prepared product.” The “RACC for the unprepared product” is the amount of the unprepared product that is required to make the fraction of the prepared product closest to the RACC of the prepared product. For example, a prepared medium-weight cake has a RACC of 80 grams. If 480 grams of cake mix makes 900 grams of prepared cake, then 1/12 of the prepared cake (75 g) is the closest fraction to the 80 gram RACC for medium weight cakes. Therefore, the RACC for the unprepared cake is 1/12 of 480 g, or 40 g. The serving size could be listed as “1/12 package (40 g/about 1/3 cup mix).”

## **Serving Sizes/Common Household Measures**

**L99. How do I choose appropriate household measures for declaring the serving sizes for products?**

**Answer:** Common household measures are discussed in 21 CFR 101.9(b)(5). Manufacturers must first try to express serving sizes for their products using cups, tablespoons, or teaspoons (21 CFR 101.9(b)(5)(i)). Second, if cups, tablespoons, and teaspoons are not appropriate, then whole units and fractions of large whole units must be used (if appropriate), such as pieces, slices, tray, or jar (21 CFR 101.9(b)(5)(ii)). Finally, if other options fail (usually because the product size naturally varies to a considerable degree), manufacturers must use ounces with an appropriate visual unit of measure (21 CFR 101.9(b)(5)(iii)).

For example, small pastas, such as macaroni, can be measured by cup: “\_\_ cup (\_\_ g).” Larger discrete pastas, such as lasagna, can be measured by the piece: “\_\_ lasagna noodles (\_\_ g).” A few pastas, such as spaghetti, may need to use ounces: “\_\_ oz (\_\_ g/visual unit of measure).” Visual units of measure could include descriptive phrases such as “1/8 box” or “about 1 1/4-inch circle of spaghetti.”

## Exemptions/Special Labeling Provisions

---

### General

**L100. If a manufacturer chooses to nutrition label voluntarily a food that is otherwise exempt, must the manufacturer follow the labeling regulations?**

*Answer:* Yes, if a manufacturer, packer, distributor or retailer chooses to nutrition label a product that is exempt under 21 CFR 101.9(j), all applicable labeling regulations must be followed.

**L101. If a nutrient content claim is made for only one size package, are packages that do not include the claim, and that are otherwise exempt, required to also bear nutrition labeling?**

*Answer:* No, only the package that bears the claim is required to provide nutrition labeling.

**L102. If a product is produced and sold in the same state (i.e., not shipped in interstate commerce), is it exempt from these regulations?**

*Answer:* Generally speaking, a food that involves no interstate commerce (i.e., it is not manufactured from ingredients that have moved in interstate commerce or itself is not distributed in interstate commerce) would not be subject to FDA regulation. However, FDA notes that interstate commerce is interpreted very broadly and, additionally, many states model their requirements after FDA's.

**L103. Is nutrition labeling required for imported products?**

*Answer:* All imported products are required to have nutrition labeling unless the product qualifies for an exemption. 21 CFR 101.9(j)

**L104. Would foods that are exempt from nutrition labeling under 21 CFR 101.9(j) also be exempt from other labeling requirements?**

*Answer:* The exemptions in 21 CFR 101.9(j) apply only to nutrition labeling requirements when the food bears no claim or other nutrition information.

### Small Business

---

**L105. If a retail establishment produces \$51,000 worth of food, but had a total gross sales for all products, food and non-food, of \$490,000, do they need a nutrition label?**

*Answer:* No. The firm is exempt provided that no claims are made. A firm whose total gross sales for all products, food and non-food, is \$501,000, with only \$49,000 of this figure representing sales of food, is also exempt. Under the NLEA, firms who have an annual gross sales made or business done in sales to consumers that is not more than \$500,000 or have annual gross sales made or business done in sales of food to consumers of not more than \$50,000 are exempt under 21 CFR 101.9(j)(1)(i).

The following chart illustrates the exemption:

<i>Sales in Food to Consumers</i>	<i>Total Sales (Food &amp; Non-Food)</i>	<i>Status</i>
\$50,000 or less	\$500,000 or less	Exempt
\$50,000 or less	\$500,001 or more	Exempt
\$50,001 or more	\$500,000 or less	Exempt
\$50,001 or more	\$500,001 or more	Not Exempt

**L106. Company “X” is a multimillion dollar firm that produces only private label products for other companies using the other companies trade name and logo. Are products produced by company “X” required to bear nutrition labeling?**

*Answer:* Products manufactured for a company that is not exempt must bear nutrition labeling. The company whose name appears on the label is responsible for providing nutrition information. Company “X” is not required by law to provide the nutrition information to the private labeler. However, company “X” may wish to develop nutrition information for their product line and provide it to their customers for use on the label.

**L107. What type of records need to be kept to substantiate a small business exemption, and will FDA be maintaining copies of any records for this exemption?**

*Answer:* It is up to each company to maintain records, such as tax returns, to support such an exemption. FDA will not maintain such records.

**L108. When determining whether or not there is a small business exemption, is it required that “brokered sales” of foods be included in determining gross sales for the business?**

*Answer:* The agency defines “brokered sales” as the sale of foods shipped in bulk form that are not for distribution to consumers but are for use solely in the manufacture of other foods or that are to be processed, labeled, or repackaged at a site other than where originally processed or packed. Accordingly, any brokered sale would not need to be considered in determining eligibility for the small business exemption.

**L109. A manufacturer who qualifies for a small business exemption sells his product to a large retailer who then repacks it in the deli and places it on self-service shelves. Is the product exempt from nutrition labeling if the retailer puts the small manufacturer’s name on the product?**

*Answer:* Yes. As long as the retailer is simply repacking the food into smaller containers and placing the small business’s name and address on the packaged food (i.e., the package label bears no name or logo that would tie the product to the larger retailer), the food would retain any exemption it was eligible for under *21 CFR 101.9(j)(1) or (18)*.

**L110. A small retailer purchases a bulk product from a large manufacturer and repacks the product for retail sale using the retailer’s name and logo. Is the product exempt from nutrition labeling?**

*Answer:* If the retailer is eligible for the exemption in *21 CFR 101.9(j)(1)* (based on gross sales), product purchased from a large manufacturer but repacked by the retailer would be exempt from nutrition labeling, as long as the package label bears no name or logo that would tie the product to the manufacturer. However, to be eligible for the exemption in *21 CFR 101.9(j)(18)*, the product must meet the definition of low volume products (based on the total number of units of the product sold by the large manufacturer in the United States).

**L111. What are the requirements for the exemption from nutrition labeling for a low volume food product?**

*Answer:* The exemption for low volume food products is based on the average number of full time equivalent employees (FTE's) and the number of units of product sold in the United States.

**L112. Do all firms need to file with FDA for a small business exemption?**

*Answer:* No. Firms eligible for the exemption based on gross sales and firms with less than 10 FTE's and less than 10,000 units do not have to file with the FDA. However, such firms can choose to do so voluntarily in order to establish a record that they are claiming an exemption. Also, all importers must file. *FD&C Act 403(q)(5)(E)(iii), 21 U.S.C. 343(q)(5)(E)(iii) and 21 CFR 101.9(j)(1) & (j)(18)*

**L113. Do the small business exemptions apply to restaurants?**

*Answer:* There is a separate exemption from nutrition labeling for foods sold in restaurants of any size, provided the food does not bear a claim (*21 CFR 101.9(j)(2)*). These foods do not need the small business exemptions. However, to the extent that a restaurant distributes food products for sale outside the restaurant (e.g., through grocery stores), such products may be eligible for an exemption from nutrition labeling under the small business exemptions.

## **Away-From-Home Foods**

**L114. Is a manufacturer that produces institutional and restaurant foods required to provide nutrition information?**

*Answer:* Foods which are served or sold for use only in restaurants and other establishments in which food is served for immediate consumption are exempt from nutrition labeling. However, if there is a reasonable possibility that the product will be purchased directly by consumers (e.g., club stores), nutrition information is required. *21 CFR 101.9(j)(2)(iii) and 21 CFR 101.9(j)(2)(v)(B)*

**L115. Must nutrition information be presented on individual packets intended for use in restaurants and institutions (e.g., catsup, mayonnaise, soy sauce) if claims are made?**

*Answer:* Individual serving size packages that are served to consumers and make a claim are required to have nutrition labeling (e.g., light salad dressing).

**L116. Would it be useful for labels of products that are exempt to carry a disclaimer such as “not intended for retail sale” or “for further processing”?**

*Answer:* It is up to the manufacturer to determine its own exemption status, and such a statement can not be used to avoid compliance with the regulations.

**L117. Would food served or sold in carry-out boxes, doggie bags, or sanitary wrappers be considered “packaged food?”**

*Answer:* Food sold in a restaurant or other retail establishment (e.g., a bakery or delicatessen) that is sold from behind a counter and placed in a wrapper, carry-out box, or other non-durable container whose sole purpose is to facilitate handling would not be considered “packaged food” and would not

need to bear a net weight statement, ingredient declaration, or the other labeling required of packaged foods. However, if consumers make their selections based on the food in its packaged form (e.g., the food is wrapped or boxed by the retailer and sold from a self-service case in a corner of a restaurant, or across the aisle from an in-store deli), the food must bear all required information.

**L118. Could FDA provide additional guidance on what foods sold in delis and bakeries are exempt?**

*Answer:* This exemption is based on 3 primary criteria: 1) when the food is consumed, 2) the location in which the food is processed and prepared, and 3) the extent to which the food is processed and prepared (i.e., must be ready-to-eat and of the type served in restaurants).

Bakeries and delis that sell foods for immediate consumption (e.g., where the deli or bakery has facilities for customers to sit and consume the food on the premises) are considered analogous to restaurants and all foods sold in such establishments are exempt under *21 CFR 101.9(j)(2)* provided no claims are made.

When foods are not for immediate consumption, they may be exempt if they meet all of the criteria listed in *21 CFR 101.9(j)(3)*. That is, when the food is ready-to-eat and is processed and prepared primarily on the premises of the establishment from which it is sold, it is exempt - regardless of how it is sold (i.e., from behind a counter or in pre-portioned packages from a self-service shelf). However, if the food is not primarily processed and prepared on-site, nutrition labeling is required.

To meet the criteria for being “primarily processed and prepared on-site”, the food must be augmented on site in a manner that changes the nutrient profile of the food (i.e., filling, icing, enrobing). Washing and garnishing with nuts, onions or seeds would fall under the definition of “primarily processed and prepared” if the added foods change the nutrition profile of the finished product. Custom cakes are exempt.

If pre-formed dough, pre scaled/molded and par baked dough are merely proofed and baked or simply thawed, the product is considered to be “standardized” and nutrition labeling is required.

Foods which are not prepared on premises and that are portioned to consumer specifications on-site are not required to have nutrition labeling (e.g., 1 lb of potato salad; 2 lb cheese, 1 lb assorted cookies, 5 rolls). However, if these items are packaged and offered for sale in another section of the store (e.g., refrigerator case; self service bins), nutrition labeling is mandatory. *21 CFR 101.9(j)(3)(iv)*

**L119. I manufacture candy for sale on premises and at my two satellite stores. The total dollar volume of my firm is over \$500,000. Am I required to nutrition label my products?**

*Answer:* Candy sold at the manufacturing site is not required to have nutrition labeling. Also, individual candies offered from behind a counter for consumer selection (i.e., packaged to consumer specification) are not required to have nutrition labeling. However, consumer packages of candy offered for sale at the satellite stores must have nutrition labeling. The same applies to bakeries that sell product at satellite stores.



**FRUIT DESSERT FOR CHILDREN  
LESS THAN 2 YEARS OLD**

<b>Nutrition Facts</b>	
Serving Size 1 jar (140g)	
<b>Amount Per Serving</b>	
<b>Calories</b> 110	
<b>Amount Per Serving</b>	
<b>Total Fat</b>	0g
<i>Trans</i> Fat	0g
<b>Sodium</b>	10mg
<b>Total Carbohydrate</b>	27g
Dietary Fiber	4g
Sugars	0g
<b>Protein</b>	5g
<b>% Daily Value</b>	
Protein 0%	• Vitamin A 6%
Vitamin C 45%	• Calcium 2%
Iron 2%	

21 CFR 101.9(j)(5)(i)

**FRUIT DESSERT FOR CHILDREN  
AGES 2 YEARS TO 4 YEARS**

<b>Nutrition Facts</b>	
Serving Size 1 jar (140g)	
<b>Amount Per Serving</b>	
<b>Calories</b> 110	Calories from Fat 0
<b>Amount Per Serving</b>	
<b>Total Fat</b>	0g
Saturated Fat	0g
<i>Trans</i> Fat	0g
<b>Cholesterol</b>	0mg
<b>Sodium</b>	10mg
<b>Total Carbohydrate</b>	27g
Dietary Fiber	4g
Sugars	0g
<b>Protein</b>	0g
<b>% Daily Value</b>	
Protein 0%	• Vitamin A 6%
Vitamin C 45%	• Calcium 2%
Iron 2%	

21 CFR 101.9(j)(5)(ii)

## **Foods of No Nutritional Significance**

### **L120. Are spices, coffee, and tea required to be nutrition labeled?**

*Answer:* The regulations provide for an exemption for foods that contain insignificant amounts, as defined in 21 CFR 101.9(j)(4), of all of the nutrients and food components required to be included in the nutrition label. Exempted foods include coffee beans (whole or ground), tea leaves, plain instant unsweetened instant coffee and tea, condiment-type dehydrated vegetables, flavor extracts, and food colors. Some spices contain levels of nutrients that would not meet the criteria of “insignificant” and would require nutrition labeling.

### **L121. Must aerosol oil sprays have nutrition labeling? The serving size is so small and all nutrient values are zero.**

*Answer:* A product would be exempt from nutrition labeling if it contains insignificant amounts of all the nutrients required to be on the label, so long as no nutrient content or health claims are made for the product.

### **L122. When labeling mineral water, is nutrition labeling required if the label does not reference any specific minerals?**

*Answer:* Under FDA labeling regulations the term Mineral Water is a statement of identity and does not trigger mandatory nutrition labeling if there is no nutrient content claims about a particular mineral and if all required nutrients are present at insignificant levels.

### **L123. Does FDA require nutrition labeling if minerals are declared on bottled water to meet state regulations?**

*Answer:* If a nutrient for which there is an RDI or DRV is referenced on the label, nutrition information is required. However, if state regulations require declaration of nutrients which are not provided for on the nutrition label (e.g., fluoride, arsenic), nutrition labeling cannot accommodate such nutrients and nutrition labeling is therefore not required.

## **Labels for Infants and Small Children**

### **L124. What are the special aspects of the Nutrition Facts labels for products intended for infants and small children?**

*Answer:* Nutrition Facts labels for foods specifically for children less than 4 years do not provide % Daily Values for the macronutrients or footnote required in 21 CFR 101.9(d)(9). Also, foods specifically for children less than 2 years of age must not present information on calories from fat and calories from saturated fat and quantitative amounts for saturated fat, polyunsaturated fat, monounsaturated fat and cholesterol. In both cases, % Daily Value is declared only for protein, vitamins, and minerals.



## Small Packages and Intermediate-Sized Packages

### L125. What are the special labeling provisions for small and intermediate-sized packages?

**Answer:** Food packages with a surface area of 40 sq. in. or less available for labeling may place the Nutrition Facts label on any label panel (not limited to the information panel), may omit the footnote required in 21 CFR 101.9(d)(9) if an asterisk is placed at the bottom of the label with the statement “Percent Daily Values are based on a 2,000 calorie diet,” and, may also use the tabular display label format.

<b>Nutrition Facts</b>	<u>Amount Per Serving</u>	<u>% DV*</u>	<u>Amount Per Serving</u>	<u>% DV*</u>
	Serv. Size 1/3 cup (56g) Servings about 3 <b>Calories</b> 90 Fat Calories 20 * Percent Daily Values (DV) are based on a 2,000 calorie diet.	<b>Total Fat</b> 2g	<b>3%</b>	<b>Total Carb.</b> 0g
Sat. Fat 1g		<b>5%</b>	Fiber 0g	<b>0%</b>
<i>Trans</i> Fat 0.5g			Sugars 0g	
<b>Cholesterol</b> 10mg		<b>3%</b>	<b>Protein</b> 17g	
<b>Sodium</b> 200mg		<b>8%</b>		
Vitamin A 0%		•	Vitamin C 0%	•
			Calcium 0%	•
			Iron 6%	

21 CFR 101.9(j)(13)(ii)(A)(1)

### L126. Is there another special labeling provision if the tabular display label does not fit on small and intermediate-sized packages?

**Answer:** A linear (string) format may be used on food packages with 40 sq. in. or less total surface area available for labeling if the package shape or size cannot accommodate the nutrition information placed in columns on any label panel.

**Nutrition Facts** Serv. Size: 1 package, Amount Per Serving:  
**Calories** 45, Fat Cal. 10, **Total Fat** 1g (2% DV), Sat. Fat 0.5g (3% DV), *Trans* Fat 0.5g,  
**Cholest.** 0mg (0% DV), **Sodium** 50mg (2% DV), **Total Carb.** 8g (3% DV), Fiber 1g  
 (4% DV), Sugars 4g, **Protein** 1g, Vitamin A (8% DV), Vitamin C (8% DV), Calcium  
 (0% DV), Iron (2% DV). Percent Daily Values (DV) are based on a 2,000 calorie diet.

21 CFR 101.9(j)(13)(ii)(A)(2)

**L127. Are abbreviations permitted in Nutrition Facts labels for small and intermediate-sized packages?**

*Answer:* Food packages with a surface area of 40 sq. in. or less available for labeling may use the following abbreviations in the Nutrition Facts label:

<i>Label Term</i>	<i>Abbreviation</i>	<i>Label Term</i>	<i>Abbreviation</i>
Serving size	Serv size	Cholesterol	Cholest
Servings per container	Servings	Total carbohydrate	Total carb
Calories from fat	Fat cal	Dietary fiber	Fiber
Calories from saturated fat	Sat fat cal	Soluble fiber	Sol fiber
Saturated fat	Sat fat	Insoluble fiber	Insol fiber
Monounsaturated fat	Monounsat fat	Sugar alcohol	Sugar alc
Polyunsaturated fat	Polyunsat fat	Other carbohydrate	Other carb

21 CFR 101.9(j)(13)(ii)(B)

**L128. What is the exemption for small food packages?**

*Answer:* Small packages (less than 12 sq. in. total surface area available to bear labeling) may be printed with a telephone number or an address to obtain nutrition information. This exemption (using a telephone number or address in place of the Nutrition Facts label) is permitted only if there are no nutrient content claims or other nutrition information on the product label or in labeling and advertising. 21 CFR 101.9(j)(13)(i)



**L129. What is the minimum type size for the Nutrition Facts label on small packages?**

*Answer:* Small packages (less than 12 sq. in. total surface area available to bear labeling) may use type sizes no smaller than 6 point or all uppercase type of not less than 1/16 inch for all required nutrition information. 21 CFR 101.9(j)(13)(i)(B)

**L130. Is it acceptable to “downsize” the graphic elements of the Nutrition Facts label because of space constraints on a label?**

*Answer:* If space is limited on the label, there is flexibility to adjust non-required graphic elements to help fit the nutrition label to the available space. The required graphic elements are those that are specified in 21 CFR 101.9(d).

**L131. How is “total space available to bear labeling” calculated?**

*Answer:* In determining the total surface area available to bear labeling, flanges and ends (tops and bottoms) of cans, shoulders and necks and caps of bottles and jars, and folded flaps and other unusable area may be excluded; as provided for in 21 CFR 101.1(c) and 21 CFR 101.2(a)(1). However, packages that provide label information on tops, bottoms, or necks should include those areas when calculating available label space. The available label space includes the principal display panel and is not limited to currently labeled areas.

**L132. When should the bottoms of packages be included in calculating space available to bear labeling?**

*Answer:* When normal handling by the consumer would result in the bottom of the box being easily seen, such as frozen food boxes. The bottom of boxes stored end up would not be considered “available to bear labeling” since consumers do not look at these areas during normal handling. Likewise, the bottoms of cans and jars are not normally seen and would not be calculated when determining “space available to bear labeling.”

**L133. Is the criteria for exemption of “less than 12 square inches” applied to the total labeling area or only to the principal display and information panels?**

*Answer:* Section 101.9(j)(13)(i) states clearly that the area available for labeling is based on the total surface area available to bear a label.

**L134. Can we use the linear display on a small package that does not have room for the tabular display because of the space required by the UPC code?**

*Answer:* No. When determining what format is required, space occupied by vignettes, design and other non-mandatory label information must be considered as available label space. 21 CFR 101.9(j)(17)

**L135. How can nutrition labeling be put on novel packages such as a jar in the shape of an animal?**

*Answer:* If the package has less than 12 square inches of space available to bear labeling because of the irregular container surface and no claims are made, nutrition labeling requirements may be met by providing an address or phone number where consumers could obtain the information. 21 CFR 101.9(13)(i)

## **Bulk Containers**

---

**L136. How should nutrition labeling be accomplished for foods sold from bulk containers?**

*Answer:* Section 101.9(j)(16) allows foods sold from bulk containers to display the required nutrition information on the outside of the container or on posters, counter cards, tags, or similar measures. The containers these foods are put into when sold to the consumer do not need to bear nutrition labeling as long as the required nutrition information is displayed at point-of-purchase (i.e., plainly in view by the bulk containers).

**L137. When nutrition information is provided on the outside of bulk containers in grocery stores, must the information be presented in the format specified in 21 CFR 101.9(d)?**

*Answer:* Yes.

**L138. Is the inside of the lid an acceptable location for placing nutrition labeling on bulk containers?**

*Answer:* The regulations require that nutrition information be displayed to consumers on the labeling of the container plainly in view. Therefore, this method of labeling would be acceptable if the underside of the lid were displayed at all times and another means is used to protect the contents of the drum.

**L139. If a bulk food is repacked at the retail level and sold in packaged form instead of from the bulk container, do the individual packages have to carry nutrition labeling?**

*Answer:* Yes. When foods are received by a retail store in bulk form and repacked for sale to consumers as a packaged food, the package must meet all mandatory labeling requirements.

**L140. When placing nutrition labeling on bulk foods, how should the number of servings per bulk container be declared?**

*Answer:* The number of servings in a bulk container will vary according to the fill of the container, and such a number is of little or no usefulness to consumers. FDA would be unlikely to object to a statement that the “Servings per container” are “varied” on bulk food containers or on random weight portions of foods repackaged by the retailer.

**L141. Who is responsible for providing nutrition information for bulk foods?**

*Answer:* The retailer is responsible for displaying the nutrition information in the required format on or adjacent to the bulk container. The information may be obtained/provided by either the supplier or retailer. The decision as to who actually develops the information is up to those parties involved.

**L142. If a co-op sells bulk foods directly to consumers or consumer groups, must the bulk container bear nutrition labeling?**

*Answer:* Yes. Subject, of course, to the exemptions for small businesses.

## EXEMPTIONS

### Voluntary Nutrition Labeling of Raw Fruits, Vegetables and Fish

---

**L143. What are the 20 most frequently consumed raw fruits, vegetables, and fish? Are they determined on a regional basis?**

*Answer:* On July 25, 2006 (71 FR 42031), (corrected August 17, 2006 (71 FR 47439), FDA published a final rule to update the names and nutrition values of the top 20 raw fruits, vegetables, and fish. The 20 foods for each group are identified in 21 CFR 101.44. The same list is to be used nationwide. The 20 most frequently consumed raw fruits are: Apple, avocado (California), banana, cantaloupe, grapefruit, grapes, honeydew melon, kiwifruit, lemon, lime, nectarine, orange, peach, pear, pineapple, plums, strawberries, sweet cherries, tangerine, and watermelon. The 20 most frequently consumed raw vegetables are: Asparagus, bell pepper, broccoli, carrot, cauliflower, celery, cucumber, green (snap) beans, green cabbage, green onion, iceberg lettuce, leaf lettuce, mushrooms, onion, potato, radishes, summer squash, sweet corn, sweet potato, and tomato. The 20 most frequently consumed raw fish are: Blue crab, catfish, clams, cod, flounder/sole, haddock, halibut, lobster, ocean perch, orange roughy, oysters, pollock, rainbow trout, rockfish, salmon (Atlantic/coho/Chinook/sockeye, chum/pink), scallops, shrimp, swordfish, tilapia, and tuna.

**L144. Can retailers provide nutrition labeling for raw fruit, vegetables, and fish that are not among the top 20 items?**

*Answer:* Yes. The names and descriptions of these foods should clearly identify them as distinct from the foods among the most frequently

consumed list for which FDA has provided data (21 CFR 101.45(c)(1)). Nutrition labeling values for foods not on FDA's lists are subject to the compliance provisions of 21 CFR 101.9(g).

**L145. We package fresh tomatoes and want to put nutrition labeling on the package. Should we follow the guidelines for the voluntary program for raw fruit, vegetables, and fish (21 CFR 101.45) or the nutrition labeling format required by 21 CFR 101.9?**

*Answer:* When providing nutrition information on the package, even when nutrition labeling is otherwise voluntary, the information must be presented in a format that is consistent with the format requirements in 21 CFR 101.9(d).

**L146. How does FDA define “raw fruit and vegetables” for the voluntary nutrition labeling program? Are fresh herbs and nuts included under the voluntary nutrition labeling program if they are sold in the produce section of retail stores?**

*Answer:* The NLEA provides for voluntary nutrition labeling of “raw agricultural commodities and raw fish.” The FD&C Act defines “raw agricultural commodities” as any food in its raw or natural state, including all fruits that are washed, colored, or otherwise treated in their unpeeled natural form prior to marketing. Therefore, fruit and vegetables that receive little or no processing and no heat treatment, regardless of whether the fruit and vegetables are waxed, are subject to the voluntary program. In addition, for ease of administration the agency has chosen to draw a practical line in terms of retail selling practices and program implementation by including raw fruit and vegetables that are sold in the produce section and that are peeled, trimmed, cut and/or packaged with no added ingredients (e.g., carrot sticks, mixed salad greens) in the voluntary program when no claims are made for the product. When claims are made, nutrition labeling is required on the package unless the required nutrition information is provided on a poster or other means as specified in 21 CFR 101.45.

Accordingly, fresh herbs and nuts (e.g., walnuts, peanuts) that have no added ingredients, such as salt, and that are sold in the produce section would be exempt from nutrition labeling under the voluntary program. However, when shelled or unshelled nuts or produce are processed in a manner other than mixing with other raw produce items, peeling, trimming, or cutting, (e.g., dried fruit, roasted nuts, frozen melon balls), nutrition labeling is required under 21 CFR 101.9.

**L147. Is nutrition labeling still voluntary on packages of raw vegetables or fruits when processed foods, such as salad dressings and croutons, are added to the package?**

*Answer:* When processed foods, such as salad dressings or croutons, are added to packages of raw vegetables or fruits, the product is considered to be a multi-ingredient processed packaged food and is no longer part of the voluntary program.

Therefore, nutrition labeling is mandatory for the entire contents of the package. (Subject, of course, to the exemption for ready-to-eat food that is primarily processed or prepared at the retail location and the small business exemptions.)

**L148. Would the packaged salad with dressing be considered ready-to-eat if consumers have to open the package of dressing and add it to the salad greens themselves?**

*Answer:* Because restaurant salads may be served with the dressing on the side or the croutons in a side package, packages of salads prepared in the retail establishment would be considered ready-to-eat when the only preparation needed by the consumer is adding the dressing or croutons. In contrast, products that require a significant amount of assembly or preparation (e.g., a pizza kit) would generally not be considered ready-to-eat.

**L149. I understand that adding salad dressing to a package of greens makes the food a multi-ingredient processed food and nutrition labeling is required for the entire contents of the package. Does the requirement change if the packaged salad contains a packet of salad dressing that already bears nutrition labeling?**

*Answer:* No. Nutrition labeling is still required for both the greens and the salad dressing. However, 21 CFR 101.9(h)(1) allows separately packaged ingredients that are intended to be eaten at the same time to be labeled individually or with a composite value. Therefore, the greens and salad dressing can be labeled individually. If the nutrition label on the packet is visible at the point of purchase, the information on the dressing need not be reprinted on the outer bag.

**L150. Is nutrition labeling required for candied or caramel apples sold in the produce department?**

*Answer:* Yes. These products are multi-ingredient processed food products. Therefore, nutrition labeling is mandatory.

**L151. Is nutrition labeling required for raw, frozen fish that are packed or repacked by the retailer and sold in the frozen food section of the retail store?**

*Answer:* Raw single-ingredient fish that are packaged by the retailer, whether fresh or frozen, fall under the voluntary nutrition labeling program. However, for the retail store to be in compliance with the voluntary program, the nutrition labeling information must be available at point of purchase (i.e., be displayed in close proximity to the product) of both the fresh and frozen fish. It may be necessary for some retail stores to display signs/brochures with the nutrient data for fish in the frozen food section as well as the fresh fish section of the store. (21 CFR 101.45) In contrast, raw frozen fish that are packaged by a manufacturer (e.g., packaged in a box with a printed label and brand name) come under the mandatory nutrition labeling program.

**L152. Is nutrition labeling required for crab meat that is canned and pasteurized, but not shelf-stable?**

*Answer:* Pasteurized crab meat that is not shelf-stable and is sold on ice or refrigerated is included under the voluntary nutrition labeling program, whereas canned crab meat that is shelf-stable must bear nutrition labeling.

**L153. Are steamed shrimp exempt from nutrition labeling if they are purchased from a manufacturer and repacked in the retail store for sale from either the fresh fish or deli counters? Would it make a difference if the retailer adds a seasoning mix when steaming the shrimp or if a cocktail sauce is added to the package?**



**Answer:** Plain, thermally processed shelled or unshelled lobster, crab, and shrimp are included in the voluntary nutrition labeling program when sold in either the fresh fish or deli sections of the store. However, consistent with earlier answers for fruit and vegetable products, when a food is composed of more than one ingredient, some of which are not included in the voluntary program (such as a seasoning mix or cocktail sauce), it must bear nutrition labeling. These added ingredients would generally alter the nutrient content of the product so that the nutrient values posted for the voluntary program would no longer accurately represent the finished product. However, if the finished product meets the criteria for a ready-to-eat food, primarily processed and prepared at the location from which it is sold (e.g., steamed, spiced shrimp prepared in-house), it may be exempt from nutrition labeling under 21 CFR101.9(j)(3).

## 8. CLAIMS

### Nutrient Content Claims

#### **N1. What is a nutrient content claim (NCC)?**

*Answer:* It is a claim on a food product that directly or by implication characterizes the level of a nutrient in the food (e.g., "low fat," "high in oat bran," or "contains 100 calories"). 21 CFR 101.13(b), 21 CFR 101.13(a)

#### **N2. What nutrient levels must be present in a food to use NCCs on food labels?**

*Answer:* The nutrient levels needed to use NCCs are shown in Appendices A and B of this guidance.

#### **N3. If a NCC is not included in FDA's regulations can it be used on a label?**

*Answer:* No. Only those claims, or their synonyms, that are specifically defined in the regulations may be used. All other claims are prohibited. 21 CFR 101.13(b)

#### **N4. Where are NCCs specifically defined by the agency?**

*Answer:* In 21 CFR 101.13, Subpart D of part 101, and parts 105 and 107. 21 CFR 101.13(b)

#### **N5. Are there any requirements for NCCs regarding the size or style of type?**

*Answer:* Yes. A NCC may be no more than twice as prominent as the statement of identity (the name of the food). Specifically, the type size of the claim may be no more than two times the type size of the statement of identity. If the style of the type makes the claim unduly prominent compared to the statement of identity, it will be in violation of the regulations (even if the size of the type is appropriate). 21 CFR 101.13(f)

#### **N6. Is there any additional information that is required when a claim is made?**

*Answer:* Yes. A variety of information is required depending on the claim and what information is needed to prevent the claim from being misleading. Nutrition labeling is required for virtually all claims. 21 CFR 101.13(n)

#### **N7. What is a disclosure statement?**

*Answer:* It is a statement that calls the consumer's attention to one or more nutrients in the food that may increase the risk of a disease or health-related condition that is diet related. The disclosure statement is required when a nutrient content claim is made and when a nutrient in that food exceeds certain prescribed levels. The disclosure statement identifies that nutrient (e.g. "See nutrition information for sodium content"). 21 CFR 101.13(h)(1)

#### **N8. When is a disclosure statement required?**

*Answer:* It is a requirement when a NCC is made and the food contains one or more of the following nutrients in excess of the levels listed below per Reference Amount Customarily Consumed (RACC), per labeled serving, or, for foods with small serving sizes, per 50 grams.

(Different levels apply to main dish and meal products (see section 8 N18):

Total Fat	13.0 grams
Saturated Fat	4.0 grams
Cholesterol	60 milligrams
Sodium	480 milligrams

21 CFR 101.13(h)(1)

**N9. What is a food with a small serving size?**

*Answer:* It is a food with a RACC of 30 g or less or 2 tablespoons or less.

21 CFR 101.13(h)(1)

**N10. How must the disclosure statement be presented on the label?**

*Answer:* It must be in legible boldface type, in distinct contrast to other printed or graphic matter, and generally in a type size at least as large as the net quantity of contents declaration. It must also be placed immediately adjacent to the claim. 21 CFR 101.13(h)(4)(i)-(ii)

**N11. What is meant by "immediately adjacent to"?**

*Answer:* "Immediately adjacent to" means just that, right next to the claim. There may be no intervening material, such as vignettes or other art work or graphics. However, other required information such as the statement of identity (when the claim is part of the statement of identity such as "low fat cheddar cheese") and special disclosure statements (those required by section 403(r)(2)(A)(iii)-(v)), are permitted between the claim and the disclosure statement. 21 CFR 101.13(h)(4)(ii)

**N12. Could a statement of identity ever be considered intervening material?**

*Answer:* Yes, the claim and the statement of identity can be separate pieces of information on the label. If the statement of identity and the claim were printed in noticeably different type styles, sizes, colors or locations, for example, if the phrase "low fat" were in a star-burst, the claim and the statement of identity would be considered separate pieces of information. In such cases the disclosure statement would have to be adjacent to the claim, not separated from it by the statement of identity.

**N13. How is the type size for the disclosure statement determined?**

*Answer:* The type size for the disclosure statement is the same as that required for the net quantity of contents statement in 21 CFR 101.105(i); for example, for packages with a PDP of five square inches or less, the disclosure statement must be at least 1/16 inch in height; for packages with a PDP of 5-25 square inches, not less than 1/8 inch; for PDPs 25-100 square inches, not less than 3/16 inch; for packages with a PDP greater than 100 square inches, not less than 1/4 inch; and for packages 1/2 inch over 400 square inches. 21 CFR 101.13(h)(4)(i)

**N14. Are there any exceptions to the disclosure statement type size requirements?**

*Answer:* Yes. If a claim is less than two times the required size of the net quantity of contents statement, the disclosure statement may be half the size of the claim but not less than 1/16 inch. 21 CFR 101.13(h)(4)(i)

**N15. What are the disclosure statement type size requirements for extremely small packages?**

*Answer:* If a package has three square inches or less of available label space and is an individual serving-size package served with meals in restaurants, the disclosure statement may be no less than 1/32 inch in height. 21 CFR 101.13(h)(4)(i)

**N16. If several claims are made on one panel, is a disclosure statement required each time a claim is made?**

*Answer:* No. If multiple claims are made on a panel, only one disclosure statement per panel is required and it must be adjacent to the claim printed in the largest type on that panel. 21 CFR 101.13(h)(4)(iii)

**N17. If two claims are made on one panel, both in the same size print, where is the disclosure statement placed?**

*Answer:* The disclosure statement may be next to either claim.

**N18. When are disclosure statements required on meal-type products?**

*Answer:* A meal product (see 21 CFR 101.13(l) for definition of a "meal product") must be labeled with a disclosure statement if it contains (per labeled serving) more than:

- 26 g of fat, -
- 8 g of saturated fat, -
- 120 mg of cholesterol, or -
- 960 mg of sodium -

21 CFR 101.13(h)(2)

Likewise, a main dish product (see 21 CFR 101.13(m) for the definition of a "main dish product") must be labeled with a disclosure statement if it contains (per labeled serving) more than:

- 19.5 g of fat,
- 6.0 g of saturated fat, -
- 90 mg of cholesterol, or -
- 720 mg of sodium -

21 CFR 101.13(h)(3)

**N19. When may a "high" or a "good source" claim be made?**

*Answer:* A "good source" claim may be made when a food contains 10-19% of the RDI or DRV (both declared on the label as the % Daily Value (%DV)). A "high" claim may be made when a food contains at least 20% of the DV. 21 CFR 101.54(b)-(c)

**N20. May a "high" or a "good source" claim be made for a nutrient that does not have an established daily value?**

*Answer:* No. "High" and "good source" claims are defined as a percentage of the DV. Therefore, nutrients that do not have an established DV are not covered by the definition and may not make "high" or "good source" claims. 21 CFR 101.54(a)

**N21. Is there any way that a manufacturer can let consumers know that a product contains nutrients without DVs, such as omega-3 fatty acids?**

*Answer:* A manufacturer may make a statement about a nutrient for which there is no established daily value as long as the claim specifies only the amount of the nutrient per serving and does not implicitly characterize the

level of the nutrient in the product. Such a claim might be "x grams of omega-3 fatty acids." Such claims must be outside the Nutrition Facts label. *21 CFR 101.13(i)(3)*

**N22. May a label make statements using the words "contains" and "provides" (e.g., "Contains x grams of omega-3 fatty acids") for nutrients without DVs?**

*Answer:* To use the words "contains" or "provides" for nutrients without DVs, the specific amount of the nutrient *must* be stated. The statements "Contains x grams of omega-3 fatty acids per serving" or "Provides x g of omega-3 fatty acids" are permitted.

However, "Contains omega-3 fatty acids" or "Provides omega-3 fatty acids" (without the specific amount statement) would not be permitted. Such claims would be synonyms for a "good source" claim which is not permitted for nutrients that do not have established DVs. *21 CFR 101.54(c)*

**N23. Is a statement that describes the percentage of the RDI of a vitamin or mineral in a food outside the nutrition panel a NCC?**

*Answer:* Yes, while labels bearing these claims are exempt from certain labeling requirements, they are not exempt from bearing a disclosure statement when required and nutrition information. *21 CFR 101.13(q)(3)(i), 21 CFR 101.13(n), 21 CFR 101.13(h)*

**N24. May a food that is normally low in or free of a nutrient bear a "Low" or "Free" claim if it has an appropriate disclaimer (e.g., fat free broccoli)?**

*Answer:* No. Only foods that have been specially processed, altered, formulated, or reformulated so as to lower the amount of nutrient in the food, remove the nutrient from the food, or not include the nutrient in the food may bear such a claim (e.g., "low sodium potato chips"). Other foods may only make a statement that refers to all foods of that type (e.g., "corn oil, a sodium-free food" or "broccoli, a fat-free food"). *21 CFR 101.13(e)(1)-(2)*

**N25. When is a formulated food considered to be specially processed and permitted to bear a "low" or "free" claim?**

*Answer:* If a similar food would normally be expected to contain a nutrient, such as sodium in canned peas, and the labeled food is made in such a manner that it has little or none of the nutrient, then the food is considered specially processed and may bear a "free" or a "low" claim. *21 CFR 101.13(e)(1)*

**N26. If a product is made that does not have a regular version, such as a spice mix, and salt is not included in it, may the product be labeled "sodium free?"**

*Answer:* Yes. FDA would consider that the food was formulated so as not to include the nutrient in the food and therefore it would be eligible to bear a "sodium free" claim if the product otherwise meets the criteria for the term "sodium free."

**N27. May a "fat free" claim be made even though the product is essentially 100% fat, for example, a cooking oil spray that has a very small serving size?**

*Answer:* Although the food has less than 0.5 grams of fat per RACC and technically qualifies to make a "fat free" claim, such a claim on a product that

is essentially 100% fat would be misleading. Under section 403(a)(1) and 201(n) of the FD&C Act, the label would have to disclose that the product is 100% fat. However, the terms "fat free" and "100% fat" or "all fat" are contradictory and the statement seems confusing. FDA believes a claim such as "for fat free cooking" is more appropriate, so long as it was not made in a misleading manner and the words "fat free" were not highlighted, printed in a more prominent type, or otherwise set off from the rest of the statement.

**N28. What is meant by "product category" when the regulation say that for "less," "fewer" and "more" claims, the reference food may be a dissimilar food within a product category that can generally be substituted for one another in the diet. Are these product category the same as the 139 product categories used to describe the RACCs for serving sizes?**

*Answer:* These are not the same as the product categories established for serving sizes. The agency intentionally did not define "product category" in the final rule in order to allow for the use of a flexible standard. It intended that comparisons be made for foods that are interchangeable in the diet, recognizing that sometimes these foods would be dissimilar, for example "apples have less fat than potato chips").

**N29. When would such a claim as described in section 8 N28 (above) be considered misleading?**

*Answer:* A claim would be misleading if it compared two foods that are not reasonably likely to be used as alternative food choices for a specified eating occasion, for example, "apples have less fat than sour cream."

**N30. May a "Less" or "Fewer" claim be made that compares ready-to-eat cereals to other breakfast options such as sausages or Danish pastries?**

*Answer:* The agency would not object to such a claim if it were properly framed in the context of an eating occasion such as "Try a change for breakfast. A serving of this cereal has \_\_% less fat than a serving of Danish pastry". 21 CFR 101.13(j)(1)(i)(A)

**N31. Will I have to similarly frame, in the context of an eating occasion, comparisons between foods that are normally considered to be alternatives for one another such as pretzels for potato chips or one cookie for another cookie?**

*Answer:* No. Such substitutions would be generally understood by the consumer and would not have to be specified.

**N32. What is an appropriate reference food for a food bearing a "Light" claim?**

*Answer:* The reference food must be a food or group of foods that are representative of the same type as the food bearing the claim. For example, a chocolate ice cream would use as its reference food other chocolate ice creams. 21 CFR 101.13(j)(1)(i)(B)

The nutrient value for fat or calories in a reference food that is used as a basis for a "light" claim may be determined in several ways. It may be a value in a representative, valid data base; an average value determined from the top three national (or regional) brands of the food, a market basket norm; or where its nutrient value is representative of the food type, a market leader. 21 CFR 101.13(j)(1)(ii)(A)



The nutrient value used as a basis for a 'light' claim should be similar to that calculated by averaging the nutrient values of many of the foods of the type. It should not be the value of a single food or group of foods at the high end of the range of nutrient values for the food. When compared to an appropriate reference food, a "light" food should be a food that the consumer would generally recognize as a food that is improved in its nutrient value compared to other average products of its type. 21 CFR 101.13(j)(1)(ii)(A)

**N33. What is considered to be an "average nutrient value"?**

*Answer:* It might be a value in a data base that is appropriate for the food, or an average of nutrient levels in several of the leading brands of that type of food. It might also be a market basket norm. In determining an average nutrient value for a particular type of food, a manufacturer should take into account the nutrient variability of the product. 21 CFR 101.13(j)(1)(i)(A)

Some types of products are fairly uniform; others, such as chocolate chip cookies, are not. Obviously, in products in which there is wide variability among different versions of the same food type, more products should be considered in arriving at an accurate nutrient level.

**N34. How will anyone know what the reference food is and how it was derived?**

*Answer:* The type of food used as a reference food must be identified on the label as part of the accompanying information.

21 CFR 101.13(j)(2)(i)

In addition, the regulation requires that manufacturers using calculated nutrient values (averages, norms, etc.) as the basis for a claim be able to provide specific information on how the nutrient values were derived. This information must be available on request to consumers and to appropriate regulatory officials.

21 CFR 101.13(j)(1)(ii)(A)

**N35. How would a label state the identity of a reference food when the nutrient value used as a reference for the claim was from a data base or was an average of several foods?**

*Answer:* The label might state "50% less fat than regular Italian salad dressing" (on a light Italian dressing) or "half the fat of the average creamy Italian salad dressing" (on a light creamy Italian salad dressing). The label is not required to state that the reference value came from a data base. 21 CFR 101.13(j)(2)(i)

**N36. Can a reference food for a "light" product be an average of regional brands?**

*Answer:* Yes, so long as the regional brands are available in the same area in which the "light" product is sold.

**N37. Are there any circumstances in which the reference food for a "light" claim may be a single food?**

*Answer:* Yes. The agency has stated that if the nutrient levels in a food, such as the leading national or regional brand, were accurately reflective of the average of foods of that type, that food might be an appropriate reference food for a "light" product.

**N38. Is a market leader always an appropriate reference food?**

*Answer:* No. For example, if there are two market leaders with widely different nutrient profiles, selecting the one with the slightly higher market share for the reference food could be misleading. In that case the nutrient values for the two market leaders should be averaged together to determine a nutrient value for the basis of the “light” claim.

**N39. What if my product is a unique product and the only one of its kind on the market? Can I make a “light” version using the regular product as the reference food?**

*Answer:* Products that are truly unique may make the “light” comparisons to the regular version of the product.

**N40. What happens if the “light” version or other improved versions of the product become so popular that the regular version is no longer marketed?**

*Answer:* The agency believes that it would be misleading for comparisons to be made to products that are no longer marketed. Therefore, especially for products that are nontraditional or unique, the agency would find claims which are based on products that have been discontinued for more than 6 months to be misleading.

**N41. What if the product is not discontinued but has an extremely small market share? Would those products still be considered appropriate reference foods for “light” products?**

*Answer:* The agency would not consider any food to be an appropriate reference food for any relative claim if it did not have a significant market share. Just as it does not want foods to be specially created to be reference foods for relative claims, neither would it expect foods that can no longer be purchased by the consumer to be appropriate reference foods.

**N42. Is this always the case?**

*Answer:* There are conceivably some circumstances in which a traditional food (hypothetically, full-fat yogurt) might no longer be marketed and only the nutritionally improved food would be available. The agency would not generally consider comparisons of the nutritionally improved food to the traditional food to be misleading, as long as consumers are likely to have knowledge of the traditional food and the term “light” signals that the product was improved relative to the traditional food.

**N43. Is there any information that must be placed on the label when making relative claims such as “Light”?**

*Answer:* When making “light” claims, as with other relative claims such as “reduced,” “less,” “fewer,” “more,” or “added,” the label must state each of the following (these are called “accompanying information”):

- The percentage or fraction by which the food has been modified,
- The reference food, and
- The amount of nutrient (that is the subject of the claim) that is in the labeled food and in the reference food.

*Example:* 1/3 fewer calories and 50% less fat than our regular cheese cake. Lite cheese cake~200 calories, 4g fat; Regular cheese cake~300 calories, 8g fat per serving. 21 CFR 101.56(b)(3)(i)-(ii) and 21 CFR 101.13(j)(2)

**N44. Where must the accompanying information be placed?**

**Answer:** The percentage or fraction by which the food is modified and the identity of the reference food must be immediately adjacent to the most prominent claim on the label. *21 CFR 101.13(j)(2)(ii)* The actual amount of the nutrient in the labeled food and the reference food may be adjacent to the most prominent claim or on the same panel as the nutrition label. *21 CFR 101.13(j)(2)(iv)(B)*

**N45. What is the appropriate reference food for a NCC on a product that substitutes for a food and bears a name that is significantly different from that food?**

**Answer:** Examples are vegetable oil spreads that substitute for margarine or butter, and mayonnaise spreads that substitute for mayonnaise. To bear a claim, the labeled food, for example, vegetable oil spread, must be “not nutritionally inferior” to the food that it resembles and for which it substitutes (e.g., margarine). The reference food on which the claim is based should be the food that it resembles and for which it substitutes (e.g., margarine). Definition of “substitute food” is found in *21 CFR 101.13(d)*

**N46. What is the most prominent claim?**

**Answer:** In order, the most prominent claims are:

1. A claim on the PDP as a part of or adjacent - to the statement of identity; -
2. A claim elsewhere on the PDP;
3. A claim on the information panel;
4. A claim elsewhere on the label or in labeling.

*21 CFR 101.13(j)(2)(iii)*

**N47. How large must the accompanying information be?**

**Answer:** Generally the type size must be at least 1/16 of an inch in height. However, there are certain exemptions from this type size requirement for packaged foods that meet certain size requirements. Generally, the minimum type size is 1/32 inch for products with a total surface area available to bear labeling of less than 12 square inches. *21 CFR 101.2(c)*

**N48. Implied NCCs in brand names have to be authorized by the FDA. Does a petition have to be submitted before a claim may be used in any brand name?**

**Answer:** No. Implied claims that are specifically identified in *21 CFR 101.65* may be used in a brand name without submission of a petition under *21 CFR 101.69(o)*.

**N49. What are the requirements to use the word “Healthy”?**

**Answer:** You may use the term “healthy” or related terms as an implied nutrient content claim on the label or in labeling of a food that is useful in creating a diet that is consistent with dietary recommendations if the food meets the conditions for total fat, saturated fat, cholesterol, and other nutrients (See table in Appendix B of this guidance). In addition, the food must comply with definitions and declaration requirements for any specific NCCs. *21 CFR 101.65(d)(2)*

## **N50. What does “Fresh” mean?**

**Answer:** When used in a manner which suggests that a food is unprocessed, the term “fresh” means that the food is in a raw state and has not been frozen or subjected to any form of thermal processing or preservation, except:

- The addition of approved waxes or coatings;
- The post-harvest use of approved pesticides;
- The application of a mild chlorine wash or mild acid wash on produce;
- or**
- The treatment of raw foods with ionizing radiation not to exceed the maximum dose of 1 kiloGray in accordance with *21 CFR 179.26*, *21 CFR 101.95(a)* and *21 CFR 101.95(c)*

## **N51. What do the terms “Fresh Frozen” and “Quickly Frozen” mean?**

**Answer:** FDA’s regulation specifies that “fresh frozen” or “frozen fresh” means the food has been quickly frozen while still fresh (i.e., recently harvested when frozen). Appropriate blanching before freezing is permitted. “Quickly frozen” means freezing using a system such as blast-freezing (i.e., sub-zero Fahrenheit temperature with fast moving air directed at the food) for a sufficient length of time to freeze quickly to the center of the food with virtually no deterioration. *21 CFR 101.95(b)*

## **Health Claims**

### **H1. What is a Health Claim?**

**Answer:** Health claim means any claim made on the label or in labeling of a food, including a dietary supplement, that expressly or by implication, including “third party” references, written statements (e.g., a brand name including a term such as “heart”), symbols (e.g., a heart symbol), or vignettes, characterizes the relationship of any substance to a disease or health-related condition. Implied health claims include those statements, symbols, vignettes, or other forms of communication that suggest, within the context in which they are presented, that a relationship exists between the presence or level of a substance in the food and a disease or health-related condition (see *21 CFR 101.14(a)(1)*).

Further, health claims are limited to claims about disease risk reduction, and cannot be claims about the diagnosis, cure, mitigation, or treatment of disease. Health claims are required to be reviewed and evaluated by FDA prior to use. An example of an authorized health claim, is: “Three grams of soluble fiber from oatmeal daily in a diet low in saturated fat and cholesterol may reduce the risk of heart disease. This cereal has 2 grams per serving.”

### **H2. What health claims are permitted on food labels?**

**Answer:** If a claim is provided for in a FDA regulation, then it may be used in accordance with that regulation. A firm may also submit a health claim notification based on an authoritative statement by a U.S. government scientific body under section 403(r)(3)(c) of the FD&C Act. The criteria necessary to use health claims provided for by FDA are summarized in Appendix C of this guidance. *21 CFR 101.9(k)(1)*, *101.14(c)-(d)* & *21 CFR 101.70*

### H3. How are health claims different from structure/function claims?

**Answer:** Both health claims that meet the Significant Scientific Agreement (SSA) standard and Qualified Health Claims (QHCs) characterize the relationship between a substance to a disease or health-related condition (see *21 CFR 101.14*). Structure/function (S/F) claims describe the effect that a substance has on the structure or function of the body and do not make reference to a disease. Both S/F and health claims can be used on the label and in the labeling of conventional foods and dietary supplements. An example of a S/F claim is “Calcium builds strong bones.” S/F claims must be truthful and not misleading and are not pre-reviewed or authorized by FDA. *21 U.S.C. 343(r)(6) and 21 CFR 101.93*

### H4. How are health claims different from statements about dietary guidance?

**Answer:** Both health claims that meet the SSA standard and QHCs characterize a relationship between a substance and a disease or health-related condition (see *21 CFR 101.14*). Both elements of 1) a substance and 2) a disease are present in a health claim. Dietary guidance does not contain both elements (and therefore does not constitute a health claim, but may contain one element or another. Typically, dietary guidance statements make reference to a category of foods (i.e., a grouping that is not readily characterized compositionally) and not to a specific substance. The following illustrations may be helpful:

Two examples of an authorized health claim, which by definition must contain the elements of a substance and a disease or health-related condition, are: “Three grams of soluble fiber from oatmeal daily in a diet low in saturated fat and cholesterol may reduce the risk of heart disease. This cereal has 2 grams per serving.” and “Diets low in saturated fat and cholesterol that include 25 grams of soy protein a day may reduce the risk of heart disease”.

An example of dietary guidance, which does not refer to a specific substance but rather refers to a broad class of foods without an expressed or implied connection to a specific substance that is present the class of foods is: “Consuming at least 3 or more ounce-equivalents of whole grains per day can reduce the risk of several chronic diseases”. One element is present, but not both. It is not a health claim because it cannot reasonably be understood to be about a specific substance.

A dietary guidance statement that refers to a specific food or food component but not a disease or health-related condition is: “Carrots are good for your health,” or “Calcium is good for you.” Again, one element is present, but not both.

### H5. How is dietary guidance provided for on food labels?

**Answer:** Truthful, non-misleading dietary guidance statements may be used on food labels, and do not undergo pre-review by FDA. However, once the food is marketed with the statement, FDA can consider whether the statement meets the requirement to be truthful and not misleading. *Section 403(a) of the FD&C Act*

FDA, as part of its recent Better Nutrition Information for Consumer Health Initiative, recognized that scientifically sound and non-misleading dietary guidance statements may be useful to consumers when placed on food labels.

## **H6. What are the similarities and differences between health claims established under the 1993 regulations and QHCs?**

*Answer:* Both types of health claims characterize a relationship between a substance (specific food component or a specific food) and a disease (e.g., lung cancer or heart disease) or health-related condition (e.g., high blood pressure), and are supported by scientific evidence (see *21 CFR 101.14*). Health claims generally undergo review by FDA through a petition process. All health claims as provided for by Congress in 1990 were evaluated under the SSA standard. Past court decisions resulting in QHCs on dietary supplements focused on whether a manufacturer could make statements about diet/disease relationships when the science supporting the claim did not meet the SSA standard, provided that the claim about the relationship was stated or “qualified” in such a way as to not mislead consumers. Thus, QHCs differ from health claims in that they must be accompanied by a disclaimer or otherwise qualified. See the next section of this guidance for more information on QHCs.

## **Qualified Health Claims**

### **Q1. Why is FDA providing for “qualified” health claims (QHCs)?**

*Answer:* Through the Consumer Health Information for Better Nutrition Initiative, FDA acknowledged that consumers benefit from more information on food labels concerning diet and health. As part of this initiative, the agency established interim procedures whereby QHCs can be made not only for dietary supplements but for conventional foods as well. Moreover, past court decisions have clarified the need to provide for health claims based on less scientific evidence rather than just on the standard of Significant Scientific Agreement (SSA) as long as the claims do not mislead the consumers. FDA began considering QHCs under its interim procedures on September 1, 2003.

### **Q2. Why are the procedures for QHCs “interim”?**

*Answer:* FDA believes that more information is needed before the agency can establish final procedures to provide for QHCs, and therefore issued an Advanced Notice of Proposed Rulemaking (ANPRM) to solicit comments on the agency's options. FDA has and continues to conduct research in order to obtain information about appropriate qualifying language for use with the claims and the extent to which consumers can understand different levels of supporting science. The agency is also interested in knowing if there are better formats for presenting the supporting science than through the use of words alone.

### **Q3. What is a letter of enforcement discretion for QHCs?**

*Answer:* A letter of enforcement discretion is a letter issued by FDA to the petitioner specifying the nature of the QHC for which FDA intends to consider the exercise of its enforcement discretion. If a letter of enforcement discretion has been issued, FDA does not intend to object to the use of the claim as specified in the letter, provided that the products that bear the claim are consistent with the stated criteria. All letters of enforcement discretion are posted on the Center for Food Safety and Applied Nutrition's website so manufacturers know how the agency intends to exercise its enforcement discretion on the use of the QHC.



**Q4. How is the science supporting a QHC different from that for a health claim?**

*Answer:* Health claims require Significant Scientific Agreement (SSA) based on the totality of publicly available scientific evidence (see *21 CFR 101.14*). QHCs are still based on the totality of publicly available evidence but the scientific support does not have to be as strong as that for SSA. (See also H7)

**Q5. What is the procedural timeline for QHCs?**

*Answer:* Within 15 days of receipt, FDA will acknowledge the petition. Within 45 days of receipt, FDA will file the petition and a docket number will be assigned. Note: Petitions that do not meet content requirements as specified in *21 CFR 101.70* will not be filed and will be returned to the petitioner. At the time of filing, FDA will post the petition on the FDA webpage for a 60-day public comment period. During this time, written comments may be submitted to the docket. On or before 270 days after receipt of the petition, a final decision will be sent to the petitioner in the form of a letter as to whether FDA intends to exercise enforcement discretion with respect to a QHC or deny the petition. The letter will be posted on FDA's website. Extensions beyond 270 days can be granted upon mutual agreement between the petitioner and the agency.

**Q6. How will FDA know that I wish to have my petition reviewed under the standards for a QHC rather than those for an SSA health claim (i.e., under the SSA standard)?**

*Answer:* The petitioner may indicate within the petition's cover letter that he/she is waiving the right to a review under the SSA standard and request that the petition be reviewed under the interim procedures for a QHC. This request will result in FDA proceeding directly to the QHC procedures and its 270-day timeline (see next question). In the absence of such a request, FDA contacts the petitioner to determine if they are petitioning for a SSA or QHC.

**Q7. What information is required to be included in the petition?**

*Answer:* The requirements of *21 CFR 101.70* apply. A general summary of these requirements follows.

1. Preliminary Requirements (see *21 CFR 101.70(f)(A)*) Explanation of how substance conforms to the requirements of *21 CFR 101.14(b)*:
  - Relationship between substance and disease or health-related condition;
  - Substance contributes taste, aroma, nutritive value, or a technical effect listed in *21 CFR 170.3(o)*;
  - Substance is a food, food ingredient, or component that has been shown to be safe and lawful at levels necessary to justify a claim (*21 CFR 101.14(b)(3)(ii)*).
2. Summary of Scientific data (see *21 CFR 101.70(f)(B)*)
3. Analytical data to show amount of substance that is present in - representative foods (see *21 CFR 101.70(f)(C)*)
4. Proposed model health claim(s) (see *21 CFR 101.70(f)(D)*)
5. Attachments (see *21 CFR 101.70(f)(E)*)
  - Scientific data supporting a claim;
  - Copies of computer literature searches;
  - Copy of all research articles relied upon for support of petition ~ English only;

- Information concerning adverse consequences pertinent to any segment of the U.S. population.

6. A claim for categorical exclusion or an environmental assessment (see 21 CFR 101.70(f)(F))

NOTE: FDA encourages petitioners to specify whether they are requesting that their petition be reviewed as a QHC, and that they waive review under the SSA standard.

#### **Q8. Where should I send the petition?**

**Answer:** Mail the original and one copy of the petition (or a computer readable disk containing the petition) to the following address: -

Food and Drug Administration -

Office of Nutrition, Labeling and Dietary Supplements (HFS-800) -

5100 Paint Branch Parkway, College Park, MD 20740 -

#### **Q9. Are there circumstances when FDA will not file a petition?**

**Answer:** Yes, if the petition is incomplete in that it does not provide the required information that is summarized above.

#### **Q10. How can I find out what letters FDA has issued for QHC?**

**Answer:** See Qualified Health Claims: Letters of Enforcement Discretion at [www.fda.gov/Food/LabelingNutrition/LabelClaims/QualifiedHealthClaims](http://www.fda.gov/Food/LabelingNutrition/LabelClaims/QualifiedHealthClaims).

Alternately, you can go to Appendix D of this guidance for a listing of the QHCs available at the time this guidance was issued.

## **Structure/Function Claims**

### **S1. What are structure/function (S/F) claims?**

**Answer:** The Dietary Supplement Health and Education Act of 1994 (DSHEA) added Section 403(r)(6) to the FD&C Act. This section of the law states that a dietary supplement may bear certain statements on its label or in its labeling if the claim meets certain requirements. Section 101.93(f) simply restates part of the definition of the types of claims that may be made under Section 403(r)(6) of the FD&C Act. Section 101.93(f) reads:

(f) *Permitted structure/function statements.* Dietary supplement labels or labeling may, subject to the requirements in paragraphs (a) through (e) of this section, bear statements that describe the role of a nutrient or dietary ingredient intended to affect the structure or function in humans or that characterize the documented mechanism by which a nutrient or dietary ingredient acts to maintain such structure or function, provided that such statements are not disease claims under paragraph (g) (21 CFR 101.93). If the label or labeling of a product marketed as a dietary supplement bears a disease claim as defined in paragraph (g) of this section, the product will be subject to regulation as a drug unless the claim is an authorized health claim for which the product qualifies.

Section 403(r)(6) of the FD&C Act does not apply to conventional foods, however structure/function claims may be made on a conventional food provided the effects are derived from the nutritive value of the food.

<http://www.fda.gov/Food/LabelingNutrition/LabelClaims/StructureFunctionClaims/default.htm> and <http://www.fda.gov/Food/LabelingNutrition/LabelClaims/ucm111447>.

**S2. Are there other claims that can be made for dietary supplements under this section of the law?**

*Answer:* Yes. Section 403(r)(6) also states that dietary supplements can use claims about nutrient deficiency diseases (for example, vitamin C and scurvy) or that describe the effect of the dietary supplement on general well-being.

**S3. What requirements must I meet to make any of these types of claims for my dietary supplement?**

*Answer:* There are three requirements you must meet. First, the law says you can make these claims if you have substantiation that the claims are truthful and not misleading. You must have this substantiation before you make the claims. Second, you must notify FDA that you are using the claim within 30 days of first marketing your product. Third, the claim must include a mandatory disclaimer statement that is provided for in the law. Section 403(r)(6) of the FD&C Act.

**S4. Where can I find information on the mandatory disclaimer and the notification I need to send in?**

*Answer:* We have published regulations that describe exactly what the disclaimer must say and what you must include in your notification to us and where you must send it in the September 23, 1997 Federal Register (62 FR 49859 and 49883, respectively). These requirements can be found in 21 CFR 101.93(b) through (e) and 21 CFR 101.93(a), respectively.

**S5. How do I determine if a claim is a structure/function claim or a disease claim?**

*Answer:* It may not be possible always to draw a bright line between structure/function and disease claims. You should look at the objective evidence in your labeling to assess whether a claim explicitly or implicitly is a disease claim. For example, a statement may not mention a disease but may refer to identifiable characteristic signs or symptoms of a disease such that the intended use of the product to treat or prevent the disease may be inferred. It is important that you keep in mind two things. First, the context of the statement, decided from information on the label and in other labeling, will determine if the statement is considered to be a disease claim. Second, foods may not bear disease claims, explicit or implied, unless the claim has undergone premarket review by FDA and has been authorized or approved under the rules for health claims or drugs, as appropriate. To assist you in deciding whether a claim is or is not a disease claim, the new regulation contains a definition for disease, and then includes 10 criteria intended to help clarify the types of claims that may be made for dietary supplements without prior authorization or approval by FDA. We are providing that disease definition and a link to the 10 criteria in S7 below.

**S6. What is the definition of a disease?**

*Answer:* Section 101.93(g) defines disease as:

...damage to an organ, part, structure, or system of the body such that it does not function properly (e.g., cardiovascular disease), or a state of health leading to such dysfunctioning (e.g., hypertension); except that diseases resulting from essential nutrient deficiencies (e.g., scurvy, pellagra) are not included in this definition.

**S7. What are the criteria for determining if a statement is a disease claim?**

*Answer:* There are 10 criteria in the final rule entitled “Regulations on Statements Made for Dietary Supplements Concerning the Effect of the Product on the Structure or Function of the Body”, published on January 6, 2000 in the Federal Register (65 FR 1000-1050), that are useful in determining if a statement is a disease claim. These 10 criteria can be found in the:

**Structure/Function Claims Small Entity Compliance Guide:**

*<http://www.fda.gov/Food/GuidanceComplianceRegulatoryInformation/GuidanceDocuments/DietarySupplements/ucm103340>.*

## 9. APPENDIX A: DEFINITIONS OF NUTRIENT CONTENT CLAIMS

### Content Claims (“Free,” “Low,” “Reduced/Less”)

<i>Free</i>	<i>Low</i>	<i>Reduced/Less</i>	<i>Comments</i>
<p>Synonyms for “Free” “Zero”, “No”, “Without”, “Trivial Source of”, “Dietarily Insignificant Source of”</p> <p>Definitions for “Free” for meals and main dishes are the stated values per labeled serving but are not defined for calories</p>	<p>Synonyms for “Low”: “Little”, (“Few” for Calories), “Contains a Small Amount of”, “Low Source of”</p>	<p>Synonyms for “Reduced/Less”: “Lower” (“Fewer” for Calories)</p> <p>“Modified” may be used in statement of identity</p> <p>Definitions for meals and main dishes are same as for individual foods on a per 100 g basis</p>	<p>For “Free”, “Very Low”, or “Low”, must indicate if food meets a definition without benefit of special processing, alteration, formulation or reformulation; e.g., “broccoli, a fat-free food” or “celery, a low calorie food”</p>

### Definitions of Nutrient Content Claims

<i>Nutrient</i>	<i>Free</i>	<i>Low</i>	<i>Reduced/Less</i>	<i>Comments</i>
<p><b>Calories</b> 21 CFR 101.60(b)</p>	<p>Less than 5 cal per RACC and per labeled serving (b)(1)</p>	<p>40 cal or less per RACC (and per 50g if RACC is small) (b)(2)</p> <p>Meals and main dishes: 120 cal or less per 100 g (b)(3)</p>	<p>At least 25% fewer calories per RACC than an appropriate reference food (for meals and main dishes, at least 25% fewer calories per 100 g)</p> <p>Reference food may not be “Low Calorie</p> <p>Uses term “Fewer rather than “Less (b)(4) &amp; (5)</p>	<p>“Light” or “Lite”: if 50% or more of the calories are from fat, fat must be reduced by at least 50% per RACC. If less than 50% of calories are from fat, fat must be reduced at least 50% or calories reduced at least 1/3 per RACC 21 CFR 101.56(b)</p> <p>“Light” or “Lite” meal or main dish product meets definition for “Low Calorie” or “Low Fat” meal and is labeled to indicate which definition is met 21 CFR 101.56(d)</p> <p>For dietary supplements: Calorie claims can only be made when the reference product is greater than 40 calories per serving 21 CFR 101.60(a)(4)</p>

## Definitions of Nutrient Content Claims *continued*

<i>Nutrient</i>	<i>Free</i>	<i>Low</i>	<i>Reduced/Less</i>	<i>Comments</i>
<b>Total Fat</b> 21 CFR 101.62(b)	Less than 0.5 g RACC and per labeled serving (or for meals and main dishes, less than 0.5 g per labeled serving) (b)(1)  Contains no ingredient that is fat or understood to contain fat, except noted below (*).	3 g or less per RACC (and per 50 g if RACC is small) (b)(2)  Meals and main dishes: 3 g or less per 100 g and not more than 30% of calories from fat (b)(3)	At least 25% less fat per RACC than an appropriate reference food (or for meals and main dishes, at least 25% less fat per 100 g) (b)(4) & (5)  Reference food may not be “Low Fat”	“__% Fat Free”: may be used if food meets the requirements for “Low Fat” 21 CFR 101.62(b)(6)  100% Fat Free: food must be “Fat Free” (b)(6)(iii)  “Light”—see previous Calorie comments  For dietary supplements: total fat claims cannot be made for products that are 40 calories or less per serving 21 CFR 101.62(a)(4)

<i>Nutrient</i>	<i>Free</i>	<i>Low</i>	<i>Reduced/Less</i>	<i>Comments</i>
<b>Saturated Fat</b> 21 CFR 101.62(c)	Less than 0.5 g saturated fat and less than 0.5 g trans fatty acids per RACC and main dishes, less than 0.5 g saturated fat and trans fatty acids per labeled serving) (c)(1)  Contains no ingredient that is understood to contain saturated fat except as noted below (*)	1 g or less per RACC and 15% or less of calories from saturated fat (c)(2)  Meals and main dishes: 1 g or less per 100g and less than 10% of calories from saturated fat (c)(3)t	At least 25% less saturated fat per RACC than an appropriate reference food (or for meals and main dishes, at least 25% less saturated fat per 100 g) (c)(4) & (5)  Reference food may not be “Low Saturated Fat”	Next to all saturated fat claims, must declare the amount of cholesterol if 2 mg or more per RACC; and the amount of total fat if more than 3g per RACC (or 0.5 g or more of total fat per RACC for “Saturated Fat Free”) (or for meals and main dishes, per labeled serving) 21 CFR 101.62(c)  For dietary supplements: saturated fat claims cannot be made for products that are 40 calories or less per serving 21 CFR 101.62(a)(4)



## Definitions of Nutrient Content Claims *continued*

<i>Nutrient</i>	<i>Free</i>	<i>Low</i>	<i>Reduced/Less</i>	<i>Comments</i>
<b>Cholesterol</b> 21 CFR 101.62(d)	<p>Less than 2 mg per RACC and per labeled serving (or for meals and main dishes, less than 2 mg per labeled serving)</p> <p>Contains no ingredient that contains cholesterol except as noted below (*) (d)(1)</p>	<p>20 mg or less per RACC (and per 50 g of food if RACC is small) (d)(2)</p> <p>Meals and main dishes: 20 mg or less per 100 g (d)(3)</p>	<p>At least 25% less cholesterol per RACC than an appropriate reference food (or for meals and main dishes, at least 25% less cholesterol per 100 g) (d)(4) &amp; (5))</p> <p>Reference food may not be “Low Cholesterol”</p>	<p>Cholesterol claims only allowed when food contains 2 g or less saturated fat per RACC; or for meals and main dish products, per labeled serving size for “Free” claims or per 100 g for “Low” and “Reduced/Less” claims</p> <p>Must declare the amount of total fat next to cholesterol claim when fat exceeds 13 g per RACC and labeled serving (or per 50 g of food if RACC is small), or when the fat exceeds 19.5 g per labeled serving for main dishes or 26g for meal products</p> <p>For dietary supplements: cholesterol claims cannot be made for products that are 40 calories or less per serving</p>

<i>Nutrient</i>	<i>Free</i>	<i>Low</i>	<i>Reduced/Less</i>	<i>Comments</i>
<b>Sodium</b> 21 CFR 101.61	<p>Less than 5 mg per RACC and per labeled serving (or for meals and main dishes, less than 5 mg per labeled serving) (b)(1)</p> <p>Contains no ingredient that is sodium chloride or generally understood to contain sodium except as noted below (*)</p> <p>“Salt Free” must meet criterion for “Sodium Free” (c)(1)</p>	<p>140 mg or less per RACC (and per 50 g if RACC is small) (b)(4)</p> <p>Meals and main dishes: 140 mg or less per 100g (b)(5)</p> <p>“Very Low Sodium”: 35 mg or less per RACC (and per 50 g if RACC is small). For meals and main dishes: 35 mg or less per 100 g (b)(2) &amp; (3)</p>	<p>At least 25% less sodium per RACC than an appropriate reference food (or for meals and main dishes, at least 25% less sodium per 100 g)</p> <p>Reference food may not be “Low Sodium” (b)(6) &amp; (7)</p>	<p>“Light” (for sodium reduced 21 CFR products): if food is “Low Calorie” and “Low Fat” and sodium is reduced by at least 50%. 21 CFR 101.56(c)(1)</p> <p>“Light in Sodium”: if sodium is reduced by at least 50% per RACC. 21 CFR 101.56(c)(2)</p> <p>For meals and main dishes, “Light in Sodium” meets definition for “Low in Sodium” 21 CFR 101.56(d)(2)</p> <p>“No Salt Added” and “Unsalted” must declare “This is Not A Sodium Free Food” on information panel if food is not “Sodium Free” 21 CFR 101.61(c)(2)</p> <p>“Lightly Salted”: 50% less sodium than normally added to reference food and if not “Low Sodium”, so labeled on information panel 21 CFR 101.56(g)</p>

## Definitions of Nutrient Content Claims *continued*

<i>Nutrient</i>	<i>Free</i>	<i>Low</i>	<i>Reduced/Less</i>	<i>Comments</i>
<b>Sugars</b> 21 CFR 101.60(c)	<p>“Sugar Free”: Less than 0.5 g sugars per RACC and per labeled serving (or for meals and main dishes, less than 0.5 g per labeled serving) (c)(1)</p> <p>Contains no ingredient that is a sugar or generally understood to contain sugars except as noted below (*)</p> <p>Disclose calorie profile (e.g., “Low Calorie”)</p>	<p>Not Defined.</p> <p>May not be used</p>	<p>At least 25% less sugars per RACC than an appropriate reference food (or for meals and main dishes, at least 25% less sugar per 100g)</p> <p>May not use this claim on dietary supplements of vitamins and minerals (c)(5) &amp; (6)</p>	<p>“No Added Sugars” and “Without Added Sugars” are allowed if no sugar or sugar containing ingredient is added during processing. State if food is not “Low” or “Reduced Calorie” (c)(2)</p> <p>The terms “Unsweetened” and “No Added Sweeteners” remain as factual statements (c)(3)</p> <p>The claim does not refer to sugar alcohols, which may be present.</p> <p>For dietary supplements: “Sugar Free” and “No Added Sugar” may be used for vitamins and minerals intended to be used by infants and children less than 2 years of age. (c)(4)</p>

### Notes:

- \* Except if the ingredient listed in the ingredient statement has an asterisk that refers to footnote (e.g., “\* adds a trivial amount of fat”).
- RACC = Reference Amounts Customarily Consumed.
- Small RACC = Reference Amounts Customarily Consumed of 30 g or less or 2 tablespoons or less (for dehydrated foods that are typically consumed when rehydrated with water or a diluent containing an insignificant amount, as defined in 21 CFR 101.9(f)(1), of all nutrients per RACC, the per 50 g criterion refers to the prepared form of the food).
- When levels exceed: 13 g Total Fat, 4 g Saturated Fat, 60 mg Cholesterol, and 480 mg Sodium per RACC, per labeled serving or, for foods with small RACC, per 50 g, a disclosure statement is required as part of claim (e.g., “See nutrition information for \_\_\_ content” with the blank filled in with nutrient(s) that exceed the prescribed levels).
- The term “light” may be used to describe a physical or organoleptic attribute of the food if it clearly conveys the nature of the product, e.g., “light in color,” “light in texture.” 21 CFR 101.56(e)
- If there has been a long history of use of the term “light” associated with a product it may continue to be used, e.g., “light corn syrup,” “light brown sugar.” 21 CFR 101.56(f)

## 10. APPENDIX B: ADDITIONAL REQUIREMENTS FOR NUTRIENT CONTENT CLAIMS

### Relative Claims

To bear a relative claim about the level of a nutrient, the amount of that nutrient in the food must be compared to an amount of nutrient in an appropriate reference food as specified below (21 CFR 101.13(j)(1)):

“Light” -	(1) A food representative of the type of food bearing the claim (e.g., average value of top three brands or representative value from valid data base), and (2) Similar food (e.g., potato chips for potato chips)
-----------	--

“Reduced” and “Added” (or “Extra,” “Plus,” “Fortified,” - and “Enriched”) -	(1) An established regular product or average - representative product, and (2) Similar food. -
--	---

“More” and “Less” (or “Fewer”)	(1) An established regular product or average representative product, and (2) A dissimilar food in the same product category which may be generally substituted for the labeled food (e.g., potato chips for pretzels) or a similar food.
-----------------------------------	---

For all relative claims, the percent (or fraction) of change and identity of reference food must be declared immediately adjacent to the most prominent claim.

21 CFR 101.13(j)(2)(i) and 21 CFR 101.13(j)(2)(ii)

Quantitative comparison of the amount of the nutrient in the product per labeled serving with that in the reference food must be declared either adjacent to the claim or on the information panel. 21 CFR 101.13(j)(2)(iv)(A)

A relative claim for decreased levels of a nutrient may not be made if the nutrient content of the reference food meets the requirement for a “low” claim for that nutrient (e.g., 3 g fat or less). 21 CFR 101.13(j)(3)

### Other Nutrient Content Claims

Claim	Requirements
“High,” “Rich In,” or “Excellent Source Of”	Contains 20% or more of the DV per RACC. May be used on meals or main dishes to indicate that the product contains a food that meets the definition, but may not be used to describe the meal. 21 CFR 101.54(b)
“Good Source,” “Contains,” or “Provides”	10%-19% of the DV per RACC. These terms may be used on meals or main dishes to indicate that the product contains a food that meets the definition but may not be used to describe the meal. 21 CFR 101.54(e)

“More,” “Fortified,” “Enriched,” “Added,” “Extra,” or “Plus”	10% or more of the DV per RACC than an appropriate - reference food. May only be used for vitamins, minerals, - protein, dietary fiber, and potassium. <i>21 CFR 101.54(e)</i>
“Lean”	On seafood or game meat products that contain less than 10 g total fat, 4.5 g or less saturated fat, and less than 95 mg cholesterol per RACC and per 100g (for meals & main dishes, meets criteria per 100g and per labeled serving). On mixed dishes not measurable with a cup (as defined in <i>21 CFR 101.12(b)</i> in table 2) that contain less than 8 g total fat, 3.5 g or less saturated fat and less than 80 mg cholesterol per RACC. <i>21 CFR 101.62(e)(1)-(3)</i>
“Extra Lean” -	On seafood or game meat products that contains less than 5 g total fat, less than 2 g saturated fat and less than 95 mg cholesterol per RACC and per 100 g (for meals and main dishes, meets criteria per 100 g and per labeled serving). <i>21 CFR 101.62(e)(4) &amp; (5)</i>
“High Potency” -	May be used on foods to describe individual vitamins or minerals that are present at 100% or more of the RDI per RACC or on a multi-ingredient food product that contains 100% or more of the RDI for at least 2/3 of the vitamins and minerals with RDIs and that are present in the product at 2% or more of the RDI (e.g., “High potency multivitamin, multimineral dietary supplement tablets”). <i>21 CFR 101.54(f)</i>
“Modified”	May be used in statement of identity of a food that bears a relative claim (e.g., “Modified fat cheesecake, contains 35% less fat than our regular cheesecake.”) <i>21 CFR 101.13(k)</i>
“Fiber” Claims -	If a fiber claim is made and the food is not low in total fat, then the label must disclose the level of total fat per labeled serving. <i>21 CFR 101.54(d)(1)</i>
Claims using the term “antioxidant”	For claims characterizing the level of antioxidant nutrients in a food: <ol style="list-style-type: none"> <li>1. an RDI must be established for each of the nutrients that are the subject of the claim;</li> <li>2. each nutrient must have existing scientific evidence of antioxidant activity;</li> <li>3. the level of each nutrient must be sufficient to meet the definition for “high,” “good source,” or “more;” Beta-carotene may be the subject of an antioxi- dant claim when the level of vitamin A present as beta-carotene in the food is sufficient to qualify for the claim.</li> <li>4. Name(s) of nutrient(s) that is (are) the subject of the claim is (are) included as part of the claim. (e.g., high in antioxidant vitamins C &amp; E) <i>21 CFR 101.54(g)</i></li> </ol>

## Implied Claims

### *21 CFR 101.65*

- Claims about a food or ingredient or method of preparation that suggests that the nutrient or ingredient are absent or present in a certain amount or claims about a food that suggests a food may be useful in maintaining healthy dietary practices and which are made with an explicit claim (e.g. “healthy, contains 3 grams of fat”) are implied claims.
- Claims that a food contains or is made with an ingredient that is known to contain a particular nutrient may be made if product is “Low” in or a “Good Source” of the nutrient associated with the claim (e.g. “good source of oat bran”).
- Equivalence claims: “contains as much [nutrient] as a [food]” may be made if both reference food and labeled food are an equivalent “Good Source” of a nutrient on a per serving basis. (e.g. “Contains as much vitamin C as an 8 ounce glass of orange juice”). *21 CFR 101.65(c)(2)*
- The following label statements are generally not considered implied claims unless they are made in a nutrition context: 1) avoidance claims for religious, food intolerance, or other non-nutrition related reasons (e.g. “100% milk free”); 2) statements about non-nutritive substances (e.g. “no artificial colors”); 3) added value statements (e.g. “made with real butter”); 4) statements of identity (e.g. “corn oil” or “corn oil margarine”); and 5) special dietary statements made in compliance with a specific Part 105 provision.
- The term “healthy” and related terms (“health,” “healthful,” “healthfully,” “healthfulness,” “healthier,” “healthiest,” “healthily” and “healthiness”) may be used if the food meets the following requirements: *21 CFR 101.65(d)(2)*

## Conditions for the Use of “Healthy”

	<i>Individual Food</i>	<i>Seafood/Game Meat</i>	<i>Meal/Main Dish</i>
<b>TOTAL FAT</b>	low fat	< 5 g fat /RACC & /100g	low fat
<b>SATURATED FAT</b>	low sat fat	< 2 g sat fat /RACC & /100g	low sat fat
<b>SODIUM</b>	≤ 480 mg /RACC and / l.s.; or /50 g, if RACC is small	≤ 480 mg /RACC and /l.s.; or /50 g, if RACC is small	≤ 600 mg /l.s.
<b>CHOLESTEROL</b>	≤ disclosure level	< 95 mg /RACC & / 100 g	≤ 90 mg /l.s.
<b>BENEFICIAL NUTRIENTS</b>	Contains at least 10% of DV / RACC for vitamins A, C, calcium, iron, protein, or fiber except: raw fruits and vegetables; or a single ingredient or mixture of frozen or canned fruits and vegetables (may include ingredients whose addition does not change the nutrient profile of the fruit or vegetable); enriched cereal-grain products that conform to a standard of identity in 21 CFR 136, 137, or 139.	Contains at least 10% of DV /RACC for vitamins A, C, calcium, iron, protein, or fiber	Contains at least 10% of the DV /l.s. of two nutrients (for a main dish product) or of three nutrients (for a meal product) of vit. A, vit. C, calcium, iron, protein, or fiber.
<b>FORTIFICATION</b>	Per 21 CFR 104.20	Per 21 CFR 104.20	Per 21 CFR 104.20

**Note:** l.s. = labeled serving; RACC = Reference Amount Customarily Consumed per Eating Occasion; small RACC = 30 g or less, or 2 tablespoons or less

## Claims on Foods for Infants and Children Less than 2 Years of Age

Nutrient content claims are not permitted on foods intended specifically for infants and children less than 2 years of age except:

1. Claims describing the percentage of vitamins and minerals in a food in relation to a daily value. 21 CFR 101.13(q)(3)(i)
2. Claims on infant formulas provided for in Part 107. 21 CFR 101.13(b)
3. The terms “Unsweetened” and “Unsalted” as taste claims. 21 CFR 101.60(c)(3)
4. “Sugar Free” and “No Added Sugar” claims on dietary supplements only. 21 CFR 101.60(c)(4)



# 11. APPENDIX C: HEALTH CLAIMS

## Requirements for Health Claims Made in Labeling

<i>Approved Claims</i>	<i>Requirements for the Food</i>	<i>Claim Requirements</i>	<i>Model Claim Statements</i>
<p>Calcium and Osteoporosis and calcium, vitamin D, and osteoporosis</p> <p>(21 CFR 101.72)</p>	<p>For calcium and osteoporosis claim - high in calcium</p> <p>For calcium, vitamin D and osteoporosis claim - high in calcium and vitamin D</p> <p>- assimilable (Bioavailable)</p> <p>Supplements must disintegrate and dissolve, and</p> <p>Phosphorus content cannot exceed calcium content</p>	<p>The claim makes clear the importance of adequate calcium intake, or when appropriate, adequate calcium and vitamin D intake, throughout life, in a healthful diet, are essential to reduce osteoporosis risk. The claim does not imply that adequate calcium intake, or when appropriate, adequate calcium and vitamin D intake, is the only recognized risk factor for the development of osteoporosis.</p> <p>The claim does not attribute any degree of reduction in risk of osteoporosis to maintaining an adequate dietary calcium intake, or when appropriate, an adequate dietary calcium and vitamin D intake, throughout life.</p>	<p>Calcium and Osteoporosis: Adequate calcium throughout life, as part of a well-balanced diet, may reduce the risk of osteoporosis.</p> <p>Calcium, vitamin D and osteoporosis: Adequate calcium and vitamin D, as part of a well balanced diet, along with physical activity, may reduce the risk of osteoporosis.</p>
<p>Dietary Fat and Cancer</p> <p>(21 CFR 101.73)</p>	<p>Low fat</p> <p>(Fish &amp; game meats: “Extra lean”)</p>	<p><b>Required terms:</b></p> <p>“Total fat” or “Fat”</p> <p>“Some types of cancers” or “Some cancers”</p> <p>Does not specify types of fats or fatty acids that may be related to risk of cancer.</p>	<p>Development of cancer depends on many factors. A diet low in total fat may reduce the risk of some cancers.</p>

<i>Approved Claims</i>	<i>Requirements for the Food</i>	<i>Claim Requirements</i>	<i>Model Claim Statements</i>
Sodium and Hypertension  (21 CFR 101.74)	Low sodium	<b>Required terms:</b>  “Sodium”, “High blood pressure”  Includes physician statement (Individuals with high blood pressure should consult their physicians) if claim defines high or normal blood pressure	Diets low in sodium may reduce the risk of high blood pressure, a disease associated with many factors.
Dietary Saturated Fat and Cholesterol and risk of Coronary Heart Disease  (21 CFR 101.75)	Low saturated fat,  Low cholesterol and  Low fat	<b>Required terms:</b>  Saturated fat and cholesterol  “Coronary heart disease” or “heart disease”  Includes physician statement (individuals with elevated blood total—or LDL—cholesterol should consult their physicians) if claim defines high or normal blood total—and LDL—cholesterol.	While many factors affect heart disease, diets low in saturated fat and cholesterol may reduce the risk of this disease.
Fiber-Containing Grain Products, Fruits, and Vegetables and Cancer  (21 CFR 101.76)	A grain product, fruit, or vegetable that contains dietary fiber;  Low fat, and  Good source of dietary fiber (without fortification)	<b>Required terms:</b>  “Fiber”, “Dietary fiber”, or “Total dietary fiber”  “Some types of cancer” or “Some cancers”  Does not specify types of dietary fiber that may be related to risk of cancer.	Low fat diets rich in fiber-containing grain products, fruits, and vegetables may reduce the risk of some types of cancer, a disease associated with many factors.

<i>Approved Claims</i>	<i>Requirements for the Food</i>	<i>Claim Requirements</i>	<i>Model Claim Statements</i>
<p>Fruits, Vegetables and Grain Products that contain Fiber, particularly Soluble Fiber, and Risk of Coronary Heart Disease</p> <p>(21 CFR 101.77)</p>	<p>A fruit, vegetable, or grain product that contains fiber;</p> <p>Low saturated fat,</p> <p>Low cholesterol,</p> <p>Low fat,</p> <p>At least 0.6 grams of soluble fiber per RACC (without fortification), and,</p> <p>Soluble fiber content provided on label</p>	<p><b>Required terms:</b></p> <p>“Fiber”, “Dietary fiber”, “Some types of dietary fiber”, “Some dietary fibers”, or “Some fibers”</p> <p>“Saturated fat” and “Cholesterol”</p> <p>“Heart disease” or “Coronary heart disease”</p>	<p>Diets low in saturated fat and cholesterol and rich in fruits, vegetables, and grain products that contain some types of dietary fiber, particularly soluble fiber, may reduce the risk of heart disease, a disease associated with many factors.</p>
<p>Fruits and Vegetables and Cancer</p> <p>(21 CFR 101.78)</p>	<p>A fruit or vegetable,</p> <p>Low fat, and</p> <p>Good source (without fortification) of at least one of the following:</p> <ul style="list-style-type: none"> <li>• Vitamin A,</li> <li>• Vitamin C, or</li> <li>• Dietary fiber</li> </ul>	<p><b>Required terms:</b></p> <p>“Fiber”, “Dietary fiber”, or “Total dietary fiber”;</p> <p>“Total fat” or “Fat”,</p> <p>“Some types of cancer” or “Some cancers”</p> <p>Characterizes fruits and vegetables as “Foods that are low in fat and may contain Vitamin A, Vitamin C, and dietary fiber.”</p> <p>Characterizes specific food as a “Good source” of one or more of the following: Dietary fiber, Vitamin A, or Vitamin C.</p> <p>Does not specify types of fats or fatty acids or types of dietary fiber that may be related to risk of cancer.</p>	<p>Low fat diets rich in fruits and vegetables (foods that are low in fat and may contain dietary fiber, Vitamin A, or Vitamin C) may reduce the risk of some types of cancer, a disease associated with many factors. Broccoli is high in vitamin A and C, and it is a good source of dietary fiber.</p>

<i>Approved Claims</i>	<i>Requirements for the Food</i>	<i>Claim Requirements</i>	<i>Model Claim Statements</i>
Folate and Neural Tube Defects  (21 CFR 101.79)	<p>“Good source” of folate (at least 40 mcg folate per serving)</p> <p>Dietary supplements, or foods in conventional food form that are naturally good sources of folate (i.e., only non-fortified food in conventional food form)</p> <p>The claim shall not be made on products that contain more than 100% of the RDI for vitamin A as retinol or preformed vitamin A or vitamin D</p> <p>Dietary supplements shall meet USP standards for disintegration and dissolution or otherwise bioavailable</p> <p>Amount of folate required on Nutrition Label</p>	<p><b>Required terms:</b></p> <p><b>Nutrient:</b> “Folate”, “folic acid”, “folacin”, “folate, a B vitamin”, “folic acid, a B vitamin,” “folacin, a B vitamin.”</p> <p><b>Condition:</b> “neural tube defects”, “birth defects, spinal bifida, or anencephaly”, “birth defects of the brain or spinal cord, anencephaly or spinal bifida”, “spinal bifida and anencephaly, birth defects of the brain or spinal cord”; “brain or spinal cord birth defects.”</p> <p>Must also include information on the multifactorial nature of neural tube defects, and the safe upper limit of daily intake.</p>	<p>Healthful diets with adequate folate may reduce a woman's risk of having a child with a brain or spinal cord defect.</p>

<i>Approved Claims</i>	<i>Requirements for the Food</i>	<i>Claim Requirements</i>	<i>Model Claim Statements</i>
Dietary Non-cariogenic Carbohydrate Sweeteners and Dental Caries  (21 CFR 101.80)	Sugar free, and  When a fermentable carbohydrate is present, the food must not lower plaque pH below 5.7.  <b>Eligible substances</b>  1) The following sugar alcohols: xylitol, sorbitol, mannitol, maltitol, isomalt, lactitol, hydrogenated starch hydrolysates, hydrogenated glucose syrups, erythritol, or a combination of these.  2) The following sugars: D-tagatose and isomaltulose  3) The following non-nutritive sweetener: sucralose	<b>Required terms:</b>  “does not promote,” “may reduce the risk of,” “useful [or is useful] in not promoting” or “expressly [or is expressly] for not promoting” dental caries;  “dental caries” or “tooth decay.”  “sugar alcohol” or “sugar alcohols” or the name or names of the sugar alcohols  Note: D-tagatose may be identified as “tagatose”  When the substance that is the subject of the claim is a noncariogenic sugar (i.e., D-tagatose) the claim shall identify the substance as a sugar that, unlike other sugars, does not promote the development of dental caries.  Includes statement that frequent between meal consumption of foods high in sugars and starches can promote tooth decay.  Packages with less than 15 square inches of surface area available for labeling may use a shortened claim	<b>Full claim:</b> Frequent between-meal consumption of foods high in sugars and starches promotes tooth decay. The sugar alcohols in [name of food] do not promote tooth decay.  <b>Shortened claim (on small packages only):</b> Does not promote tooth decay.

Approved Claims	Requirements for the Food	Claim Requirements	Model Claim Statements
Soluble Fiber from Certain Foods and Risk of Coronary Heart Disease (21 CFR 101.81)	<p>Low saturated fat</p> <p>Low cholesterol</p> <p>Low fat, and</p> <p>The food product must include one or more of the following whole oat or barley foods: 1) oat bran, 2) rolled oats, 3) whole oat flour, 4) whole grain barley or dry milled barley, and the whole oat or barley foods must contain at least 0.75 g of soluble fiber per RACC of the food product; or</p> <p>Oatrim that contains at least 0.75 g of beta-glucan soluble per RACC of the food product; or</p> <p>Psyllium husk that contains at least 1.7 g of soluble fiber per RACC of food product.</p> <p><b>Eligible Sources of Soluble Fiber</b></p> <p>Beta-glucan soluble fiber from the following whole oat and barley sources:</p> <ol style="list-style-type: none"> <li>1) Oat bran</li> <li>2) Rolled Oats</li> <li>3) Whole Oat Flour</li> <li>4) Oatrim</li> <li>5) Whole Grain Barley and Dry Milled Barley</li> <li>6) Barley Betafiber</li> <li>7) Soluble fiber from psyllium husk with purity of no less than 95%</li> </ol> <p>The amount of soluble fiber per RACC must be declared in nutrition label.</p>	<p><b>Required terms:</b></p> <p>“Heart disease” or “coronary heart disease.”</p> <p>“Saturated fat” and “cholesterol.”</p> <p>In specifying the substance the claim uses the term “soluble fiber” qualified by the name of the eligible source of the soluble fiber, which is either whole oat or barley or psyllium seed husk.</p> <p>Claim specifies the daily dietary intake of the soluble fiber source necessary to reduce the risk of CHD</p> <p>Claim specifies the amount of soluble fiber in one serving of the product.</p> <p><b>Additional Required Label Statement</b></p> <p>Foods bearing a psyllium seed husk health claim must also bear a label statement concerning the need to consume them with adequate amounts of fluids; e.g., “NOTICE: This food should be eaten with at least a full glass of liquid. Eating this product without enough liquid may cause choking. Do not eat this product if your have difficulty in swallowing.</p> <p>(21 CFR 101.17(f))</p>	<p>Soluble fiber from foods such as [name of soluble fiber source, and, if desired, name of food product], as part of a diet low in saturated fat and cholesterol, may reduce the risk heart disease. A serving of [name of food product] supplies _ grams of the [necessary daily dietary intake for the benefit] soluble fiber from [name of soluble fiber source] necessary per day to have this effect. protein.</p>



<i>Approved Claims</i>	<i>Requirements for the Food</i>	<i>Claim Requirements</i>	<i>Model Claim Statements</i>
Soy Protein and Risk of Coronary Heart Disease  (21 CFR 101.82)	At least 6.25 g soy protein per RACC  Low saturated fat,  Low cholesterol, and  Low fat (except that foods made from whole soybeans that contain no fat in addition to that inherent in the whole soybean are exempt from the “low fat” requirement)	<b>Required terms:</b>  “Heart disease” or “coronary heart disease”  “Soy protein”  “Saturated fat” and “cholesterol”  Claim specifies daily dietary intake levels of soy protein associated with reduced risk  Claim specifies amount of soy protein in a serving of food	(1) 25 grams of soy protein a day, as part of a low in saturated fat and cholesterol, may reduce the risk of heart disease. A serving of [name of food] supplies ___ grams of soy protein.  (2) Diets low in saturated fat and cholesterol that include 25 grams of soy protein a day may reduce the risk of heart disease. One serving of [name of food] provides ___ grams of soy protein.

<i>Approved Claims</i>	<i>Requirements for the Food</i>	<i>Claim Requirements</i>	<i>Model Claim Statements</i>
*Plant Sterol/ stanol esters and Risk of Coronary Heart Disease  (21 CFR 101.83)	At least 0.65 g plant sterol esters per RACC of spreads and salad dressings, or  At least 1.7 g plant stanol esters per RACC of spreads, salad dressings, snack bars, and dietary supplements.  Low saturated fat,  Low cholesterol, and  Spreads and salad dressings that exceed 13 g fat per 50 g must bear the statement “see nutrition information for fat content”  Salad dressings are exempted from the minimum 10% DV nutrient requirement	<b>Required terms:</b>  “May” or “might” reduce the risk of CHD  “Heart disease” or “coronary heart disease”  “Plant sterol esters” or “plant stanol esters”; except “vegetable oil” may replace the term “plant” if vegetable oil is the sole source of the sterol/ stanol ester  Claim specifies plant stero/stanol esters are part of a diet low in saturated fat and cholesterol.  Claim does not attribute any degree of CHD risk reduction.  Claim specifies the daily dietary intake of plant sterol or stanol esters necessary to reduce CHD risk, and the amount provided per serving. Claim specifies that plant sterol or stanol esters should be consumed with two different meals each a day.	(1) Foods containing at least 0.65 gram per of vegetable oil sterol esters, eaten twice a day with meals for a daily total intake of least 1.3 grams, as part of a diet low in saturated fat and cholesterol, may reduce the risk of heart disease. A serving of [name of food] supplies __ grams of vegetable oil sterol esters.  (2) Diets low in saturated fat and cholesterol that include two servings of foods that provide a daily total of at least 3.4 grams of plant stanol esters in two meals may reduce the risk of heart disease. A serving of [name of food] supplies __ grams of plant stanol esters

\* FDA regulates the plant sterol/stanol esters and risk of coronary heart disease health claim according to the following requirements:

- 1) An interim final rule for the health claim that published on September 8, 2000 (65 FR 54686),
- 2) An enforcement discretion letter about expanded use of the interim final rule for the health claim,  
[http://www.fda.gov/Food/Labeling/Nutrition/LabelClaims/HealthClaimsMeetingSignificantScientificAgreementSSA/ucm074779.htm?utm\\_campaign=Google2&utm\\_source=fdaSearch&utm\\_medium=website&utm\\_term=phytosterols&utm\\_content=8](http://www.fda.gov/Food/Labeling/Nutrition/LabelClaims/HealthClaimsMeetingSignificantScientificAgreementSSA/ucm074779.htm?utm_campaign=Google2&utm_source=fdaSearch&utm_medium=website&utm_term=phytosterols&utm_content=8) and
- 3) A proposed rule for the health claim that published on December 8, 2010 (75 FR 76526).

## FDAMA (FDA Modernization Act) Health Claims (Health Claims Authorized)

### Based on an Authoritative Statement by Federal Scientific Bodies)

<i>Approved Claims</i>	<i>Food Requirements</i>	<i>Claim Requirement</i>	<i>Model Claim Statements</i>
Whole Grain Foods and Risk of Heart Disease and Certain Cancers  (Docket No. 1999P-2209)	Contains 51 percent or more whole grain ingredients by weight per RACC, and  Dietary fiber content at least: <ul style="list-style-type: none"> <li>• 3.0 g per RACC of 55 g</li> <li>• 2.8 g per RACC of 50 g</li> <li>• 2.5 g per RACC of 45 g</li> <li>• 1.7 g per RACC of 35 g</li> </ul>	<b>Required wording of the claim:</b>  “Diets rich in whole grain foods and other plant foods and low in total fat, saturated fat, and cholesterol may reduce the risk of heart disease and some cancers.”	NA
Whole Grain Foods with Moderate Fat Content and Risk of Heart Disease  (Docket No. 03Q-0547)	Contains 51 percent or more whole grain ingredients by weight per RACC, and  Dietary fiber content at least: <ul style="list-style-type: none"> <li>• 3.0 g per RACC of 55 g</li> <li>• 2.8 g per RACC of 50 g</li> <li>• 2.5 g per RACC of 45 g</li> <li>• 1.7 g per RACC of 35 g</li> </ul>	<b>Required wording of the claim:</b>  “Diets rich in whole grain foods and other plant foods, and low in total fat, saturated fat, and cholesterol may help reduce the risk of heart disease.”	NA
Potassium and the Risk of High Blood Pressure and Stroke  (Docket No. 2000Q-1582)	Good source of potassium  Low sodium  Low total fat  Low saturated fat  Low cholesterol	<b>Required wording of the claim:</b>  “Diets containing foods that are a good source of potassium and that are low in sodium may reduce the risk of high blood pressure and stroke.”	NA
Fluoridated Water and Reduced Risk of Dental Caries  (Docket No. 2006Q-0418)	Bottled water meeting the standards of identity and quality set forth in <i>21 CFR 165.110</i>  Meet all general requirements for health claims in (21 CFR 101.14) with the exception of the minimum nutrient contribution ( <i>21 CFR 101.14(e)(6)</i> ),  Total Fluoride: >0.6 to 1.0 mg/L  Excluding bottled water products specifically marketed for use by infants	<b>Required wording of the claim:</b>  “Drinking fluoridated water may reduce the risk of [dental caries or tooth decay]”.	NA

<i>Approved Claims</i>	<i>Food Requirements</i>	<i>Claim Requirement</i>	<i>Model Claim Statements</i>
Saturated Fat, Cholesterol, and Trans Fat, and Reduced Risk of Heart Disease <i>(Docket No. 2006Q-0458)</i>	Low saturated fat Low cholesterol Bear quantitative trans fat labeling Contains less than 0.5 g trans fat per RACC Contains less than 6.5 g total fat	<b><i>Required wording of the claim:</i></b> “Diets low in saturated fat and cholesterol, and as low as possible in trans fat, may reduce the risk of heart disease.”	NA
Substitution of Saturated Fat in the Diet with Unsaturated Fatty Acids and Reduced Risk of Heart Disease <i>(Docket No. 2007Q-0192)</i>	Low fat Low cholesterol Meets all general requirements for health claims in <i>21 CFR 101.14</i>	<b><i>Required wording of the claim:</i></b> “Replacing saturated fat with similar amounts of unsaturated fats may reduce the risk of heart disease. To achieve this benefit, total daily calories should not increase.”	NA

## 12. APPENDIX D: QUALIFIED HEALTH CLAIMS

FDA will exercise enforcement discretion for qualified health claims when the claim meets all general requirements of 21 CFR 101.14, except for the requirements that the claim meet the significant scientific agreement standard and that the claim be made in accordance with an authorizing regulation. Other factors that FDA will consider in exercising enforcement discretion are listed in the following qualified health claim table.

<i>Qualified Health Claims</i>	<i>Eligible Foods</i>	<i>Factors for Exercising Enforcement Discretion</i>	<i>Claim Statements</i>
<b>0.8 mg Folic Acid &amp; Neural Tube Birth Defects</b>  Docket No. 1991N-100H  10/10/2000 enforcement discretion letter  04/03/2001 clarification letter  Note: there also is a folic acid/neural tube defect health claim authorized by regulation (see 21 CFR 101.79).	Dietary supplements containing folic acid	The disclaimer (i.e., FDA does not endorse this claim...) is placed immediately adjacent to and directly beneath the claim (i.e., 0.8 mg folic acid ...), with no intervening material, in the same size, typeface, and contrast as the claim.	0.8 mg folic acid in a dietary supplement is more effective in reducing the risk of neural tube defects than a lower amount in foods in common form. FDA does not endorse this claim. Public health authorities recommend that women consume 0.4 mg folic acid daily from fortified foods or dietary supplements or both to reduce the risk of neural tube defects.

<i>Qualified Health Claims</i>	<i>Eligible Foods</i>	<i>Factors for Exercising Enforcement Discretion</i>	<i>Claim Statements</i>
<p><b>B Vitamins &amp; Vascular Disease</b></p> <p>Docket No. 1999P-3029</p> <p>11/28/2000 enforcement discretion letter</p> <p>05/15/2001 clarification letter</p>	<p>Dietary supplements containing vitamin B6, B12, and/or folic acid</p>	<p>The disclaimer (i.e., FDA evaluated the above claim...) must be immediately adjacent to and directly beneath the first claim (i.e., As part of a well-balanced diet...) with no intervening material that separates the claim from the disclaimer, and the second sentence must be in the same size, type face and contrast as the first sentence.</p> <p>Products that contain more than 100 percent of the Daily Value (DV) of folic acid (400 micrograms), when labeled for use by adults and children 4 or more years of age, must identify the safe upper limit of daily intake with respect to the DV. The folic acid safe upper limit of daily intake value of 1,000 micrograms (1 mg) may be included in parentheses.</p> <p>The claim does not suggest a level of vitamins B6, B12, and/or folic acid as being useful in achieving the claimed effect.</p> <p>Dietary supplements containing folic acid must meet the United States Pharmacopeia (USP) standards for disintegration and dissolution, except that if there are no applicable USP standards, the folate in the dietary supplement shall be shown to be bioavailable under the conditions of use stated on the product label.</p>	<p>As part of a well-balanced diet that is low in saturated fat and cholesterol, Folic Acid, Vitamin B6 and Vitamin B12 may reduce the risk of vascular disease. FDA evaluated the above claim and found that, while it is known that diets low in saturated fat and cholesterol reduce the risk of heart disease and other vascular diseases, the evidence in support of the above claim is inconclusive.</p>

<i>Qualified Health Claims</i>	<i>Eligible Foods</i>	<i>Factors for Exercising Enforcement Discretion</i>	<i>Claim Statements</i>
<p><b>Selenium &amp; Cancer</b></p> <p><i>Docket No.</i> 2002P-0457</p> <p>02/21/2003 enforcement discretion letter</p> <p>04/28/2003 clarification letter</p>	<p>Dietary supplements containing selenium</p>	<p>The disclaimer (i.e., Some scientific evidence suggests...) is placed immediately adjacent to and directly beneath the claim (i.e., Selenium may reduce the risk), with no intervening material, in the same size, typeface, and contrast as the claim itself.</p> <p>The supplement does not recommend or suggest in its labeling, or under ordinary conditions of use, a daily intake exceeding the Tolerable Upper Intake Level established by the National Academy of Sciences/ Institute of Medicine for selenium (400 micro-grams per day).</p> <p>Paragraph 101.14(d)(2)(vii) requires that the dietary supplement bearing the claim meet the nutrient content claim definition for high (i.e., 20% or more of the daily value (DV) per RACC). 20% DV for selenium is 14 micrograms.</p>	<p>(1) Selenium may reduce the risk of certain cancers. Some scientific evidence suggests that consumption of selenium may reduce the risk of certain forms of cancer. However, FDA has determined that this evidence is limited and not conclusive. or,</p> <p>(2) Selenium may produce anti-carcinogenic effects in the body. Some scientific evidence suggests that consumption of selenium may produce anticarcinogenic effects in the body. However, FDA has determined that this evidence is limited and not conclusive.</p>



<b>Qualified Health Claims</b>	<b>Eligible Foods</b>	<b>Factors for Exercising Enforcement Discretion</b>	<b>Claim Statements</b>
<b>Antioxidant Vitamins &amp; Cancer</b>  Docket No. 1991N-0101  04/01/2003 enforcement discretion letter	Dietary supplements containing vitamin E and/or vitamin C	<p>The disclaimer (i.e., ...evidence is limited and not conclusive) is placed immediately adjacent to and below the claim, with no intervening material, in the same size, typeface, and contrast as the claim itself.</p> <p>The supplement does not recommend or suggest in its labeling, or under ordinary conditions of use, a daily intake exceeding the Tolerable Upper Intake Levels established by the Institute of Medicine for vitamin C (2000 mg per day) or for vitamin E (1000 mg per day).</p> <p>Paragraph 101.14(d)(2)(vii) requires that the food bearing the claim meet the nutrient content claim definition for high (i.e., 20% or more of the daily value (DV) per RACC). 20% DV for vitamin C is 12 mg; 20% DV for vitamin E is 6 IU.</p>	<p>(1) Some scientific evidence suggests that consumption of antioxidant vitamins may reduce the risk of certain forms of cancer. However, FDA has determined that this evidence is limited and not conclusive. or,</p> <p>(2) Some scientific evidence suggests that consumption of antioxidant vitamins may reduce the risk of certain forms of cancer. However, FDA does not endorse this claim because this evidence is limited and not conclusive. or,</p> <p>(3) FDA has determined that although some scientific evidence suggests that consumption of antioxidant vitamins may reduce the risk of certain forms of cancer, this evidence is limited and not conclusive.</p>
<b>Phosphatidylserine &amp; Cognitive Dysfunction and Dementia</b>  Docket No. 2002P-0413  02/24/2003 enforcement discretion letter  05/13/2003 clarification letter  11/24/2004 updated letter	Dietary supplements containing soy-derived phosphatidylserine	<p>The disclaimer (i.e., Very limited and preliminary scientific research...) is placed immediately adjacent to and directly beneath the claim (i.e., Phosphatidylserine may reduce...), with no intervening material, in the same size, typeface, and contrast as the claim itself.</p> <p>The claim does not suggest a level of phosphatidylserine as being useful in achieving the claimed effect.</p> <p>The soy-derived phosphatidylserine used is of very high purity.</p>	<p>(1) Consumption of phosphatidylserine may reduce the risk of dementia in the elderly. Very limited and preliminary scientific research suggests that phosphatidylserine may reduce the risk of dementia in the elderly. FDA concludes that there is little scientific evidence supporting this claim. or,</p> <p>(2) Consumption of phosphatidylserine may reduce the risk of cognitive dysfunction in the elderly. Very limited and preliminary scientific research suggests that phosphatidylserine may reduce the risk of cognitive dysfunction in the elderly. FDA concludes that there is little scientific evidence supporting this claim.</p>

<i>Qualified Health Claims</i>	<i>Eligible Foods</i>	<i>Factors for Exercising Enforcement Discretion</i>	<i>Claim Statements</i>
<p><b>Nuts &amp; Heart Disease</b></p> <p>Docket No. 2002P-0505</p> <p>07/14/2003 enforcement discretion letter</p>	<p>(1) Whole or chopped nuts listed below that are raw, blanched, roasted, salted, and/or lightly coated and/or flavored; any fat or carbohydrate added in the coating or flavoring must meet the 21 CFR 101.9(f)(1) definition of an insignificant amount.</p> <p>(2) Nut-containing products other than whole or chopped nuts that contain at least 11 g of one or more of the nuts listed below per RACC.</p> <p>(3) Types of nuts eligible for this claim are restricted to almonds, hazelnuts, peanuts, pecans, some pine nuts, pistachio nuts, and walnuts. Types of nuts on which the health claim may be based is restricted to those nuts that were specifically included in the health claim petition, but that do not exceed 4 g saturated fat per 50 g of nuts.</p>	<p>Whole or chopped nuts</p> <p>Whole or chopped nuts do not need to comply with the total fat disqualifying level in 21 CFR 101.14(a)(4).</p> <p>Only walnuts do not need to comply with the requirement in § 101.14(e)(6) that the food contain a minimum of 10 percent of the Daily Value per RACC of vitamin A, vitamin C, iron, calcium, protein, or dietary fiber.</p> <p>Where the claim is used on whole or chopped nuts, the disclosure statement (see nutrition information...) must be placed immediately adjacent to and directly beneath the claim, with no intervening material, in the same size, typeface, and contrast as the claim itself.</p> <p>Nuts bearing the claim must comply with the 21 CFR 101.14(a)(4) saturated fat disqualifying level (4 g saturated fat per 50 g nuts).</p> <p><b>Nut-containing products</b></p> <p>Nut-containing products bearing the claim must comply with all the 21 CFR 101.14(a)(4) disqualifying levels which are 13 g total fat, 4 g saturated fat, 60 mg of cholesterol, and 480 mg of sodium per RACC.</p> <p>The claim applies only to types of nuts that do not exceed the 21 CFR 101.14(a)(4) disqualifying nutrient level for saturated fat (4 g saturated fat per 50 g nuts).</p> <p>Nut-containing products bearing the claim must comply with the 21 CFR 101.62(c)(2) definition of a low saturated fat food and the 21 CFR 101.62(d)(2) definition of a low cholesterol food.</p> <p>Nut-containing products bearing the claim must comply with the 21 CFR 101.14(e)(6) requirement that the food contain a minimum of 10 percent of the Daily Value per RACC of vitamin A, vitamin C, iron, calcium, protein, or dietary fiber prior to any nutrient addition.</p>	<p>Scientific evidence suggests but does not prove that eating 1.5 ounces per day of most nuts [such as name of specific nut] as part of a diet low in saturated fat and cholesterol may reduce the risk of heart disease. [See nutrition information for fat content.]</p> <p>Note: The bracketed phrase naming a specific nut is optional. The bracketed fat content disclosure statement is applicable to a claim made for whole or chopped nuts, but not a claim made for nut-containing products.</p>

<i>Qualified Health Claims</i>	<i>Eligible Foods</i>	<i>Factors for Exercising Enforcement Discretion</i>	<i>Claim Statements</i>
<p><b>Walnuts &amp; Heart Disease</b></p> <p>Docket No. 2002P-029</p> <p>03/09/2004 enforcement discretion letter</p>	<p>Whole or chopped walnuts</p>	<p>Walnuts do not need to comply with the total fat disqualifying level in 21 CFR 101.14(a)(4).</p> <p>Walnuts do not need to comply with the requirement in § 101.14(e)(6) that the food contain a minimum of 10 percent of the Daily Value per RACC of vitamin A, vitamin C, iron, calcium, protein, or dietary fiber.</p> <p>The disclosure statement about total fat content (i.e., See nutrition information for fat content) is placed immediately following the claim, with no intervening material, in the same size, typeface, and contrast as the claim itself.</p>	<p>Supportive but not conclusive research shows that eating 1.5 ounces per day of walnuts, as part of a low saturated fat and low cholesterol diet and not resulting in increased caloric intake, may reduce the risk of coronary heart disease. See nutrition information for fat [and calorie] content.</p> <p>Notes: The bracketed phrase “and calorie” is optional in that FDA does not intend for the presence or absence of such phrase to be a factor in whether it considers enforcement discretion for the use of the qualified health claim. FDA considered this additional information beneficial to consumers to heighten their awareness of the caloric contribution from walnuts and encourages companies to include it in product labeling.</p>

<i>Qualified Health Claims</i>	<i>Eligible Foods</i>	<i>Factors for Exercising Enforcement Discretion</i>	<i>Claim Statements</i>
<p><b>Omega-3 Fatty Acids &amp; Coronary Heart Disease</b></p> <p>Docket No. 2003Q-0401</p> <p>09/08/2004 enforcement discretion letter - Wellness Petition</p> <p>09/08/2004 enforcement discretion letter - Martek Petition</p>	<p>Conventional foods and dietary supplements that contain EPA and DHA omega-3 fatty acids.</p>	<p>Dietary supplements should not recommend or suggest in their labeling a daily intake exceeding 2 grams of EPA and DHA</p> <p><b>Total fat content</b></p> <p>Dietary supplements that weigh 5 g or less per RACC (RACC for dietary supplement is labeled serving size) are exempted from the total fat disqualifying level, but if dietary supplements that weigh 5 g or less per RACC exceed the total fat disqualifying level (13.0 g per 50 g) the disclosure statement (i.e., “See nutrition information for total fat content”) must be placed immediately adjacent to the health claim. Dietary supplements that weigh more than 5 g per RACC must not exceed the total fat disqualifying level (13.0 g per RACC and per 50 g if RACC is ≤ 30 g or ≤ 2 tbsp). (See “<i>Qualified Health Claims Subject to Enforcement Discretion, Omega-3 Fatty Acids and Coronary Heart Disease</i>” and the enforcement discretion letter for <i>Omega-3 Fatty Acids and Coronary Heart Disease</i>)</p> <p>Fish (i.e., “products that are essentially all fish”) may not exceed 16.0 g total fat per RACC. Fish with a total fat content greater than 13.0 g per RACC must include “See nutrition information for total fat content” with the health claim. The “products that are essentially all fish” include fish without any added ingredients and fish with a small amount of added fat or carbohydrate that meets the definition of an insignificant amount in 21 CFR 101.9(f)(1). Examples of these products are raw fish, boiled fish, and broiled fish.</p>	<p>Supportive but not conclusive research shows that consumption of EPA and DHA omega-3 fatty acids may reduce the risk of coronary heart disease. One serving of [Name of the food] provides [ ] gram of EPA and DHA omega-3 fatty acids. [See nutrition information for total fat, saturated fat, and cholesterol content.]</p> <p>Note: Dietary supplements may declare the amount of EPA and DHA per serving in “Supplement Facts,” instead of making the declaration in the claim.</p>

(Continued)

**Conventional foods** other than fish may not exceed the total fat disqualifying levels. For individual foods, the total fat disqualifying level is 13.0 g per RACC and per 50 g if RACC is  $\leq 30$  g or  $\leq 2$  tbsp. The total fat disqualifying level is 26.0 g per label serving size for meal products and 19.5 g per label serving size for main dish products.

**Saturated fat content**

Dietary supplements must meet the criterion for low saturated fat with regard to the saturated fat content ( $\leq 1$  g per RACC) but not with regard to the no more than 15 percent calories from saturated fat criterion.

Fish may not exceed the saturated fat disqualifying level of 4.0 g per RACC (or 4.0 g per 50 g if RACC is  $\leq 30$  g or  $\leq 2$  tbsp).

Conventional foods other than fish must meet the criteria for low saturated fat ( $\leq 1$  g per RACC and no more than 15 percent of calories from saturated fat for individual foods,  $\leq 1$  g per 100 g and less than 10 percent calories from saturated fat for meal products and main dish products). There is an error in the enforcement discretion letters in the section of “low saturated fat,” stating that meal products and main dishes meet all criteria specified for the “low saturated fat” criteria (21 CFR 101.62(c)(2)). The CFR number should be (21 CFR 101.62(c)(3)).

**Cholesterol content**

Dietary supplements that weigh 5 g or less per RACC are exempt from the cholesterol disqualifying level (60 mg per 50 g), but those that exceed the cholesterol disqualifying level must include “See nutrition information for cholesterol content” with the qualified health claim. Dietary supplements that weigh more than 5 g per RACC must meet the criterion for low cholesterol ( $\leq 20$  mg per 50g).

(Continued)

Qualified Health Claims	Eligible Foods	Factors for Exercising Enforcement Discretion	Claim Statements
		<p>Fish must meet the extra lean criterion with regard to cholesterol content (&lt; 95 mg per RACC and per 100 g, whichever is greatest), but not with regard to saturated fat content. Fish with cholesterol content greater than 60 mg per RACC must include “See nutrition information for cholesterol content” with the qualified health claim.</p>	
		<p><b>Conventional foods</b> other than fish must meet the low cholesterol criterion (21 CFR 101.62(d)(2)). See 21 CFR 101.62(d)(2) for the low cholesterol criterion specific for individual foods, meal products, and main dish products.</p>	
		<p><b>Sodium</b> All conventional foods and dietary supplements must meet the sodium disqualifying level (<math>\leq</math> 480 mg per RACC and per 50 g if RACC is <math>\leq</math> 30 g or <math>\leq</math> 2 tbsp for individual foods, <math>\leq</math> 960 mg per label serving size for meal products, <math>\leq</math> 720 mg per label serving size for main dish products).</p>	
		<p><b>The 10 percent minimum nutrient requirement</b> All conventional foods must meet the 10 percent minimum nutrient requirement (Vitamin A 500 IU, Vitamin C 6 mg, Iron 1.8 mg, Calcium 100 mg, Protein 5 g, Fiber 2.5 g per RACC), prior to any nutrient addition. The 10 percent minimum nutrient requirement does not apply to dietary supplements (21 CFR 101.14(e)(6)).</p>	

Qualified Health Claims	Eligible Foods	Factors for Exercising Enforcement Discretion	Claim Statements
<b>Monounsaturated Fatty Acids From Olive Oil and Coronary Heart Disease</b>	All products that are essentially pure olive oil and labeled as such (see * for definitions)	Olive oil, vegetable oil spreads, dressings for salads, shortenings and olive-oil containing foods do not need to comply with the total fat disqualifying level in 21 CFR 101.14(a)(4).	Limited and not conclusive scientific evidence suggests that eating about 2 tablespoons (23 grams) of olive oil daily may reduce the risk of coronary heart disease due to the monounsaturated fat in olive oil. To achieve this possible benefit, olive oil is to replace a similar amount of saturated fat and not increase the total number of calories you eat in a day. One serving of this product contains [x] grams of olive oil.
Docket No. 2003Q-0559  11/01/2004 enforcement discretion letter	Dressings for salads (i.e. salad dressings) that contain 6 g or more olive oil per Reference Amount Customarily Consumed (RACC), are low in cholesterol (21 CFR 101.62(d)(2)), and do not contain more than 4 g of saturated fat per 50 g.	The requirement that the food comply with the 50 gram-criterion of the saturated fat disqualifying level (21 CFR 101.14(e)(3)) does not apply to olive oil, vegetable oil spreads, and shortenings.	Note: The last sentence of the claim “One serving of this product contains [x] grams of olive oil.” is optional when the claim is used on the label or in the labeling of olive oil.
	Vegetable oil spreads that contain 6 g or more olive oil per RACC, are low in cholesterol (21 CFR 101.62(d)(2)) and do not contain more than 4 g of saturated fat per RACC.	The requirement that the food contain a minimum of 10 percent of the Daily Value per RACC of at one of the following: vitamin A, vitamin C, iron, calcium, protein, or dietary fiber per RACC (21 CFR 101.14(e)(6)) does not apply to olive oil, dressings for salads, and shortenings.	*(1) Olive oil means virgin olive oil, or blends of virgin olive oil and refined olive oil; where virgin olive oil is the oil resulting from the first pressing of olives and is suitable for human consumption without further processing and refined olive oil is the oil obtained from subsequent pressings and which is suitable for human consumption by refining processes which neutralize the acidity or remove particulate matter.
	Olive oil-containing foods that contain 6 g or more olive oil per RACC, are low in cholesterol (21 CFR 101.62(d)(2)), contain at least 10% of either vitamin A, vitamin C, iron, calcium, protein or dietary fiber.	When the total fat disqualifying level is exceeded in vegetable oil spreads, dressings for salads, shortenings, or olive-oil containing foods the disclosure statement (i.e., See nutrition information for saturated fat content) must be placed immediately following the claim, with no intervening material, in the same size, typeface, and contrast as the claim itself.	(2) Vegetable oil spread means margarine (21 CFR 166.110) and margarine-like products.
		When the food does not meet the definition of low saturated fat (21 CFR 101.62(c)(2)) the disclosure statement (i.e., See nutrition information for saturated fat content) must be placed immediately following the claim, with no intervening material, in the same size, typeface, and contrast as the claim itself.	(3) “dressings for salads” means dressings for salads formulated to contain olive oil.
		If both of the above two conditions are met the disclosure statements for total fat and saturated fat can be combined (i.e., See nutrition information for total and saturated fat content).	(4) “shortenings” means vegetable oil shortenings, formulated to contain olive oil.
			(5) Olive oil-containing foods means foods, such as sauces or baked goods, excluding olive oil, vegetable oil spreads, dressings for salads, and shortenings.

(Continued)



Qualified Health Claims	Eligible Foods	Factors for Exercising Enforcement Discretion	Claim Statements
	<p>If the RACC of the olive oil-containing food is greater than 30 g the food cannot contain more than 4 g of saturated fat per RACC and if the RACC of the olive oil-containing food is 30 g or less the food cannot contain more than 4 g of saturated fat per 50 g.</p>		
	<p>Shortenings that contain 6 g or more olive oil per RACC and are low in cholesterol (21 CFR 101.62 (d)(2)) and do not contain more than 4 g of saturated fat per RACC.</p>		
	<p>Meal products (21 CFR 101.13 (l)) or Main dish products (21 CFR 101.13(m)) are not eligible for the claim.</p>		

<i>Qualified Health Claims</i>	<i>Eligible Foods</i>	<i>Factors for Exercising Enforcement Discretion</i>	<i>Claim Statements</i>
<p><b>Green Tea &amp; Cancer</b></p> <p><i>Docket No. FDA-2004-Q-0427</i> 02/24/2011 enforcement discretion letter</p>	<p>Green tea and conventional foods and dietary supplements that contain green tea</p>	<p>Green tea does not exceed the disqualifying nutrient levels for total fat, saturated fat, cholesterol, and sodium specified in <i>21 CFR 101.14(a)(4)</i>.</p> <p>FDA intends to consider the exercise of its enforcement discretion for qualified health claims for green tea and breast cancer and for green tea and prostate cancer to be used on the label or in the labeling of green tea-containing foods when the food does not exceed any of the disqualifying nutrient levels for fat, saturated fat, cholesterol, and sodium.</p> <p>FDA intends to consider the exercise of its enforcement discretion for green tea that does not meet the 10% minimum nutrient content requirement in <i>21 CFR 101.14(e)(6)</i>.</p> <p>FDA does not intend to consider the exercise of its enforcement discretion for green tea-containing foods that do not meet the requirements of <i>21 CFR 101.14(e)(6)</i>.</p>	<p>(1) Green tea may reduce the risk of breast or prostate cancer although the FDA has concluded that there is very little scientific evidence for this claim.</p> <p>(2) Green tea may reduce the risk of breast or prostate cancer. FDA has concluded that there is very little scientific evidence for this claim.</p>
<p><b>Chromium Picolinate &amp; Diabetes</b></p> <p><i>Docket No. 2004Q-0144</i> 08/25/2005 enforcement discretion letter</p>	<p>Dietary supplements containing chromium</p>	<p>Dietary supplement containing chromium must meet or exceed the requirement for a “high” level of chromium as defined in <i>21 CFR 101.54(b)</i> (i.e., 24 mg or more per RACC under the current regulation) for FDA to exercise enforcement discretion.</p>	<p>One small study suggests that chromium picolinate may reduce the risk of insulin resistance, and therefore possibly may reduce the risk of type 2 diabetes. FDA concludes, however, that the existence of such a relationship between chromium picolinate and either insulin resistance or type 2 diabetes is highly uncertain.</p>

<i>Qualified Health Claims</i>	<i>Eligible Foods</i>	<i>Factors for Exercising Enforcement Discretion</i>	<i>Claim Statements</i>
<p><b>Calcium and Colon/Rectal Cancer &amp; Calcium and Recurrent Colon/Rectal Polyps</b></p> <p>Docket No. 2004Q-0097</p> <p>10/12/2005 enforcement discretion letter</p>	<p>Dietary supplements containing calcium</p>	<p>The dietary supplement must meet or exceed the requirement for a “high” level of calcium as defined in <i>21 CFR 101.54(b)</i> (i.e., 200 mg or more calcium per RACC)</p> <p>The calcium content of the dietary supplement must be assimilable (i.e., bioavailable) (<i>21 CFR 101.72(c)(ii)(B)</i>), and meet the United States Pharmacopeia (U.S.P.) standards for disintegration and dissolution applicable to their component calcium salts. For dietary supplements for which no U.S.P. standards exist, the dietary supplement must exhibit appropriate assimilability under the conditions of use stated on the product label (<i>21 CFR 101.72(c)(ii)(C)</i>).</p>	<p><b>Colon/Rectal Cancer:</b> Some evidence suggests that calcium supplements may reduce the risk of colon/rectal cancer, however, FDA has determined that this evidence is limited and not conclusive.</p> <p><b>Recurrent Colon Polyps:</b> Very limited and preliminary evidence suggests that calcium supplements may reduce the risk of colon/rectal polyps. FDA concludes that there is little scientific evidence to support this claim.</p>
<p><b>Calcium &amp; Hypertension, Pregnancy-Induced Hypertension, and Preeclampsia</b></p> <p>Docket No. 2004Q-0098</p> <p>10/12/2005 enforcement discretion letter</p>	<p>Dietary supplements containing calcium</p>	<p>The dietary supplement must meet or exceed the requirement for a “high” level of calcium as defined in <i>21 CFR 101.54(b)</i> (i.e., 200 mg or more calcium per RACC)</p> <p>The calcium content of the dietary supplement must be assimilable (i.e., bioavailable) (<i>21 CFR 101.72(c)(ii)(B)</i>), and meet the United States Pharmacopeia (U.S.P.) standards for disintegration and dissolution applicable to their component calcium salts. For dietary supplements for which no U.S.P. standards exist, the dietary supplement must exhibit appropriate assimilability under the conditions of use stated on the product label (<i>21 CFR 101.72(c)(ii)(C)</i>).</p>	<p><b>Hypertension:</b> Some scientific evidence suggests that calcium supplements may reduce the risk of hypertension. However, FDA has determined that the evidence is inconsistent and not conclusive.</p> <p><b>Pregnancy-Induced Hypertension:</b> Four studies, including a large clinical trial, do not show that calcium supplements reduce the risk of pregnancy-induced hypertension during pregnancy. However, three other studies suggest that calcium supplements may reduce the risk. Based on these studies, FDA concludes that it is highly unlikely that calcium supplements reduce the risk of pregnancy-induced hypertension.</p> <p><b>Preeclampsia:</b> Three studies, including a large clinical trial, do not show that calcium supplements reduce the risk of preeclampsia during pregnancy. However, two other studies suggest that calcium supplements may reduce the risk. Based on these studies, FDA concludes that it is highly unlikely that calcium supplements reduce the risk of preeclampsia.</p>

<i>Qualified Health Claims</i>	<i>Eligible Foods</i>	<i>Factors for Exercising Enforcement Discretion</i>	<i>Claim Statements</i>
<p><i>Tomatoes and/or Tomato Sauce &amp; Prostate, Ovarian, Gastric, and Pancreatic Cancers</i></p> <p>Docket No. 2004Q-0201</p> <p>11/08/2005 enforcement discretion letter - American Longevity Petition</p> <p>11/08/2005 enforcement discretion letter - Lycopene Heath Claim Coalition Petition</p>	<p>(1) Cooked, Raw, Dried, or Canned Tomatoes</p> <p>(2) Tomato Sauces that contain at least 8.37 percent salt-free tomato solids</p>		<p><b><i>Tomatoes and/or Tomato Sauce and Prostate Cancer:</i></b> Very limited and preliminary scientific research suggests that eating one-half to one cup of tomatoes and/or tomato sauce a week may reduce the risk of prostate cancer. FDA concludes that there is little scientific evidence supporting this claim.</p> <p><b><i>Tomato Sauce and Ovarian Cancer:</i></b> One study suggests that consumption of tomato sauce two times per week may reduce the risk of ovarian cancer; while this same study shows that consumption of tomatoes or tomato juice had no effect on ovarian cancer risk. FDA concludes that it is highly uncertain that tomato sauce reduces the risk of ovarian cancer.</p> <p><b><i>Tomatoes and Gastric Cancer:</i></b> Four studies did not show that tomato intake reduces the risk of gastric cancer, but three studies suggest that tomato intake may reduce this risk. Based on these studies, FDA concludes that it is unlikely that tomatoes reduce the risk of gastric cancer.</p> <p><b><i>Tomatoes and Pancreatic Cancer:</i></b> One study suggests that consuming tomatoes does not reduce the risk of pancreatic cancer, but one weaker, more limited study suggests that consuming tomatoes may reduce this risk. Based on these studies, FDA concludes that it is highly unlikely that tomatoes reduce the risk of pancreatic cancer.</p>

Qualified Health Claims	Eligible Foods	Factors for Exercising Enforcement Discretion	Claim Statements
<p><b>Unsaturated Fatty Acids from Canola Oil and Reduced Risk of Coronary Heart Disease</b></p> <p>Docket No. 2006Q-0091</p> <p>10/06/2006 enforcement discretion letter</p>	<p>Canola oil (see * for definitions)</p> <p>Vegetable oil spreads, dressings for salads, shortenings, and canola oil-containing foods that contain 4.75 g or more of canola oil per RACC, are low in saturated fat (21 CFR 101.62(c)(2)), are low in cholesterol (21 CFR 101.62(d)(2)), and meet the saturated fat, cholesterol, and sodium disqualifying levels (21 CFR 101.14(a)(4)).</p> <p>Vegetable oil spreads and canola oil-containing foods must also meet the 10% minimum nutrient content requirement (21 CFR 101.14(e)(6)).</p>	<p>Canola oil, vegetable oil spreads, dressings for salads, shortenings and canola-oil containing foods do not need to comply with the total fat disqualifying level in 21 CFR 101.14(a)(4).</p> <p>The requirement that the food contain a minimum of 10 percent of the Daily Value per RACC of at one of the following: vitamin A, vitamin C, iron, calcium, protein, or dietary fiber per not apply to canola oil, dressings for salads, and shortenings.</p> <p>When the total fat disqualifying level is exceeded in vegetable oil spreads, dressings for salads, shortenings, or canola-oil containing foods, the disclosure statement (i.e., See nutrition information for total fat content) must be placed immediately following the claim, with no intervening material, in the same size, typeface, and contrast as the claim itself.</p>	<p>Limited and not conclusive scientific evidence suggests that eating about 1 1/2 tablespoons (19 grams) of canola oil daily may reduce the risk of coronary heart disease due to the unsaturated fat content in canola oil. To achieve this possible benefit, canola oil is to replace a similar amount of saturated fat and not increase the total number of calories you eat in a day. One serving of this product contains [x] grams of canola oil.</p> <p>For purposes of this qualified health claim:</p> <ol style="list-style-type: none"> <li>(1) “Canola oil” means products that are essentially pure canola oil and are labeled as such.</li> <li>(2) “Vegetable oil spread” means margarine (21 CFR 166.110) and margarine-like products, formulated to contain canola oil.</li> <li>(3) “Dressings for salads” means dressings for salads formulated to contain canola oil.</li> <li>(4) “Shortenings” means vegetable oil shortenings, formulated to contain canola oil.</li> <li>(5) “Canola oil-containing foods” means all other foods, such as sauces or baked goods, formulated to contain canola oil, excluding canola oil, vegetable oil spreads, dressings for salads, and shortenings.</li> </ol>

Qualified Health Claims	Eligible Foods	Factors for Exercising Enforcement Discretion	Claim Statements
<p><b>Corn Oil and Corn Oil-Containing Products and a Reduced Risk of Heart Disease</b></p>	<p>Corn oil (see * for definitions)</p> <p>for definitions) blends and shortenings that contain 4 g or more corn oil per RACC, are low in cholesterol (21 CFR 101.62(d) (2)), meet the cholesterol and sodium disqualifying levels (21 CFR 101.14(a) (4)), and do not contain more than 4 g of saturated fat per RACC.</p> <p>Dressings for salads (i.e. salad dressings) that contain 4 g or more corn oil per RACC, are low in cholesterol (21 CFR 101.62(d) (2)), meet the cholesterol and sodium disqualifying levels (21 CFR 101.14(a) (4)), and do not contain more than 4 g of saturated fat per 50 g.</p> <p>Vegetable oil spreads that contain 4 g or more corn oil per RACC, are low in cholesterol (21 CFR 101.62(d) (2)), meet the cholesterol and sodium disqualifying levels (21</p>	<p>Corn oil, vegetable oil blends, vegetable oil spreads, dressings for salads, shortenings and corn-oil containing foods do not need to comply with the total fat disqualifying level in 21 CFR 101.14(a)(4).</p> <p>The requirement that the food comply with the 50 gram-criterion of the saturated fat disqualifying level (21 CFR 101.14(e)(3)) does not apply to corn oil, vegetable oil blends, vegetable oil spreads, and shortenings.</p> <p>The requirement that the food contain a minimum of 10 percent of the Daily Value per RACC of at one of the following: vitamin A, vitamin C, iron, calcium, protein, or dietary fiber per RACC (21 CFR 101.14(e)(6)) does not apply to corn oil, vegetable oil blends, dressings for salads, and shortenings.</p> <p>When the total fat disqualifying level is exceeded in vegetable oil spreads, dressings for salads, shortenings, or corn-oil containing foods, the disclosure statement (i.e., See nutrition information for total fat content) must be placed immediately following the claim, with no intervening material, in the same size, typeface, and contrast as the claim itself.</p> <p>When the food does not meet the definition of low saturated fat (21 CFR 101.62(c)(2)), the disclosure statement (i.e., See nutrition information for saturated fat content) must be placed immediately following the claim, with no intervening material, in the same size, typeface, and contrast as the claim itself.</p> <p>If both of the above two conditions are met, the disclosure statements for total fat and saturated fat can be combined (i.e., See nutrition information for total and saturated fat content).</p>	<p>Very limited and preliminary scientific evidence suggests that eating about 1 tablespoon (16 grams) of corn oil daily may reduce the risk of heart disease due to the unsaturated fat content in corn oil. FDA concludes that there is little scientific evidence supporting this claim. To achieve this possible benefit, corn oil is to replace a similar amount of saturated fat and not increase the total number of calories you eat in a day. One serving of this product contains [x] grams of corn oil.</p> <p>(1) “corn oil” means products that are essentially pure corn oil and are labeled as such</p> <p>(2) “vegetable oil blends” means a blend of two or more vegetable oils formulated to contain corn oil</p> <p>(3) “vegetable oil spread” means margarine (21 CFR 166.110) and margarine-like products formulated to contain corn oil</p> <p>(4) “dressings for salads” means dressings for salads formulated to contain corn oil</p> <p>(5) “shortenings” means vegetable oil shortenings formulated to contain corn oil</p> <p>(6) “corn oil-containing foods” means all other foods, such as sauces or baked goods, formulated to contain corn oil, excluding corn oil, vegetable oil blends, vegetable oil spreads, dressings for salads, and shortenings.</p>

(Continued)

Qualified Health Claims	Eligible Foods	Factors for Exercising Enforcement Discretion	Claim Statements
	<p>CFR 101.14(a)(4), contain at least 10% of either vitamin A, vitamin C, iron, calcium, protein or dietary fiber, and do not contain more than 4 g of saturated fat per RACC.</p>		
	<p>Corn oil-containing foods that contain 4 g or more corn oil per RACC, are low in cholesterol (21 CFR 101.62(d)(2)), meet the cholesterol and sodium disqualifying levels (21 CFR 101.14(a)(4)), contain at least 10% of either vitamin A, vitamin C, iron, calcium, protein or dietary fiber. If the RACC of the corn oil-containing food is greater than 30 g, the food cannot contain more than 4 g of saturated fat per RACC, and if the RACC of the corn oil-containing food is 30 g or less, the food cannot contain more than 4 g of saturated fat per 50 g.</p>		



Qualified Health Claims	Eligible Foods	Factors for Exercising Enforcement Discretion	Claim Statements
<p><b>Selenium &amp; Cancer</b></p> <p>Docket No. FDA-2008-Q-0323</p> <p>06/19/2009 enforcement discretion letter</p> <p>Summary of settlement in Alliance for Natural Health vs. Sebelius</p>	<p>Dietary supplements containing selenium</p>	<p>The qualified health claim about selenium and a reduced risk of bladder cancer can only be used on the label or in labeling of dietary supplements that contain any form of selenium other than selenium sulfide.</p> <p>The qualified health claims about selenium and a reduced risk of prostate cancer or thyroid cancer can only be used on the label or in labeling of dietary supplement that contain selenomethionine.</p> <p>Paragraph 101.14(d)(2)(vii) requires that the dietary supplement bearing claim meet the nutrient content claim definition for high (i.e., 20% or more of the daily value (DV) per RACC). 20% DV for selenium is 14 micrograms.</p>	<p><b>Bladder Cancer</b></p> <p>“One study suggests that selenium intake may reduce the risk of bladder cancer in women. However, one smaller study showed no reduction in risk. Based on these studies, FDA concludes that it is highly uncertain that selenium supplements reduce the risk of bladder cancer in women.”</p> <p><b>Colorectal Cancers</b></p> <p>"Selenium may reduce the risk of colorectal cancer. Scientific evidence concerning this claim is inconclusive. Based on its review, FDA does not agree that selenium may reduce the risk of colorectal cancer."</p> <p>"Selenium may reduce the risk of colon and rectal cancer. Scientific evidence concerning this claim is inconclusive. Based on its review, FDA does not agree that selenium may reduce the risk of colon and rectal cancer."</p> <p><b>Colon Cancer</b></p> <p>"Selenium may reduce the risk of colon cancer. Scientific evidence concerning this claim is inconclusive. Based on its review, FDA does not agree that selenium may reduce the risk of colon cancer."</p> <p><b>Prostate Cancer</b></p> <p>“Two weak studies suggest that selenium intake may reduce the risk of prostate cancer. However, four stronger studies and three weak studies showed no reduction in risk. Based on these studies, FDA concludes that it is highly unlikely that selenium supplements reduce the risk of prostate cancer.”</p> <p>"Selenium may reduce the risk of prostate cancer. Scientific evidence concerning this claim is inconclusive. Based on its review, FDA does not agree that selenium may reduce the risk of prostate cancer."</p> <p><b>Several Cancers</b></p> <p>"Selenium may reduce the risk of bladder, colon, prostate, rectal and thyroid cancers. Based on its review, FDA does not agree that selenium may reduce the risk of these cancers."</p>

Qualified Health Claims	Eligible Foods	Factors for Exercising Enforcement Discretion	Claim Statements
<b><i>Antioxidant Vitamins &amp; Cancer</i></b>	Dietary supplements containing vitamin E and/or vitamin C	The supplement does not recommend or suggest in its labeling, or under ordinary conditions of use, a daily intake of vitamin C above 1000 mg per day or above 670 mg of alpha-tocopherol per day for vitamin E.	<p><b><i>Thyroid Cancer</i></b></p> <p>“One weak, small study suggests that selenium intake may reduce the risk of thyroid cancer. Based on this study, FDA concludes that it is highly uncertain that selenium supplements reduce the risk of thyroid cancer.”</p>
Docket No. FDA-2008-Q-0299		Paragraph 101.14(d)(2)(vii) requires that the food bearing the claim meet the nutrient content claim definition for high (i.e., 20% or more of the daily value (DV) per RACC). 20% DV for vitamin C is 12 mg; 20% DV for vitamin E is 6 IU*.	<p><b><u>Vitamin C</u></b></p> <p><b><i>Gastric (Stomach) Cancer</i></b></p> <p>“One weak study and one study with inconsistent results suggest that vitamin C supplements may reduce the risk of gastric cancer. Based on these studies, FDA concludes that it is highly uncertain that vitamin C supplements reduce the risk of gastric cancer.”</p> <p>“Vitamin C may reduce the risk of gastric cancer although the FDA has concluded that there is very little scientific evidence for this claim.”</p> <p>“Vitamin C may reduce the risk of gastric cancer. FDA has concluded that there is very little scientific evidence for this claim.”</p>
06/19/2009 enforcement discretion letter			
Summary of settlement in Alliance for Natural Health vs. Sebelius			<p><b><u>Vitamin E</u></b></p> <p><b><i>Bladder Cancer</i></b></p> <p>“One small study suggests that vitamin E supplements may reduce the risk of bladder cancer. However, two small studies showed no reduction of risk. Based on these studies, FDA concludes that it is highly unlikely that vitamin E supplements reduce the risk of bladder cancer.”</p> <p>“Vitamin E may reduce the risk of bladder cancer although the FDA has concluded that there is very little scientific evidence for this claim.”</p> <p>“Vitamin E may reduce the risk of bladder cancer. FDA has concluded that there is very little scientific evidence for this claim.”</p>

Qualified Health Claims	Eligible Foods	Factors for Exercising Enforcement Discretion	Claim Statements
<p>100% Whey-Protein Partially Hydrolyzed Infant Formula &amp; Atopic Dermatitis</p> <p>Docket No. FDA-2009-Q-0301</p> <p>05/24/2011 enforcement discretion letter</p>	<p>100% Whey-Protein Partially Hydrolyzed Infant Formula</p>	<p>The following language is placed immediately adjacent to and directly beneath the claim:</p> <p>"Partially hydrolyzed formulas <b>should not be fed to infants who are allergic to milk or to infants with existing milk allergy symptoms.</b> If you suspect your baby is already allergic to milk, or if your baby is on a special formula for the treatment of allergy, your baby's care and feeding choices should be under a doctor's supervision."</p>	<p><b>Colorectal Cancer</b></p> <p>"Two weak studies and one study with inconsistent results suggest that vitamin E supplements may reduce the risk of colorectal cancer. However, another limited study showed no reduction of risk. Based on these studies, FDA concludes that it is highly unlikely that vitamin E supplements reduce the risk of colorectal cancer."</p> <p>"Vitamin E may reduce the risk of colorectal cancer although the FDA has concluded that there is very little scientific evidence for this claim."</p> <p>"Vitamin E may reduce the risk of colorectal cancer. FDA has concluded that there is very little scientific evidence for this claim."</p> <p><b>Renal Cell Cancer</b></p> <p>"One weak and limited study suggests that vitamin E supplements may reduce the risk of renal cell cancer. FDA concludes that it is highly uncertain that vitamin E supplements reduce the risk of renal cell cancer."</p> <p>"Vitamin E may reduce the risk of renal cancer although the FDA has concluded that there is very little scientific evidence for this claim."</p> <p>"Vitamin E may reduce the risk of renal cancer. FDA has concluded that there is very little scientific evidence for this claim."</p> <p>(1) "Very little scientific evidence suggests that, for healthy infants who are not exclusively breastfed and who have a family history of allergy, feeding a 100 % Whey-Protein Partially Hydrolyzed infant formula from birth up to 4 months of age instead of a formula containing intact cow's milk proteins may reduce the risk of developing atopic dermatitis throughout the 1st year of life and up to 3 years of age."</p> <p style="text-align: right;"><i>(Continued)</i></p>

Qualified Health Claims	Eligible Foods	Factors for Exercising Enforcement Discretion	Claim Statements
			<p>(2) "Little scientific evidence suggests that, for healthy infants who are not exclusively breastfed and who have a family history of allergy, feeding a 100 % Whey-Protein Partially Hydrolyzed infant formula from birth up to 4 months of age instead of a formula containing intact cow's milk proteins may reduce the risk of developing atopic dermatitis throughout the 1st year of life."</p>
			<p>(3) "For healthy infants who are not exclusively breastfed and who have a family history of allergy, feeding a 100% Whey-Protein Partially Hydrolyzed infant formula from birth up to 4 months of age instead of a formula containing intact cow's milk proteins may reduce the risk of developing atopic dermatitis throughout the 1st year of life and up to 3 years of age. FDA has concluded that the relationship between 100% Whey-Protein Partially Hydrolyzed infant formulas and the reduced risk of atopic dermatitis is uncertain, because there is very little scientific evidence for the relationship."</p>
			<p>(4) "For healthy infants who are not exclusively breastfed and who have a family history of allergy, feeding a 100% Whey-Protein Partially Hydrolyzed infant formula from birth up to 4 months of age instead of a formula containing intact cow's milk proteins may reduce the risk of developing atopic dermatitis throughout the 1st year of life. FDA has concluded that the relationship between 100% Whey-Protein Partially Hydrolyzed infant formulas and the reduced risk of atopic dermatitis is uncertain, because there is little scientific evidence for the relationship."</p>

\* Based upon conversion factors identified in the 2000 IOM Report, this equates to about 1500 IU of natural vitamin E or about 2200 IU of synthetic (all racemic) vitamin E. The conversion factors are as follows: (mg of alphanatocopherol in food, fortified food or multivitamin = 0.67 X IU of the RRR- $\alpha$ -tocopherol or = 0.45 X IU of the all rac- $\alpha$ -tocopherol) (IOM, 2000, Chapter 6).

## 13. APPENDIX E: ADDITIONAL FDA RESOURCES

The following titles are available on FDA's web site.

### *A Labeling Guide for Restaurants and Other Retail Establishments Selling Away From-Home Foods*

<http://www.fda.gov/Food/GuidanceComplianceRegulatoryInformation/GuidanceDocuments/FoodLabelingNutrition/ucm053455.htm>

### *FDA Nutrition Labeling Manual: A Guide for Developing and Using Databases*

Generic instructions for developing and preparing an acceptable database when valid estimates of nutrient content and variation are not available for the food (single or mixed products) to be labeled.

<http://www.fda.gov/Food/GuidanceComplianceRegulatoryInformation/GuidanceDocuments/FoodLabelingNutrition/ucm063113.htm>

### *Small Business Nutrition Labeling Exemption*

Sample exemption application form and related information.

<http://www.fda.gov/Food/GuidanceComplianceRegulatoryInformation/GuidanceDocuments/FoodLabelingNutrition/ucm053857.htm>

The following titles contain more information about Federal food laws and regulations. They can be obtained from the Government Printing Office.

### *Food and Drug Administration Modernization Act of 1997, Public Law 105-115 GPO (Stock #869-033-00116-9)*

Book. Amends the Federal Food, Drug, and Cosmetic Act and the Public Health Service Act to Improve the Regulation of Food, Drugs, Devices, and Biological Products.

<http://www.fda.gov/RegulatoryInformation/Legislation/FederalFoodDrugandCosmeticActFDCAct/SignificantAmendmentstotheFDCAct/FDAMA/FullTextofFDAMAlaw/default.htm>

### *Compilation of Laws Enforced by the United States Food and Drug Administration and Related Statutes, V. 1 (1996)*

GPO (Stock #017-012-00378-8) Printed in 1996, this looseleaf (with binder) is a compilation of the Federal Food, Drug, and Cosmetic Act; Public Health Service Act; Fair Packaging and Labeling Act; Miscellaneous Provisions Relating to Orphan Drugs; Administrative Procedures Act; Federal Committee Act; and Lead-Based Paint Poisoning Prevention Act.

<http://www.fda.gov/RegulatoryInformation/Legislation/FederalFoodDrugandCosmeticActFDCAct/default.htm> and  
<http://www.fda.gov/RegulatoryInformation/Legislation/ucm153119.htm>

### *Title 21, Code of Federal Regulations*

GPO (order by title and part) Contains regulations which FDA enforces. Those applicable to the food industry are:

- Part 1 to 99: General regulations for the enforcement of the Federal Food, Drug, and Cosmetic Act and the Fair Packaging and Labeling Act. Color Additives.
- Part 100 to 169: Food labeling, food standards, good manufacturing practices for foods, low-acid canned foods, and acidified foods.
- Part 170 to 199: Food additives.
- Part 800 to 1299: Regulations under Federal Import Milk Act, the Federal Tea Importation Act, the Federal Caustic Poison Act, and regulations for control of communicable diseases and interstate conveyance sanitation.

<http://www.accessdata.fda.gov/scripts/cdrh/cfdocs/cfcfr/cfrsearch.cfm>

### *For price and ordering information*

Superintendent of Documents

Government Printing Office

Washington, DC. 20402

Telephone: (202) 512-1800

(Check the telephone book for GPO branches in your city)

## 14. APPENDIX F: CALCULATE THE PERCENT DAILY VALUE FOR THE APPROPRIATE NUTRIENTS

There are two sets of reference values for reporting nutrients in nutrition labeling: 1) Daily Reference Values (DRVs) and 2) Reference Daily Intakes (RDIs). These values assist consumers in interpreting information about the amount of a nutrient that is present in a food and in comparing nutritional values of food products. DRVs are established for adults and children four or more years of age, as are RDIs, with the exception of protein. DRVs are provided for total fat, saturated fat, cholesterol, total carbohydrate, dietary fiber, sodium, potassium, and protein. RDIs are provided for vitamins and minerals and for protein for children less than four years of age and for pregnant and lactating women. In order to limit consumer confusion, however, the label includes a single term (i.e., Daily Value (DV)), to designate both the DRVs and RDIs. Specifically, the label includes the % DV, except that the % DV for protein is not required unless a protein claim is made for the product or if the product is to be used by infants or children under four years of age. The following table lists the DVs based on a caloric intake of 2,000 calories, for adults and children four or more years of age.

<i>Food Component</i>	<i>DV</i>
Total Fat	65 grams (g)
Saturated Fat	20 g
Cholesterol	300 milligrams (mg)
Sodium	2,400 mg
Potassium	3,500 mg
Total Carbohydrate	300 g
Dietary Fiber	25 g
Protein	50 g
Vitamin A	5,000 International Units (IU)
Vitamin C	60 mg
Calcium	1,000 mg
Iron	18 mg
Vitamin D	400 IU
Vitamin E	30 IU
Vitamin K	80 micrograms (µg)
Thiamin	1.5 mg
Riboflavin	1.7 mg

<i>Food Component</i>	<i>DV</i>
Niacin	20 mg -
Vitamin B6	2 mg -
Folate	400 µg -
Vitamin B12	6 µg
Biotin	300 µg
Pantothenic acid	10 mg
Phosphorus	1,000 mg
Iodine	150 µg
Magnesium	400 mg
Zinc	15 mg
Selenium	70 µg
Copper	2 mg
Manganese	2 mg
Chromium	120 µg -
Molybdenum	75 µg -
Chloride	3,400 mg -

In order to calculate the % DV, determine the ratio between the amount of the nutrient in a serving of food and the DV for the nutrient. That is, divide either the actual (unrounded) quantitative amount or the declared (rounded) amount (see next section) by the appropriate DV. When deciding whether to use the unrounded or rounded value, consider the amount that will provide the greatest consistency on the food label and prevent unnecessary consumer confusion. The nutrients in the table above are listed in the order in which they are required to appear on a label in accordance with 21 CFR 101.9(c). This list includes only those nutrients for which a DRV has been established in 21 CFR 101.9(c)(9) or a RDI in 21 CFR 101.9(c)(8)(iv).

## 15. APPENDIX G: DAILY VALUES FOR INFANTS, CHILDREN LESS THAN 4 YEARS OF AGE, AND PREGNANT AND LACTATING WOMEN

These values have not been codified, but have been published in the Federal Register to provide guidance to manufacturers for the nutrients listed (58 FR 2206 at 2213; January 6, 1993). The abbreviation "IU" is used for International Units, "mg" for milligrams, and "mcg" for micrograms. The abbreviation "µg" may also be used for micrograms. Also, the agency has modified the units of measure for four nutrients. Calcium and phosphorus values are expressed in mg and biotin and folate values in mcg (60 FR 67164 to 67174).

<i>Vitamin or Mineral</i>	<i>Infants</i>	<i>Less than 4 Years</i>	<i>Pregnant and Lactating Women</i>	<i>Units of Measure</i>
Vitamin A	1,500	2,500	8,000	IU
Vitamin C	35	40	60	mg
Calcium	600	800	1,300	mg
Iron	15	10	18	mg
Vitamin D	400	400	400	IU
Vitamin E	5	10	30	IU
Thiamin	0.5	0.7	1.7	mg
Riboflavin	0.6	0.8	2.0	mg
Niacin	8	9	20	mg
Vitamin B6	0.4	0.7	2.5	mg
Folate	100	200	800	mcg
Vitamin B12	2	3	8	mcg
Biotin	50	150	300	mcg
Pantothenic acid	3	5	10	mg
Phosphorus	500	800	1,300	mg
Iodine	45	70	150	mcg
Magnesium	70	200	450	mg
Zinc	5	8	15	mg
Copper	0.6	1.0	2.0	mg



## 16. APPENDIX H: ROUNDING THE VALUES ACCORDING TO FDA ROUNDING RULES

The following table provides rounding rules for declaring nutrients on the nutrition label or in labeling:

<i>Nutrient</i>	<i>Increment Rounding</i>	<i>Insignificant Amount</i>
Calories (1)	< 5 cal - express as 0	< 5 cal
Calories from Fat (1)(ii)	≤50 cal - express to nearest 5 cal increment	
Calories from Saturated Fat (1)(iii)	> 50 cal - express to nearest 10 cal increment	
Total Fat (2)	< .5 g - express as 0	< .5 g
Saturated Fat (2)(i)	< 5 g - express to nearest .5g increment	
Trans Fat (2)(ii)	≥5 g - express to nearest 1 g increment	
Polyunsaturated Fat (2)(iii)		
Monounsaturated Fat (2)(iv)		
Cholesterol (3)	< 2 mg - express as 0 2 - 5 mg - express as “less than 5 mg “ > 5 mg - express to nearest 5 mg increment	< 2 mg
Sodium (4)	< 5 mg - express as 0	< 5 mg
Potassium (5)	5 - 140 mg - express to nearest 5 mg increment > 140 mg - express to nearest 10 mg increment	
Total Carbohydrate (6)	< .5 g - express as 0	< 1 g
Dietary Fiber (6)(i)	< 1 g - express as “Contains less than 1 g” or “less than 1 g”	
Sugars (6)(ii)	≥1 g - express to nearest 1 g increment	
Soluble and Insoluble Fiber; Sugars (6)(i)(A)&(B)&(6)(ii)	< .5 g - express as 0	< .5 g
Sugar Alcohol (6)(iii)	< 1 g - express as “Contains less than 1 g “ or “less than 1 g”	
Other Carbohydrate (6)(iv)	≥1 g - express to nearest 1 g increment	
Protein (7)	< .5 g - express as 0 < 1 g - express as “Contains less than 1 g” or “less than 1 g” or to 1 g if .5 g to < 1 g ≥1 g - express to nearest 1 g increment	< 1 g
When declaring nutrients other than vitamins and minerals that have RDIs as a % DV (8)(iii)	express to nearest 1% DV increment	< 1% DV

(Continued)

<i>Nutrient</i>	<i>Increment Rounding</i>	<i>Insignificant Amount</i>
Vitamins & Minerals (express as % DV)	<p>&lt; 2% of RDI may be expressed as:</p> <p>(1) 2% DV if actual amount is 1% or more</p> <p>(2) 0</p> <p>(3) an asterisk that refers to statement “Contains less than 2% of the Daily Value of this (these) nutrient(s) “</p> <p>(4) for Vit A, C, calcium, iron: statement “Not a significant source of _____ (listing the vitamins and minerals omitted)”</p> <p>≤10% of RDI - express to nearest 2% DV increment &gt; 10% - 50% of RDI - express to nearest 5% DV increment &gt; 50% of RDI - express to nearest 10% DV increment</p>	< 2% RDI
Beta-Carotene (express as % DV)	<p>≤10% of RDI for vitamin A- express to nearest 2% DV increment &gt; 10% - 50% of RDI for vitamin A- express to nearest 5% DV increment &gt; 50% of RDI for vitamin A- express to nearest 10% DV increment</p>	

To express nutrient values to the nearest 1 g increment, for amounts falling exactly halfway between two whole numbers or higher (e.g., 2.5 to 2.99 g), round up (e.g., 3 g). For amounts less than halfway between two whole numbers (e.g, 2.01 g to 2.49 g), round down (e.g., 2 g).

When rounding % DV for nutrients other than vitamins and minerals, when the % DV values fall exactly halfway between two whole numbers or higher (e.g., 2.5 to 2.99), the values round up (e.g., 3 %). For values less than halfway between two whole numbers (e.g., 2.01 to 2.49), the values round down (e.g., 2%).



# **U.S. Food and Drug Administration**

**Guidance for Industry**

---

U.S. Department of Health  
and Human Services

---

Food and Drug Administration

---

Center for Food Safety and Applied Nutrition

---

---

---

---

---

---

---

---

---

---

---

---

---

January 2013

Food and Drug Administration  
5100 Paint Branch Parkway  
College Park, MD 20740

*[www.fda.gov/FoodLabelingGuide](http://www.fda.gov/FoodLabelingGuide)*